

# DEHN FILLINGS OF KNOT MANIFOLDS CONTAINING ESSENTIAL TWICE-PUNCTURED TORI

STEVEN BOYER, CAMERON MCA. GORDON, AND XINGRU ZHANG

February 18, 2021

ABSTRACT. We show that if a hyperbolic knot manifold  $M$  contains an essential twice-punctured torus  $F$  with boundary slope  $\beta$  and admits a filling with slope  $\alpha$  producing a Seifert fibred space, then the distance between the slopes  $\alpha$  and  $\beta$  is less than or equal to 5 unless  $M$  is the exterior of the figure eight knot. The result is sharp; the bound of 5 can be realized on infinitely many hyperbolic knot manifolds. We also determine distance bounds in the case that the fundamental group of the  $\alpha$ -filling contains no non-abelian free group. The proofs are divided into the four cases  $F$  is a semi-fibre,  $F$  is a fibre,  $F$  is non-separating but not a fibre, and  $F$  is separating but not a semi-fibre, and we obtain refined bounds in each case.

## 1. INTRODUCTION

This is the third in a series of papers in which we investigate the following conjecture of the second named author ([Go2, Conjecture 3.4]). Throughout we assume that  $M$  is a *hyperbolic knot manifold*. That is,  $M$  is a compact, connected, orientable 3-manifold with torus boundary whose interior has a complete finite volume hyperbolic structure.

**Conjecture 1.1.** (C. McA. Gordon) *Suppose that  $M$  is a hyperbolic knot manifold and  $\alpha, \beta$  are slopes on  $\partial M$  such that  $M(\beta)$  is a toroidal manifold and  $M(\alpha)$  is a Seifert manifold. If  $\Delta(\alpha, \beta) > 5$ , then  $M$  is the figure eight knot exterior.*

Recall that if  $M$  is the exterior of the figure eight knot then  $M(\gamma)$  is hyperbolic unless  $\gamma \in \{\infty, 0, \pm 1, \pm 2, \pm 3, \pm 4\}$ . Moreover,  $M(\infty) \cong S^3$ ,  $M(0)$  is a torus bundle,  $M(\pm 4)$  are toroidal, and  $M(\pm 1)$ ,  $M(\pm 2)$  and  $M(\pm 3)$  are Seifert manifolds.

We note that 6 is the threshold distance characterising the figure eight knot exterior: there are infinitely many triples  $(M; \alpha, \beta)$  where  $M$  is a hyperbolic knot manifold with Seifert and toroidal filling slopes  $\alpha$  and  $\beta$  such that  $\Delta(\alpha, \beta) = 5$ . See Example 2.1.

Suppose that  $\alpha$  and  $\beta$  are slopes on  $\partial M$  such that  $M(\beta)$  is toroidal and  $M(\alpha)$  is a Seifert manifold. In Proposition 3.3 of [BGZ3] we showed that  $\Delta(\alpha, \beta) \leq 3$  if one of  $M(\alpha)$  or  $M(\beta)$  is reducible. Further, in Theorem 1.2 of [BGZ3] we showed that if  $M(\alpha)$  is toroidal then  $\Delta(\alpha, \beta) \leq 4$  (see Theorem 1.4 below). Thus we may assume that both  $M(\alpha)$  and  $M(\beta)$  are

---

Steven Boyer was partially supported by NSERC grant RGPIN 9446-2008.

Cameron Gordon was partially supported by NSF grant DMS-0906276.

2000 MATHEMATICS SUBJECT CLASSIFICATION. PRIMARY 57M25, 57M50, 57M99

irreducible, and  $M(\alpha)$  is atoroidal. In particular,  $M(\alpha)$  is a *small Seifert manifold*, that is, it admits a Seifert structure with base orbifold of the form  $S^2(a, b, c)$  where  $a, b, c \geq 1$ .

Since  $M$  is hyperbolic and  $M(\beta)$  is toroidal,  $M$  contains an essential punctured torus  $F$  with non-empty boundary of slope  $\beta$ . Let  $m$  be the minimum value of  $|\partial F|$  over all such  $F$ . In [BGZ2] we verified the conjecture in the case that  $m \geq 3$  and  $M$  admits no punctured torus of boundary slope  $\beta$  which is a fibre or semi-fibre. In [BGZ3] we proved the conjecture when  $M$  contains an essential once-punctured torus. In the present paper we consider the case  $m = 2$ . Note that this is the case that arises in the  $\pm 4$ -surgeries on the figure eight knot.

Here is our main result.

**Theorem 1.2.** *Let  $M$  be a hyperbolic knot manifold which contains an essential twice-punctured torus  $F$  with boundary slope  $\beta$ , and let  $\alpha$  be a slope on  $\partial M$  such that  $M(\alpha)$  is an irreducible small Seifert manifold. If  $\Delta(\alpha, \beta) > 5$  then  $M$  is the exterior of the figure eight knot. More precisely:*

- (1) *If  $F$  is a fibre in  $M$ , then  $\Delta(\alpha, \beta) \leq 3$ .*
- (2) *If  $F$  is a semi-fibre in  $M$ , then  $\Delta(\alpha, \beta) \leq 4$ .*
- (3) *If  $F$  is non-separating in  $M$ , though not a fibre, then  $\Delta(\alpha, \beta) \leq 5$ .*
- (4) *If  $F$  is separating in  $M$ , though not a semi-fibre, and if  $\Delta(\alpha, \beta) > 5$ , then  $M$  is the exterior of the figure eight knot.*

Theorem 1.2 combines with Proposition 3.3 and Theorems 1.2 and 1.3 of [BGZ3], and Theorem 2.7 of [BGZ2], to give:

**Corollary 1.3.** *Let  $M$  be a hyperbolic knot manifold that is not an  $m$ -punctured torus bundle,  $m \geq 3$ , or an  $m$ -punctured torus semi-bundle,  $m \geq 4$ . Then Conjecture 1.1 holds for  $M$ .*

The triples  $(M; \alpha, \beta)$  where  $M(\alpha)$  and  $M(\beta)$  are toroidal and  $\Delta(\alpha, \beta) \geq 4$  have been classified, by Gordon [Go1] when  $\Delta(\alpha, \beta) \geq 6$  and by Gordon and Wu [GW] when  $\Delta(\alpha, \beta) = 4$  or  $5$ . Using this, the following result, which deals with the case where  $M(\beta)$  is toroidal and  $M(\alpha)$  is toroidal Seifert, was proved in [BGZ3]. Here  $N$  is the 3-chain link (shown in Figure 1) exterior (also called the *magic manifold*), and slopes are parametrised in the usual way for exteriors of links in  $S^3$ .

**Theorem 1.4.** ([BGZ3, Theorem 1.2]). *Let  $M$  be a hyperbolic knot manifold with slopes  $\alpha$  and  $\beta$  on  $\partial M$  such that  $M(\beta)$  is toroidal and  $M(\alpha)$  is a toroidal Seifert manifold. Then*

- (1)  $\Delta(\alpha, \beta) \leq 4$ , and
- (2)  $\Delta(\alpha, \beta) = 4$  if and only if  $(M; \alpha, \beta) \cong (N(-1/2, -1/2); -4, 0)$ .

**Remark 1.5.** There is a mistake in the proof of [BGZ3, Lemma 2.5], in the case of  $N(-4) \cong M_3$ . Namely, in the table just before Lemma 2.5, in the list of exceptional slopes for  $N(-4)$ , “ $-1/2$ ” should be “ $-5/2$ ”. Similarly, in part (c) of Lemma 2.5, “ $N(-4, -1/2, \gamma)$ ” should be

“ $N(-4, -5/2, \gamma)$ ”, and “ $\gamma = -1/2$ ” should be “no  $\gamma$ ”. Finally, in the first sentence after the proof of Lemma 2.5, “parts (a) and (c)” should be “part (a)”, and the phrase “and  $N(-4)$ , respectively” should be deleted.

We also consider the case that  $M(\alpha)$  is *very small*, in other words, its fundamental group does not contain a non-abelian free group. In this case, consideration of the JSJ decomposition of  $M(\alpha)$  shows that it is either a torus bundle over the circle, a torus semi-bundle over an interval, or a Seifert manifold whose base orbifold has non-negative Euler characteristic. As in the proof of Theorem 1.4, the results of [Go1] and [GW] can be used to deal with the cases where  $M(\alpha)$  is a torus bundle or semi-bundle. These are described in Theorems 1.6 and 1.7 below. In these theorems,  $Wh$  denotes the exterior of the Whitehead link (shown in Figure 1), with slopes again parametrised in the usual way for link exteriors in  $S^3$ .

**Theorem 1.6.** *Let  $M$  be a hyperbolic knot manifold with slopes  $\alpha$  and  $\beta$  on  $\partial M$  such that  $M(\beta)$  is toroidal and  $M(\alpha)$  is a torus bundle. Then*

- (1)  $\Delta(\alpha, \beta) \leq 4$ , and
- (2)  $\Delta(\alpha, \beta) = 4$  if and only if  $(M; \alpha, \beta) \cong (Wh(n); 0, -4)$ ,  $n \in \mathbb{Z}$ ,  $n \neq -4, -3, -2, -1, 0$ .

In part (2) of Theorem 1.6, note that  $Wh(1)$  is the figure eight knot exterior and  $(Wh(1); 0, 4) \cong (Wh(1); 0, -4)$ .

**Theorem 1.7.** *Let  $M$  be a hyperbolic knot manifold with slopes  $\alpha$  and  $\beta$  on  $\partial M$  such that  $M(\beta)$  is toroidal and  $M(\alpha)$  is a torus semi-bundle. Then*

- (1)  $\Delta(\alpha, \beta) \leq 4$ , and
- (2)  $\Delta(\alpha, \beta) = 4$  if and only if  $(M; \alpha, \beta) \cong (Wh(-4n/(2n+1)); -4, 0)$ ,  $n \in \mathbb{Z}$ ,  $n \neq -1, 0$ .

In Corollary 1.3 we had to exclude the cases where  $M$  is either an  $m$ -punctured torus bundle,  $m \geq 3$ , or an  $m$ -punctured torus semi-bundle,  $m \geq 4$ . If we assume that  $M(\alpha)$  is very small Seifert, then we can include the latter case, and we can also include the former case if  $M(\alpha)$  is of  $C$ - or  $D$ -type (whose definitions can be found at the beginning of §7.1).

**Theorem 1.8.** *Let  $M$  be a hyperbolic knot manifold with slopes  $\alpha$  and  $\beta$  on  $\partial M$  such that  $M(\beta)$  is toroidal and  $M(\alpha)$  is a very small Seifert manifold. If  $M(\alpha)$  is not of  $C$ - or  $D$ -type, assume that  $M$  is not an  $m$ -punctured torus bundle,  $m \geq 3$ . Then  $\Delta(\alpha, \beta) \leq 5$ .*

Theorem 1.8 is best possible; see Example 2.2.

The proofs of the four parts of Theorem 1.2 are independent and are dealt with in separate parts of the paper.

Here is how the paper is organised.

In §2 we show that Theorem 1.2 is sharp by producing an infinite family hyperbolic knot manifolds each of which contains an essential twice punctured torus of boundary slope  $\beta$  and

admits a small Seifert filling slope  $\alpha$  such that  $\Delta(\alpha, \beta) = 5$ . Theorems 1.6 and 1.7 are proven in §3. Sections 4 and 5 contain assumptions, reductions and background material to be applied later in the paper. In §6 we construct curves in the  $PSL_2(\mathbb{C})$ -character varieties of certain amalgams of triangle groups which will play an essential part in the proof of Theorem 1.2. The first two assertions of this theorem are proven in §7 and §8. The relative JSJ method for studying Dehn fillings introduced in [BCSZ1] and further developed in [BGZ2] is outlined in §9 and used to prove the third assertion of Theorem 1.2 in §10. Further background material for dealing with the last assertion is contained in §11 and §13 while §14 provides sufficient conditions for recognizing that  $M$  is the figure eight knot exterior when  $\Delta(\alpha, \beta) > 5$ . The proof of the final assertion of Theorem 1.2 is then dealt with in §12, 15, 17, 18 and 19. The proof of Theorem 1.8 is given in §20.

**Acknowledgements.** The authors would like to thank Bruno Martelli for graciously performing computer calculations related to an earlier version of the paper, and the referee for their careful reading of the manuscript and especially for pointing out flaws in our original proofs of Lemmas 7.5 and 8.2.

## 2. EXAMPLES

In this section we examine the sharpness of the theorems in the introduction. We assume throughout that  $M$  is a hyperbolic knot manifold which contains an essential twice-punctured torus  $F$  of boundary slope  $\beta$  and  $\alpha$  is a slope on  $\partial M$  such that  $M(\alpha)$  either Seifert fibred or very small.

We use  $N$  to denote the exterior of the hyperbolic 3-chain link (shown in Figure 1) with the coordinates on  $\partial N$  as given in [MP].



FIGURE 1. The Whitehead link and the 3 chain link

The following example shows that 6 is the threshold distance characterising the figure eight knot exterior in that there are infinitely many hyperbolic knot manifolds which contain an essential twice punctured torus of boundary slope  $\beta$  and admit a small Seifert filling slope  $\alpha$  such that  $\Delta(\alpha, \beta) = 5$ .

**Example 2.1.** For each integer slope  $n \neq 0, -1, -2, -3$ , the manifold  $N(-\frac{3}{2}, n)$  is a hyperbolic knot manifold. This fact follows from [MP, Theorems 1.1 and 1.2]. Now  $N(-\frac{3}{2}, n, -\frac{5}{2})$  is a toroidal manifold and  $N(-\frac{3}{2}, n, 0)$  is a small Seifert fibred manifold, by [MP, Table A.6]. So

we just need to verify that  $N(-\frac{3}{2}, n)$  contains an essential twice-punctured torus of boundary slope  $-\frac{5}{2}$ . To this end, first note that the manifold  $N(-\frac{3}{2})$  is hyperbolic by [MP, Theorem 1.1]. Next note that  $N(-\frac{3}{2}, -\frac{5}{2})$  and  $N(-\frac{3}{2}, 0)$  are both toroidal manifolds ([MP, Table 1]). Hence by [GW2, Theorem 1.1],  $N(-\frac{3}{2})$  is the exterior of the Whitehead sister link (shown in [GW2, Figure 7.1 (c)]) since it is the only hyperbolic link exterior of two boundary components which admits two toroidal Dehn fillings on one of its boundary components at distance 5. Furthermore by [MP, Table 1],  $N(-\frac{3}{2}, -\frac{5}{2})$  has a unique essential torus  $T$  (up to isotopy) and this torus  $T$  splits the manifold into two pieces, one is Seifert fibred over a disk with two cone points and the other is Seifert fibred over an annulus with one cone point. Now by [GW2, Theorem 1.1], the essential torus  $T$  in  $N(-\frac{3}{2}, -\frac{5}{2})$  can be arranged to intersect the third boundary torus of  $N$  in two components of slope  $-\frac{5}{2}$ . Moreover by the unique torus decomposition of the toroidal manifold  $N(-\frac{3}{2}, n, -\frac{5}{2})$  given in [MP, Table A.6], one can see clearly that the torus  $T$  remains essential in  $N(-\frac{3}{2}, n, -\frac{5}{2})$ . As  $T$  intersects the boundary torus of  $N(-\frac{3}{2}, n)$  in two components (minimally possible) of slope  $-\frac{5}{2}$ , its restriction on  $N(-\frac{3}{2}, n)$  is an essential twice-punctured torus of boundary slope  $-\frac{5}{2}$ .

The following example shows that Theorem 1.8 is sharp.

**Example 2.2.** Taking  $n = -4$  or  $-5$  in Example 2.1, the Seifert filling on  $N(-\frac{3}{2}, n)$  with slope 0 has finite fundamental group (of  $T$ -type or  $I$ -type respectively) while the slope 0 has distance 5 to the essential twice-punctured torus of boundary slope  $-\frac{5}{2}$ . Note that  $N(-\frac{3}{2}, -4)$  is the figure eight sister manifold.

### 3. PROOF OF THEOREMS 1.6 AND 1.7

By [Go1], there are four triples  $(M; \alpha, \beta)$  with  $M(\alpha)$  and  $M(\beta)$  toroidal and  $\Delta(\alpha, \beta) \geq 6$ . In all cases one readily checks that neither  $M(\alpha)$  nor  $M(\beta)$  is a torus bundle or semi-bundle. For example, one may proceed as follows. The manifolds  $M$  are  $Wh(1), Wh(-5), Wh(2)$  and  $Wh(-5/2)$ . Now  $Wh \cong N(1)$ , and with respect to the slope parametrizations described above,  $Wh(r) \cong N(1, r+1)$ . An examination of Tables A.2 and A.3 in [MP] shows that none of the toroidal fillings in question is a torus bundle or semi-bundle.

For  $\Delta = 4$  or  $5$ , the triples  $(M; \alpha, \beta)$  with  $M(\alpha)$  and  $M(\beta)$  toroidal are determined in [GW]. There are 14 hyperbolic manifolds  $M_i$ ,  $1 \leq i \leq 14$ , each with a pair of toroidal filling slopes  $\alpha_i, \beta_i$  at distance 4 or 5, where  $M_1, M_2, M_3$  and  $M_{14}$  have two (torus) boundary components, and the others, one. It is shown in [GW] that a hyperbolic knot manifold has two toroidal filling slopes  $\alpha$  and  $\beta$  at distance 4 or 5 if and only if either  $(M; \alpha, \beta) \cong (M_i; \alpha_i, \beta_i)$  for some  $4 \leq i \leq 13$ , or  $(M; \alpha, \beta) \cong (M_i(\gamma); \alpha_i, \beta_i)$ , for  $i = 1, 2, 3$  or  $14$  and some slope  $\gamma$  on the second boundary component of  $M_i$ .

First, one sees from [GW, Lemma 22.2] that for  $6 \leq i \leq 13$ , neither  $M_i(\alpha_i)$  nor  $M_i(\beta_i)$  is a torus bundle or semi-bundle.

Next, the proof of [BGZ3, Lemma 2.3] shows that neither  $M_4(\alpha_4)$  nor  $M_4(\beta_4)$  is a torus bundle or semi-bundle.

For  $M_5$ , one can argue as follows. By [L2, Section 6],  $M_5 \cong N(1, -1/3)$ , the toroidal filling slopes being  $-4$  and  $1$ . Then [MP, Table A.4] shows that neither  $N(1, -1/3, -4)$  nor  $N(1, -1/3, 1)$  is a torus bundle or semi-bundle.

It remains to consider the cases  $M_1, M_2, M_3$ , and  $M_{14}$ . Recall that  $M_1 \cong Wh \cong N(1)$ ,  $M_2 \cong N(-1/2)$ , the exterior of the 2-bridge link with associated rational number  $10/3$ , and  $M_3 \cong N(-4)$ , the exterior of the Whitehead sister link (see [GW] and [MP, Table A.1]).

For  $M_1 \cong N(1)$ , the toroidal slopes are  $-3$  and  $1$  (with respect to the standard slope coordinates for  $N$ , used in [MP]). We must therefore determine the slopes  $\gamma$  such that  $N(1, \gamma)$  is hyperbolic, i.e.  $\gamma \notin \{\infty, -3, -2, -1, 0, 1\}$  (see [MP, Table A.1]),  $N(-3, 1, \gamma)$  and  $N(1, 1, \gamma)$  are toroidal, and one is a torus bundle or semi-bundle. An examination of Tables 2, 3 and 4 of [MP] shows that the only such slopes are (a)  $\gamma = n \in \mathbb{Z}$ ,  $n \neq -1, 1$ , and (b)  $\gamma = -(2n + 1)/(2n + 3)$ ,  $n \in \mathbb{Z}$ ,  $n \neq -2, -1$ . Note that  $N(-3, 1, \gamma)$  is a torus bundle in case (a) and a torus semi-bundle in case (b). Translating the slopes into the standard coordinates for  $Wh$  gives the examples in parts (2) of Theorems 1.6 and 1.7.

For  $M_2 \cong N(-1/2)$  and  $M_3 \cong N(-4)$  we do a similar analysis, the corresponding sets of exceptional slopes being  $\{\infty, -4, -3, -2, -1, 0\}$  and  $\{\infty, -3, -2, -1, -5/2, 0\}$ , respectively, and toroidal slopes  $\{-4, 0\}$  and  $\{-5/2, 0\}$  (see [MP, Table A.1]). We conclude from Tables 2, 3 and 4 of [MP] that no triples  $(M; \alpha, \beta)$  of the required type arise.

Finally we take care of  $M_{14}$ . It follows from the classification in [GW] of the hyperbolic knot manifolds with toroidal fillings at distance 4 that  $M_{14} \cong Y$ , where  $Y$  is the manifold defined by Lee in [L1]. The two toroidal fillings of  $Y$  are  $Y(0) \cong Y(4) \cong Q(2, 2) \cup Wh$ , where  $Q(2, 2)$  is the Seifert manifold with base orbifold  $D^2(2, 2)$ . If  $Q(2, 2) \cup Wh(\gamma)$  were a torus bundle or semi-bundle then  $\gamma$  would be an exceptional slope for  $Wh$ , and therefore would be in  $\{\infty, -4, -3, -2, -1, 0\}$ . But from [MP, Table A.1] (making the appropriate change of slope coordinates) we see that for no such  $\gamma$  is  $Q(2, 2) \cup Wh(\gamma)$  a torus bundle or semi-bundle.

#### 4. INITIAL ASSUMPTIONS AND REDUCTIONS

We assume throughout the paper that  $M$  is a hyperbolic knot manifold. A *slope* on the boundary of  $M$  is a  $\partial M$ -isotopy class of essential simple closed curves. Slopes correspond bijectively with  $\pm$  pairs of primitive elements of  $H_1(\partial M)$  in the obvious way and we shall often represent a slope by a primitive element of  $H_1(\partial M)$ . The *rational longitude* on  $\partial M$  is the unique slope  $\lambda_M$  having the property that it represents a torsion element of  $H_1(M)$ .

To each slope  $\gamma$  on  $\partial M$  we associate the  $\gamma$ -Dehn filling of  $M$ , denoted by  $M(\gamma)$ , obtained by attaching a solid torus  $V$  to  $M$  in such a way that the meridional slope of  $V$  is identified with  $\gamma$ . The resulting manifold is independent of all choices.

Given a closed, essential surface  $S$  in  $M$ , we use  $\mathcal{C}(S)$  to denote the set of slopes  $\delta$  on  $\partial M$  such that  $S$  compresses in  $M(\gamma)$ . A slope  $\eta$  on  $\partial M$  is called a *singular slope* for  $S$  if  $\eta \in \mathcal{C}(S)$  and  $\Delta(\gamma, \eta) \leq 1$  for each  $\gamma \in \mathcal{C}(S)$ . For instance, if  $M(\eta)$  is Seifert fibred with hyperbolic

base orbifold other than a 2-sphere with three cone points or a projective plane with two cone points, then  $\eta$  is a singular slope of some closed, essential surface in  $M$  ([BGZ1, Theorem 1.7]). A theorem of Wu ([Wu1]) shows that if  $S$  is a closed essential surface in  $M$  for which  $\mathcal{C}(S) \neq \emptyset$ , then there is a singular slope for  $S$ .

**Proposition 4.1.** (cf. [BGZ1, Theorem 1.5]) *If  $\eta$  is a singular slope for some closed essential surface  $S$  in  $M$ , then for an arbitrary slope  $\gamma$  we have*

$$\Delta(\gamma, \eta) \leq \begin{cases} 1 & \text{if } M(\gamma) \text{ is either small Seifert or reducible} \\ 1 & \text{if } M(\gamma) \text{ is Seifert fibred and } S \text{ does not separate} \\ 2 & \text{if } M(\gamma) \text{ is toroidal and } \mathcal{C}(S) \text{ is infinite} \\ 3 & \text{if } M(\gamma) \text{ is toroidal and } \mathcal{C}(S) \text{ is finite.} \end{cases}$$

Consequently if  $M(\gamma)$  is not hyperbolic, then  $\Delta(\gamma, \eta) \leq 3$ .  $\diamond$

**Proposition 4.2.** *Suppose that  $F$  is an essential, properly embedded, twice-punctured torus of boundary slope  $\beta$  which caps-off to a compressible torus in  $M(\beta)$ . If  $\gamma$  is a slope on  $\partial M$  such that  $M(\gamma)$  is not hyperbolic, then  $\Delta(\gamma, \beta) \leq 3$ . If  $M(\gamma)$  is a small Seifert manifold, then  $\Delta(\gamma, \beta) \leq 1$ .*

*Proof.* If  $F$  is non-separating the proposition is a special case of [BGZ3, Proposition 3.1]. Assume then that  $F$  is separating. The surface  $F$  splits  $M$  into two components which we denote by  $X^\pm$ , and  $\partial F$  splits  $\partial M$  into two annuli which we denote by  $B^\pm$  so that  $F \cup B^\pm = \partial X^\pm$ . Let  $\widehat{F}$  be the corresponding torus in  $M(\beta)$  obtained by capping off  $\partial F$  with two disjoint meridian disks  $D_1$  and  $D_2$  of the filling solid torus  $V_\beta$ . The disks  $D_1$  and  $D_2$  cut  $V_\beta$  into two components  $H^\pm$  with  $H^\pm$  attached to  $X^\pm$  along  $B^\pm$  as a 2-handle. Let  $\widehat{X}^\pm = X^\pm \cup_{B^\pm} H^\pm$ . If  $\partial X^\epsilon$ ,  $\epsilon \in \{+, -\}$ , is compressible in  $X^\epsilon$ , then by the handle addition lemma ([Ja2, Theorem 2]),  $\widehat{F} = \partial \widehat{X}^\epsilon$  is incompressible in  $\widehat{X}^\epsilon$ . Hence by the assumption of the proposition,  $\partial X^\epsilon$  is incompressible in  $X^\epsilon$  for at least one  $\epsilon$ , say  $\epsilon = +$ . Then  $\partial X^+$  is also incompressible in  $M$ , since  $F$  is (cf. [Ha, §1.2(5), page 15]). Pushing  $\partial X^+$  slightly into the interior of  $X^+$ , we obtain an embedded closed separating incompressible surface  $S$  in  $M$ . Since  $S$  contains an essential simple closed curve which is isotopic to the center circle of the annulus  $B^+ \subset \partial M$ ,  $\beta$  is a singular slope by [CGLS, Theorem 2.4.3]. The proposition now follows from Proposition 4.1.  $\diamond$

Here is a list of assumptions that will hold throughout the paper.

**Assumptions 4.3.**

- (1)  $\alpha$  is a slope on  $\partial M$  such that  $M(\alpha)$  is Seifert fibred.
- (2)  $\beta \neq \alpha$  is a slope on  $\partial M$  of an essential, twice-punctured torus  $F$ .
- (3)  $F$  caps-off to an essential torus in  $M(\beta)$  (cf. Proposition 4.2).
- (4) Neither  $\alpha$  nor  $\beta$  is a singular slope of a closed essential surface in  $M$  (cf. Proposition 4.1).
- (5)  $M(\alpha)$  is an irreducible, atoroidal, small Seifert manifold with base orbifold  $S^2(a, b, c)$  where  $a, b, c \geq 1$  ( cf. [BGZ3, Theorem 1.2 and Proposition 3.3(b)]).
- (6)  $M(\beta)$  is irreducible (cf. [BGZ3, Proposition 3.3(b)]).

Assumption 4.3(5) implies that  $b_1(M)$ , the first Betti number of  $M$ , is at most 2 and if it is 2, then  $M(\alpha)$  fibres over the circle with fibre a horizontal surface.

Here are some additional notations which will be used throughout the paper. For a set  $\Omega$  and a subset  $\sigma \subset \Omega$ ,  $\Omega - \sigma$  denotes the complement of  $\sigma$  in  $\Omega$ . When  $\Omega$  is a manifold and  $\sigma \subset \Omega$  a submanifold,  $\Omega \setminus \sigma$  denotes the manifold which is the metric completion of  $\Omega - \sigma$  with respect to the path metric on  $\Omega - \sigma$ .

## 5. CULLER-SHALEN THEORY

We collect various results on the  $PSL_2(\mathbb{C})$ -character variety of  $M$  which will be used in the paper. See [CGLS], [LM], [BZ2] and [BCSZ2] for the details.

Denote by  $\mathcal{D}$  the abelian subgroup of  $PSL_2(\mathbb{C})$  consisting of diagonal matrices and by  $\mathcal{N}$  the subgroup consisting of those matrices which are either diagonal or have diagonal coefficients 0. Note that  $\mathcal{D}$  has index 2 in  $\mathcal{N}$  and any element in  $\mathcal{N} - \mathcal{D}$  has order 2.

The action of  $SL_2(\mathbb{C})$  on  $\mathbb{C}^2$  descends to one of  $PSL_2(\mathbb{C})$  on  $\mathbb{C}P^1$ . We call a representation  $\rho$  with values in  $PSL_2(\mathbb{C})$  *irreducible* if the associated action on  $\mathbb{C}P^1$  is fixed point free, otherwise we call it *reducible*. We call it *strictly irreducible* if the action has no invariant subset in  $\mathbb{C}P^1$  with fewer than three points. Equivalently,  $\rho$  is strictly irreducible if it is irreducible and is not conjugate to a representation with values in  $\mathcal{N}$ .

Let  $\Gamma$  be a finitely generated group. The set  $R_{PSL_2}(\Gamma)$  of representations of  $\Gamma$  with values in  $PSL_2(\mathbb{C})$  admits the structure of a  $\mathbb{C}$ -affine algebraic set [LM] called the  $PSL_2(\mathbb{C})$ -*representation variety* of  $\Gamma$ . The action of  $PSL_2(\mathbb{C})$  on  $R_{PSL_2}(\Gamma)$  determines an algebro-geometric quotient  $X_{PSL_2}(\Gamma)$  whose coordinate ring is  $\mathbb{C}[R_{PSL_2}(\Gamma)]^{PSL_2(\mathbb{C})}$  and a regular map  $t : R_{PSL_2}(\Gamma) \rightarrow X_{PSL_2}(\Gamma)$  [LM]. This quotient is called the  $PSL_2(\mathbb{C})$ -*character variety* of  $\Gamma$ . For  $\rho \in R_{PSL_2}(\Gamma)$ , we denote  $t(\rho)$  by  $\chi_\rho$  and refer to it as the *character* of  $\rho$ . If  $\chi_{\rho_1} = \chi_{\rho_2}$  and  $\rho_1$  is irreducible, then  $\rho_1$  and  $\rho_2$  are conjugate representations. We can therefore call a character  $\chi_\rho$  reducible, irreducible, or strictly irreducible if  $\rho$  has that property.

When  $\Gamma$  is the fundamental group of a path-connected space  $Y$ , we write  $R_{PSL_2}(Y)$  rather than  $R_{PSL_2}(\pi_1(Y))$ ,  $X_{PSL_2}(Y)$  rather than  $X_{PSL_2}(\pi_1(Y))$ , and refer to them respectively as the  $PSL_2(\mathbb{C})$ -*representation variety* of  $Y$  and  $PSL_2(\mathbb{C})$ -*character variety* of  $Y$ .

We call a curve in  $X_{PSL_2}(\Gamma)$  *non-trivial*, respectively *strictly non-trivial*, if it contains an irreducible character, respectively strictly irreducible character. All but at most finitely many characters on a (strictly) non-trivial curve are (strictly) irreducible.

Each  $\gamma \in \pi_1(M)$  determines an element  $f_\gamma$  of the coordinate ring  $\mathbb{C}[X_{PSL_2}(M)]$  satisfying

$$f_\gamma(\chi_\rho) = (\text{trace}(\rho(\gamma)))^2 - 4$$

where  $\rho \in R_{PSL_2}(M)$ . Each  $\delta \in H_1(\partial M) = \pi_1(\partial M)$  determines an element of  $\pi_1(M)$  well-defined up to conjugation and therefore an element  $f_\delta \in \mathbb{C}[X_{PSL_2}(M)]$ . Similarly each slope  $\delta$



on  $\partial M$  determines an element of  $\pi_1(M)$  well-defined up to conjugation and taking inverse, and so defines  $f_\delta \in \mathbb{C}[X_{PSL_2}(M)]$ .

To each curve  $X_0$  in  $X_{PSL_2}(M)$  we associate a function

$$\|\cdot\|_{X_0} : H_1(\partial M; \mathbb{R}) \rightarrow [0, \infty)$$

characterized by the fact that for each  $\delta \in H_1(\partial M)$  we have  $\|\delta\|_{X_0} = \text{degree}(f_\delta : X_0 \rightarrow \mathbb{C})$ . It was shown in [CGLS] that  $\|\cdot\|_{X_0}$  is a seminorm, which we refer to as the *Culler-Shalen seminorm* of  $X_0$ .

Recall that  $X_0$  admits an affine desingularisation  $X_0^\nu \xrightarrow{\nu} X_0$  where  $\nu$  is surjective and regular. Moreover, the smooth projective model  $\tilde{X}_0$  of  $X_0$  is obtained by adding a finite number of ideal points to  $X_0^\nu$ . Thus  $\tilde{X}_0 = X_0^\nu \cup \mathcal{I}(X_0)$  where  $\mathcal{I}(X_0)$  is the set of ideal points of  $X_0$ . There are natural identifications between the function fields of  $X_0, X_0^\nu$ , and  $\tilde{X}_0$ . Thus to each  $f \in \mathbb{C}(X_0)$  we have corresponding  $f^\nu \in \mathbb{C}(X_0^\nu) = \mathbb{C}(X_0)$  and  $\tilde{f} \in \mathbb{C}(\tilde{X}_0) = \mathbb{C}(X_0)$  where  $f^\nu = f \circ \nu = \tilde{f}|_{X_0^\nu}$ .

For  $x \in \tilde{X}_0$  and  $\gamma \in \pi_1(M)$  we use  $Z_x(\tilde{f}_\gamma)$ , respectively  $\Pi_x(\tilde{f}_\gamma)$ , to denote the multiplicity of  $x$  as a zero, respectively pole, of  $\tilde{f}_\gamma$ . From the definition of  $\|\cdot\|_{X_0}$  we see that for each  $\delta \in H_1(\partial M)$  we have

$$(5.0.1) \quad \|\delta\|_{X_0} = \sum_{x \in \tilde{X}_0} Z_x(\tilde{f}_\delta) = \sum_{x \in \mathcal{I}(X_0)} \Pi_x(\tilde{f}_\delta)$$

For each group  $G$ , an epimorphism  $\varphi : \pi_1(M) \rightarrow G$  determines a closed injective morphism  $\varphi^* : X_{PSL_2}(G) \rightarrow X_{PSL_2}(M)$ ,  $\chi_\rho \mapsto \chi_{\rho \circ \varphi}$ . In particular, we can identify  $X_{PSL_2}(M(\beta))$  with an algebraic subset of  $X_{PSL_2}(M)$ .

Recall that the triple  $(M, \alpha, \beta)$  always satisfies Assumptions 4.3. The purpose of this section is to prepare some results to be applied later to deal with a special case when  $X_{PSL_2(\mathbb{C})}(M(\beta))$  is positive dimensional and contains a nontrivial curve  $X_0$ . Under this extra condition,  $X_0 \subset X_{PSL_2}(M(\beta)) \subset X_{PSL_2}(M)$  yields a Culler-Shalen seminorm for which  $\|\beta\|_{X_0} = 0$  (since  $f_\beta$  is constantly equal to 0 on  $X_0$ ). In fact, if  $\beta^*$  is a dual slope to  $\beta$  (i.e.  $\Delta(\beta, \beta^*) = 1$ ) and we set  $s_{X_0} = \|\beta^*\|_{X_0}$ , then for each slope  $\delta$  on  $\partial M$  we have

$$(5.0.2) \quad \|\delta\|_{X_0} = \Delta(\delta, \beta) s_{X_0}.$$

It follows from the proof of [Bo, Proposition 6.2] that for each  $x \in X_0^\nu$  and slope  $\delta \neq \beta$  we have  $Z_x(\tilde{f}_\delta) \geq Z_x(\tilde{f}_{\beta^*})$ . Set

$$J_{X_0}(\alpha) = \{x \in \tilde{X}_0 : Z_x(\tilde{f}_\alpha) > Z_x(\tilde{f}_\delta) \text{ for some } \delta \in H_1(\partial M) - \{0\}\}$$

Since  $X_0$  is non-trivial, each element of  $X_0$  is the character of a representation which is either irreducible, or has non-abelian image, or has image  $\{\pm I\}$ . (See [Bo, §2].) In the last case, we must have  $b_1(M(\beta)) = 2$  (cf. [Bo, Proposition 2.8]), so  $\beta = \lambda_M$ , where  $\lambda_M$  is the rational longitude of  $M$ . (Note that as remarked right after Assumptions 4.3,  $b_1(M)$  is at most 2.)

It is shown in [BZ2, Lemma 4.1] that the inverse image in  $R_{PSL_2}(M)$  of a non-trivial irreducible curve  $X_0 \subset X_{PSL_2}(M)$  has a unique 4-dimensional component  $R_0$  which is conjugation invariant and maps onto  $X_0$ .

**Lemma 5.1.** *Suppose that Assumptions 4.3 hold and let  $X_0 \subset X_{PSL_2}(M(\beta)) \subset X_{PSL_2}(M)$  be a non-trivial irreducible curve. Fix  $x \in J_{X_0}(\alpha) \cap X_0'$  and fix  $\rho \in R_0$  satisfying  $\nu(x) = \chi_\rho$ .*

(1)  $\rho$  factors through  $\pi_1(M(\alpha)) \rightarrow \pi_1(S^2(a, b, c)) = \Delta(a, b, c)$  and can be chosen to be either irreducible or have non-abelian image.

(2)  $\chi_\rho$  is a simple point of  $X_{PSL_2}(M)$ .

(3) If  $\nu(x)$  is irreducible and  $X_0$  is strictly non-trivial, then

$$Z_x(\tilde{f}_\alpha) = \begin{cases} 1 & \text{if the image of } \rho \text{ is a dihedral group of order 6 or more} \\ 2 & \text{if } \rho \text{ is strictly irreducible} \end{cases}$$

*Proof.* It follows from the discussion preceding the lemma, the condition  $x \in J_{X_0}(\alpha) \cap X_0'$  implies  $Z_x(\tilde{f}_\alpha) > Z_x(\tilde{f}_{\beta^*})$ . Thus it follows from part (1)(b) of [Bo, Proposition 6.2] that  $\rho(\pi_1(\partial M))$  is a nontrivial finite cyclic group. In particular  $\nu(x)$  is not the character of the trivial representation. It also follows from [CGLS, Proposition 1.5.4] that  $\rho(\alpha) = \pm I$ , and so  $\rho$  induces a homomorphism  $\pi_1(M(\alpha)) \rightarrow PSL_2(\mathbb{C})$ . As noted just before the statement of the lemma, we can choose  $\rho$  to be irreducible or have non-abelian image. In either case, it further factors through  $\pi_1(S^2(a, b, c)) = \Delta(a, b, c)$  by Lemma 3.1 of [BeBo], thus proving (1). It then follows from [BeBo, Proposition and Theorem 1.1] that  $\chi_\rho$  is a simple point of  $X_{PSL_2}(M)$ , so (2) holds. Finally, (3) is a consequence of the method of the proof of [BZ2, Lemma 6.1] combined with (2), which completes the proof.  $\diamond$

Set

$$\mathcal{N}_{X_0}(\alpha) = \{x \in J_{X_0}(\alpha) \cap X_0' \mid \nu(x) = \chi_\rho \text{ where } \rho \text{ is irreducible and takes values in } \mathcal{N}\}$$

**Proposition 5.2.** *Suppose that Assumptions 4.3 hold and let  $X_0$  be a curve in  $X_{PSL_2}(M(\beta)) \subset X_{PSL_2}(M)$  and  $\beta^* \in H_1(\partial M)$  be a dual class to  $\beta$ .*

(1) *If  $\tilde{f}_{\beta^*}$  has poles at each ideal point of  $\tilde{X}_0$  and  $n > 1$  divides  $\Delta(\alpha, \beta)$ , then there is a point  $x \in J_{X_0}(\alpha) \cap X_0'$  such that  $\rho(\pi_1(\partial M)) = \mathbb{Z}/n$  for any  $\rho$  with  $\nu(x) = \chi_\rho$ .*

(2) *If  $X_0$  is strictly non-trivial and  $s_{X_0} \neq 0$ , then*

$$\Delta(\alpha, \beta) = 1 + \frac{1}{s_{X_0}} (2|J_{X_0}(\alpha)| - |\mathcal{N}_{X_0}(\alpha)|)$$

*as long as  $J_{X_0}(\alpha) \subset X_0'$ ,  $\nu(x)$  is irreducible for each  $x \in J_{X_0}(\alpha)$  and no element of  $\mathcal{N}_{X_0}(\alpha)$  corresponds to the character of a representation with image a dihedral group of order 4.*

*Proof.* Part (1) follows from part (2) of [Bo, Proposition 6.2].

Under the conditions of part (2) of this proposition, note that a point  $x$  of  $\tilde{X}_0$  belongs to  $J_{X_0}(\alpha)$  if and only if  $Z_x(\tilde{f}_\alpha) > Z_x(\tilde{f}_{\beta^*})$ . Thus

$$\Delta(\alpha, \beta)s_{X_0} = \|\alpha\|_{X_0} = \sum_{x \in \tilde{X}_0} Z_x(\tilde{f}_\alpha) = \sum_{x \in \tilde{X}_0} Z_x(\tilde{f}_{\beta^*}) + \sum_{x \in J_{X_0}(\alpha)} Z_x(\tilde{f}_\alpha) = s_{X_0} + \sum_{x \in J_{X_0}(\alpha)} Z_x(\tilde{f}_\alpha).$$

The formula in part (2) now follows from Lemma 5.1(3).  $\diamond$

## 6. BENDING CHARACTERS OF TRIANGLE GROUP AMALGAMS

**6.1. Curves of characters of free products of cyclic groups.** In this section we construct curves in the character varieties of certain amalgams of triangle groups to be used to prove the cases of Theorem 1.2 examined in §7, §10.2, §18, and §19.

Fix integers  $q \geq p \geq 2$  and write  $\mathbb{Z}/p * \mathbb{Z}/q = \langle a, b : a^p = b^q = 1 \rangle$ . It was shown in Example 3.2 of [BZ2] that  $X_{PSL_2}(\mathbb{Z}/p * \mathbb{Z}/q)$  is a disjoint union of a finite number of isolated points and  $\lfloor \frac{p}{2} \rfloor \lfloor \frac{q}{2} \rfloor$  non-trivial curves, each isomorphic to a complex line. Explicit parametrisations of these curves can be given as follows. For integers  $j, k$  with  $1 \leq j \leq \lfloor \frac{p}{2} \rfloor$  and  $1 \leq k \leq \lfloor \frac{q}{2} \rfloor$ , set

$$\lambda = e^{\pi i j / p}, \mu = e^{\pi i k / q}, \tau = \mu + \mu^{-1}.$$

For  $z \in \mathbb{C}$  define  $\rho_z \in R_{PSL_2}(\mathbb{Z}/p * \mathbb{Z}/q)$  by

$$\rho_z(a) = \pm \begin{pmatrix} \lambda & 0 \\ 0 & \lambda^{-1} \end{pmatrix}, \rho_z(b) = \pm \begin{pmatrix} z & 1 \\ z(\tau - z) - 1 & \tau - z \end{pmatrix}.$$

The characters of the representations  $\rho_z$  parameterize a curve  $X(j, k) \subset X_{PSL_2}(\mathbb{Z}/p * \mathbb{Z}/q)$ . Moreover, it is shown in [BZ2, Example 3.2] that the holomorphic map

$$\Psi_{(j,k)} : \mathbb{C} \rightarrow X(j, k), z \mapsto \chi_{\rho_z},$$

is bijective if  $j < \frac{p}{2}$  and  $k < \frac{q}{2}$ , and a 2-1 branched cover otherwise. Since  $(\text{trace}(\rho_z(ab)))^2 - 4 = ((\lambda - \lambda^{-1})z + \lambda^{-1}\tau)^2 - 4$ , the map

$$f_{ab} : X(j, k) \rightarrow \mathbb{C}, \chi_{\rho_z} \mapsto (\text{trace}(\rho_z(ab)))^2 - 4$$

has degree 1 if  $j = \frac{p}{2}$  or  $k = \frac{q}{2}$ , and 2 otherwise.

**Lemma 6.1.** *Fix a positive integer  $d > 2$  and an element  $A$  of order  $d$  in  $PSL_2(\mathbb{C})$ .*

(1) *If  $1 \leq j < \frac{p}{2}$  and  $1 \leq k < \frac{q}{2}$ , then there is an irreducible character  $\chi_\rho \in X(j, k)$  such that  $\rho(ab) = A$ .*

(2) *If  $j = \frac{p}{2}$  or  $k = \frac{q}{2}$ , then there is an irreducible character  $\chi_\rho \in X(j, k)$  such that  $\rho(ab) = A$  for all but at most one curve  $X(j, k) \subset X_{PSL_2}(\mathbb{Z}/p * \mathbb{Z}/q)$ .*

(3)(a) *If  $(p, q, d) \neq (2, 3, 6)$ , there is an irreducible representation  $\rho : \mathbb{Z}/p * \mathbb{Z}/q \rightarrow PSL_2(\mathbb{C})$  such that  $\rho(ab) = A$ .*

(b) *If  $(p, q, d) \neq (2, 3, 6), (2, 6, 3), (2, 4, 4)$ , there is an irreducible representation  $\rho : \mathbb{Z}/p * \mathbb{Z}/q \rightarrow PSL_2(\mathbb{C})$  such that  $\rho(a)$  has order  $p$ ,  $\rho(b)$  has order  $q$ , and  $\rho(ab) = A$ .*

*Proof.* Fix a curve  $X(j, k) \subset X_{PSL_2}(\mathbb{Z}/p * \mathbb{Z}/q)$  and consider the parametrisation  $\Psi_{(j,k)} : \mathbb{C} \rightarrow X(j, k), z \mapsto \chi_{\rho_z}$  described above. If  $\omega = (\text{trace}(A))^2 - 4$ , then  $\rho_z(ab)$  is conjugate to  $A$  if and only if  $f_{ab}(\chi_{\rho_z}) = \omega$ . Hence we must show that under the hypotheses of the lemma, we can find a  $z \in \mathbb{C}$  such that  $\rho_z$  is irreducible and  $f_{ab}(\chi_{\rho_z}) = \omega$ . It is clear that  $\rho_z$  is reducible if and only if  $z^2 - \tau z + 1 = 0$ , or equivalently,  $z = \mu, \mu^{-1}$ .

Let  $g_\omega$  be the polynomial  $g_\omega(z) = f_{ab}(\chi_{\rho_z}) - \omega = ((\lambda - \lambda^{-1})z + \lambda^{-1}\tau)^2 - (\omega + 4)$ . By construction,  $\omega \in (-4, 0)$ , and the reader will verify that this implies that  $g$  has simple roots. Thus if there is no irreducible character  $\chi_\rho \in X(j, k)$  such that  $\rho(ab) = A$ , then the two roots of  $g_\omega$  are  $\mu$  and  $\mu^{-1}$ . On the other hand, if  $z$  is a root of  $g_\omega$ , then  $\rho_z(ab)$  is conjugate to  $A$  in  $PSL_2(\mathbb{C})$ , so the eigenvalues of  $\rho_z(ab)$  coincide with those of  $A$ , at least up to sign. Hence the eigenvalues of  $\rho_\mu(ab)$  and  $\rho_{\mu^{-1}}(ab)$  coincide up to sign. It follows that  $\lambda\mu^{-1} \in \{\pm\lambda\mu, \pm\lambda^{-1}\mu^{-1}\}$ . But this implies that either  $\lambda^2 = -1$  or  $\mu^2 = -1$ , i.e.  $j = p/2$  or  $k = q/2$ . Part (1) of the lemma thus holds.

Now assume that  $j = \frac{p}{2}$ , so  $\lambda = i$ . If there is no irreducible character  $\chi_\rho \in X(\frac{p}{2}, k)$  such that  $\rho(ab) = A$ , then by the argument in the preceding paragraph the eigenvalues of  $A$  are  $\pm i\mu_k, \pm i\mu_k^{-1}$ . (We write  $\mu_k$  here to underline the dependence of  $\mu$  on  $k$ .) Suppose as well that there is no irreducible character  $\chi_{\rho'} \in X(\frac{p}{2}, k')$  such that  $\rho'(ab) = A$ , for some  $1 \leq k' \leq \lfloor \frac{q}{2} \rfloor$ . Then the eigenvalues of  $A$  are  $\pm i\mu_{k'}, \pm i\mu_{k'}^{-1}$ . Thus  $\mu_{k'} \in \{\pm\mu_k, \pm\mu_k^{-1}\}$ . Hence  $e^{2\pi i(k \pm k')/q} = 1$ , or equivalently,  $k' \equiv \pm k \pmod{q}$ . Our constraints on  $k$  and  $k'$  then imply that  $k' = k$ .

The case that  $k = \frac{q}{2}$  can be handled similarly, which completes the proof of (2).

It follows from (1) and (2) that if there is no irreducible representation  $\rho : \mathbb{Z}/p * \mathbb{Z}/q \rightarrow PSL_2(\mathbb{C})$  such that  $\rho(ab) = A$ , then  $p = 2$  and  $\lfloor \frac{q}{2} \rfloor = 1$ , so  $q = 2$  or  $3$ . The case  $q = 2$  is easily ruled out using elementary properties of the dihedral group  $\Delta(2, 2, d)$ . Suppose then that  $q = 3$ . The proofs of (1) and (2) show that some eigenvalue of  $A$  is conjugate to  $\pm\lambda\mu = \pm ie^{\pm\pi i/3}$ . But then  $d = 6$ , so (3)(a) holds.

To prove part (3)(b), suppose that there is no irreducible representation  $\rho : \mathbb{Z}/p * \mathbb{Z}/q \rightarrow PSL_2(\mathbb{C})$  such that  $\rho(a)$  has order  $p$ ,  $\rho(b)$  has order  $q$ , and  $\rho(ab) = A$ . By (1) and (2), we see that  $p = 2$ . Further, (2) implies that the value of Euler's totient function at  $q$  is at most 2, so  $q$  is either 2, 3, 4, or 6. We have already seen that the case that  $q = 2$  can be ruled out and that  $q = 3$  implies that  $(p, q, d) = (2, 3, 6)$ . If  $q = 4$  or  $6$ , the argument of the previous paragraph shows that  $(p, q, d) = (2, 4, 4)$  or  $(2, 6, 3)$  or  $(2, 6, 6)$ . Since  $(2, 6, 6)$  is a hyperbolic triple, there is a discrete faithful irreducible representation  $\rho : \Delta(2, 6, 6) \rightarrow PSL_2(\mathbb{C})$ , and since there is a unique conjugacy class of elements of order 6 in  $PSL_2(\mathbb{C})$ , we can assume that  $\rho(ab) = A$ , a contradiction. This completes the proof.  $\diamond$

**6.2. Amalgamated products.** Fix positive integers  $p_+ \leq q_+, p_- \leq q_-$  and  $d$ , each at least 2, and consider the triangle groups

$$\Delta(p_+, q_+, d) = \langle a_+, b_+ : a_+^{p_+} = b_+^{q_+} = (a_+ b_+)^d = 1 \rangle$$

$$\Delta(p_-, q_-, d) = \langle a_-, b_- : a_-^{p_-} = b_-^{q_-} = (a_- b_-)^d = 1 \rangle$$

For each  $\epsilon \in \{\pm\}$ ,  $\mathbb{Z}/d \cong \langle a_\epsilon b_\epsilon \rangle \leq \Delta(p_\epsilon, q_\epsilon, d)$ . Let  $\psi : \langle a_+ b_+ \rangle \rightarrow \langle a_- b_- \rangle$  be an isomorphism. Then

$$\psi(a_+ b_+) = (a_- b_-)^s$$

where  $1 \leq s < d$  and  $\gcd(s, d) = 1$ . We consider the amalgamated free product

$$\Delta(p_+, q_+, d) *_{\psi} \Delta(p_-, q_-, d)$$

**Lemma 6.2.** *There is a homomorphism  $\rho : \Delta(p_+, q_+, d) *_{\psi} \Delta(p_-, q_-, d) \rightarrow PSL_2(\mathbb{C})$  satisfying:*

- (1) *The restriction  $\rho_{\epsilon}$  of  $\rho$  to  $\Delta(p_{\epsilon}, q_{\epsilon}, d)$  is irreducible for both values of  $\epsilon$ .*
- (2) *If  $\rho_+$  is not faithful then either  $(p_+, q_+, d)$  is a Euclidean triple or  $(p_-, q_-, d) = (2, 3, 6)$ . Further,*
  - (a) *if  $(p_+, q_+, d)$  is a Euclidean triple, then  $\rho_+$  has image isomorphic to*
    - $\Delta(2, 3, 3)$  *when  $(p_+, q_+, d)$  is a permutation of  $(2, 3, 6)$  or  $(3, 3, 3)$ ;*
    - $\Delta(2, 2, 4)$  *when  $(p_+, q_+, d)$  is a permutation of  $(2, 4, 4)$ ;*
  - (b) *if  $(p_+, q_+, d)$  is a spherical or hyperbolic triple and  $(p_-, q_-, d) = (2, 3, 6)$ ,  $\rho_+$  can be taken to factor through a representation of  $\Delta(p_+, q_+, 3)$  which is faithful if  $(p_+, q_+, 3)$  is spherical or hyperbolic.*
- (3)  $\rho_+(\langle a_+ b_+ \rangle) \cong \begin{cases} \mathbb{Z}/d & \text{if } (p_{\epsilon}, q_{\epsilon}, d) \neq (2, 3, 6) \text{ for both } \epsilon \\ \mathbb{Z}/3 & \text{if } (p_{\epsilon}, q_{\epsilon}, d) = (2, 3, 6) \text{ for some } \epsilon \end{cases}$
- (4)(a) *If  $d > 2$ , then  $\rho_-(a_-)$  has order  $p_-$  and either  $\rho_-(b_-)$  has order  $q_-$  or*
  - $(p_+, q_+, d) = (2, 3, 6)$ ,  $(p_-, q_-, d) = (2, 6, 6)$  *and  $\rho_-(b_-)$  has order 3,*
  - $(p_+, q_+, d) = (3, 3, 3)$ ,  $(p_-, q_-, d) = (2, 6, 3)$  *and  $\rho_-(b_-)$  has order 3,*
  - $(p_-, q_-, d) = (2, 4, 4)$  *and  $\rho_-(b_-)$  has order 2.*
- (b) *If  $d = 2$ ,  $\rho_-$  is a discrete faithful representation when  $(p_-, q_-, 2)$  is a spherical or hyperbolic triple, or an epimorphism  $\Delta(3, 6, 2) \rightarrow \Delta(3, 3, 2)$ , or an epimorphism  $\Delta(4, 4, 2) \rightarrow \Delta(4, 2, 2)$ .*
- (5) *If  $\rho$  is conjugate to a representation with values in  $\mathcal{N}$ , then  $(p_{\epsilon}, q_{\epsilon}, d)$  is a permutation of either  $(2, 4, 4)$  or some  $(2, 2, n)$  for both values of  $\epsilon$ .*

*Proof.* We construct  $\rho$  by piecing together representations  $\rho_+ : \Delta(p_+, q_+, d) \rightarrow PSL_2(\mathbb{C})$  and  $\rho_- : \Delta(p_-, q_-, d) \rightarrow PSL_2(\mathbb{C})$  which agree on  $\langle a_+ b_+ \rangle \equiv_{\psi} \langle a_- b_- \rangle$ .

First suppose that  $(p_+, q_+, d)$  is spherical or hyperbolic. If

- $(p_-, q_-, d) \neq (2, 3, 6)$ , we choose  $\rho_+$  to be discrete and faithful;
- $(p_-, q_-, d) = (2, 3, 6)$  and  $(p_+, q_+, 3)$  is spherical or hyperbolic, we take  $\rho_+$  to be a discrete, faithful representation of  $\Delta(p_+, q_+, 3)$ ;
- $(p_-, q_-, d) = (2, 3, 6)$  and  $(p_+, q_+, 3)$  is Euclidean, then  $(p_+, q_+, 3) = (2, 6, 3)$  or  $(3, 3, 3)$ . In either case we take  $\rho_+$  to be an epimorphism  $\Delta(p_+, q_+, 3) \rightarrow \Delta(2, 3, 3)$ .

There are several cases to consider when  $(p_+, q_+, d)$  is a Euclidean triple:

- if  $(p_+, q_+, d) = (3, 3, 3)$ , we take  $\rho_+$  to be an epimorphism  $\Delta(3, 3, 3) \rightarrow \Delta(2, 3, 3) \subset SO(3) \subset PSL_2(\mathbb{C})$ . Note that each element of order 3 in  $\Delta(3, 3, 3)$  is sent to an element of order 3 in  $\Delta(2, 3, 3)$ .

- if  $(p_+, q_+, d)$  is a permutation of  $(2, 4, 4)$ , we take  $\rho_+$  to be an epimorphism of  $\Delta(p_+, q_+, d)$  onto  $\Delta(2, 2, 4) \subset SO(3) \subset PSL_2(\mathbb{C})$  which send  $a_+b_+$  to an element of order  $d$ .
- if  $(p_+, q_+, d)$  is a permutation of  $(2, 3, 6)$ , we take  $\rho_+$  to be an epimorphism of  $\Delta(p_+, q_+, d)$  onto  $\Delta(2, 3, 3)$

The reader will verify that assertion (3) holds with these choices.

Next we construct  $\rho_-$ .

In the case that  $\rho_+(\langle a_+b_+ \rangle) \cong \mathbb{Z}/d$  and  $d > 2$ , neither  $(p_+, q_+, d)$  nor  $(p_-, q_-, d)$  is  $(2, 3, 6)$ . Lemma 6.1(3) implies that if  $(p_-, q_-, d) \neq (2, 6, 3), (2, 4, 4)$ , we can find an irreducible representation  $\rho_- : \Delta(p_-, q_-, d) \rightarrow PSL_2(\mathbb{C})$  such that  $\rho_-(a_-)$  has order  $p_-$ ,  $\rho_-(b_-)$  has order  $q_-$ , and  $\rho_-(a_-b_-) = \rho_+(a_+b_+)^m$  where  $m$  is an integer satisfying  $sm + dl = 1$  for some integer  $l$ . So we have  $\rho_-(a_-b_-)^s = \rho_+(a_+b_+)$ . This identity shows that  $\rho_+$  pieces together with  $\rho_-$  to form a homomorphism  $\rho$  satisfying assertions (1) through (4). If  $(p_-, q_-, d) = (2, 6, 3)$  or  $(2, 4, 4)$ , we take  $\rho_-$  to be an epimorphism  $\Delta(2, 6, 3) \rightarrow \Delta(2, 3, 3)$  or an epimorphism  $\Delta(2, 4, 4) \rightarrow \Delta(2, 2, 4)$ . A conjugate of  $\rho_-$  will then piece together with  $\rho_+$  since there is a unique conjugacy class of elements of order 3 in  $PSL_2(\mathbb{C})$  and a unique conjugacy class of elements of order 4.

In the case that  $\rho_+(\langle a_+b_+ \rangle) \cong \mathbb{Z}/2$ , we choose  $\rho_-$  to be a discrete faithful representation when  $(p_-, q_-, 2)$  is a spherical or hyperbolic triple. Otherwise we choose  $\rho_-$  to be an epimorphism  $\Delta(3, 6, 2) \rightarrow \Delta(3, 3, 2)$  or an epimorphism  $\Delta(4, 4, 2) \rightarrow \Delta(2, 4, 2)$ . Since there is a unique conjugacy class of elements of order 2 in  $PSL_2(\mathbb{C})$ , a conjugate of  $\rho_-$  will piece together with  $\rho_+$  to produce a homomorphism  $\rho$  satisfying assertions (1) through (4).

If  $\rho_+(\langle a_+b_+ \rangle) \not\cong \mathbb{Z}/d$ , then  $\rho_+(\langle a_+b_+ \rangle) \cong \mathbb{Z}/3$  and some  $(p_\epsilon, q_\epsilon, d)$  is  $(2, 3, 6)$ . If

- $(p_+, q_+, d) = (2, 3, 6)$  and  $(p_-, q_-, 3)$  is spherical or hyperbolic, we take  $\rho_-$  to be the composition of the obvious epimorphism  $\Delta(p_-, q_-, 6) \rightarrow \Delta(p_-, q_-, 3)$  with a faithful representation  $\Delta(p_-, q_-, 3) \rightarrow PSL_2(\mathbb{C})$ ;
- if  $(p_+, q_+, d) = (2, 3, 6)$  and  $(p_-, q_-, 3)$  is Euclidean, then  $(p_-, q_-, 3) = (2, 6, 3)$  or  $(3, 3, 3)$  and we take  $\rho_-$  to be the composition of the quotient homomorphism  $\Delta(p_-, q_-, 6) \rightarrow \Delta(p_-, q_-, 3)$  with an epimorphism  $\Delta(p_-, q_-, 3) \rightarrow \Delta(2, 3, 3)$ ;
- $(p_+, q_+, d) \neq (2, 3, 6)$ , then  $(p_-, q_-, d) = (2, 3, 6)$  and we take  $\rho_-$  to be an epimorphism  $\Delta(2, 3, 6) \rightarrow \Delta(2, 3, 3)$ .

As above, a conjugate of  $\rho_-$  pieces together with  $\rho_+$  to yield a homomorphism satisfying assertions (1) through (4).

To complete the proof, we verify that assertion (5) holds.

If  $(p_\epsilon, q_\epsilon, d)$  is a permutation of  $(2, 3, 6)$  for some  $\epsilon$ , then the image of  $\rho_\epsilon$  is  $\Delta(2, 3, 3)$ , which does not conjugate into  $\mathcal{N}$ .

Suppose that  $(p_\epsilon, q_\epsilon, d)$  is not a permutation of  $(2, 3, 6)$  for either choice of  $\epsilon$ . Then  $\rho_+(\langle a_+b_+ \rangle) \cong \mathbb{Z}/d$  and the reader will verify that the image of  $\rho_+$  conjugates into  $\mathcal{N}$  if and only if  $(p_+, q_+, d)$  is a permutation of  $(2, 4, 4)$  or some  $(2, 2, n)$ .

Suppose that  $(p_-, q_-, d)$  is not a permutation of  $(2, 4, 4)$  and  $d > 2$ . Then (3) and (4) show that  $\rho_-(a_-)$  has order  $p_-$ ,  $\rho_-(b_-)$  has order  $q_-$ , and  $\rho_-(a_-b_-)$  has order  $d$ . Then as  $\Delta(p_-, q_-, d)$  is generated by any two of  $a_-, b_-, a_-b_-$ , the image of  $\rho_-$  is conjugate into  $\mathcal{N}$  if and only if two  $p_-, q_-, d$  are 2. If  $(p_-, q_-, 2)$  is not  $(4, 4, 2)$  or  $(2, n, 2)$ , then our choice of  $\rho_-$  guarantees that its image cannot be conjugate into  $\mathcal{N}$ , which completes the proof.  $\diamond$

Fix a homomorphism  $\rho : \Delta(p_+, q_+, d) *_{\psi} \Delta(p_-, q_-, d) \rightarrow PSL_2(\mathbb{C})$  and denote by  $\rho_{\epsilon}$  the restriction of  $\rho$  to  $\Delta(p_{\epsilon}, q_{\epsilon}, d)$ . Let  $Z(\rho(\langle a_+b_+ \rangle))$  denote the centraliser of  $\rho(\langle a_+b_+ \rangle)$  in  $PSL_2(\mathbb{C})$  and  $Z^0(\rho(\langle a_+b_+ \rangle))$  its component of the identity. For each  $S \in Z(\rho_+(\langle a_+b_+ \rangle))$ , define  $\rho_S : \Delta(p_+, q_+, d) *_{\psi} \Delta(p_-, q_-, d) \rightarrow PSL_2(\mathbb{C})$  to be the homomorphism determined by the push-out diagram

$$\begin{array}{ccccc}
 & & \Delta(p_+, q_+, d) & & \\
 & \nearrow & & \searrow^{\rho_+} & \\
 \langle a_+b_+ \rangle & & & & PSL_2(\mathbb{C}) \\
 & \searrow & & \nearrow_{S\rho_-S^{-1}} & \\
 & & \Delta(p_-, q_-, d) & & 
 \end{array}$$

We say that the character  $\chi_{\rho_S}$  is obtained by *bending*  $\chi_{\rho}$  by  $S$ . The *bending function* of  $\rho$  is the map

$$\beta_{\rho} : Z_{PSL_2}^0(\rho(\langle a_+b_+ \rangle)) \rightarrow X_{PSL_2}(\Delta(p_+, q_+, d) *_{\psi} \Delta(p_-, q_-, d)), \quad S \mapsto \chi_{\rho_S}.$$

It is shown in [BoiBo, Lemma C.1] that  $\beta_{\rho}$  is constant if and only if one of the following two conditions holds:

- $\rho_+(\langle a_+b_+ \rangle) = \{\pm I\}$  and either  $\rho_+(\Delta(p_+, q_+, d)) = \{\pm I\}$  or  $\rho_-(\Delta(p_-, q_-, d)) = \{\pm I\}$ ;
- $\rho_+(\langle a_+b_+ \rangle) \neq \{\pm I\}$  and either  $\rho_+(\Delta(p_+, q_+, d))$  is abelian and reducible, or  $\rho_-(\Delta(p_-, q_-, d))$  is abelian and reducible, or  $\rho$  is reducible.

In particular, if  $\rho$  is irreducible and  $\beta_{\rho}$  is constant, then  $\rho_{\epsilon}(\Delta(p_{\epsilon}, q_{\epsilon}, d))$  is abelian and reducible for some  $\epsilon$ .

We say that  $\rho$  can be *bent non-trivially* if  $\beta_{\rho}$  is non-constant. In this case, the image of  $\beta_{\rho}$  is contained in a curve in  $X_{PSL_2}(\Delta(p_+, q_+, d) *_{\psi} \Delta(p_-, q_-, d))$ .

**Lemma 6.3.** *Let  $\rho : \Delta(p_+, q_+, d) *_{\psi} \Delta(p_-, q_-, d) \rightarrow PSL_2(\mathbb{C})$  be an irreducible homomorphism as constructed in Lemma 6.2. Then*

- (1)  $\rho$  can be bent non-trivially to produce a non-trivial curve  $Y_0 \subset X_{PSL_2}(\Delta(p_+, q_+, d) *_{\psi} \Delta(p_-, q_-, d))$ .
- (2)  $Y_0$  is strictly non-trivial if and only if  $(p_{\epsilon}, q_{\epsilon}, d) \notin \{(2, 2, d), (2, 4, 4)\}$  for some  $\epsilon$ .
- (3)  $Y_0$  has exactly two ideal points unless  $p_{\epsilon} = q_{\epsilon} = d = 2$  for some  $\epsilon$ , in which case it has one. Further, for each integer  $k$ , the map  $\tilde{f}_{c_+(a_+b_+)^k c_-}$  has a pole at each ideal point of  $Y_0$  where  $c_{\pm} \in \{a_{\pm}, a_{\pm}^{-1}, b_{\pm}, b_{\pm}^{-1}\}$ .

*Proof.* By construction,  $\rho_\epsilon = \rho|\Delta(p_\epsilon, q_\epsilon, d)$  is irreducible for both  $\epsilon$  and so it can be bent non-trivially to produce a curve  $Y_0$  in  $X_{PSL_2}(\Delta(p_+, q_+, d) *_\psi \Delta(p_-, q_-, d))$  determined by bending  $\rho$ .

If  $Y_0$  is *not* strictly non-trivial, it is a curve of characters of representations with values in  $\mathcal{N}$ . Then Lemma 6.2 implies that for each  $\epsilon$ ,  $(p_\epsilon, q_\epsilon, d)$  is a permutation of either  $(2, 4, 4)$  or a triple of the form  $(2, 2, n)$ . Without loss of generality, we can assume that the images of both  $\rho_+$  and  $\rho_-$  are contained in  $\mathcal{N}$ .

If, for some  $\epsilon$ , we have  $(p_\epsilon, q_\epsilon, d) = (2, n, 2)$  for  $n > 2$  or  $(4, 4, 2)$ , then  $\rho_+(a_+b_+) \in \mathcal{N} - \mathcal{D}$ . After conjugating by an element of  $\mathcal{D}$ , we can assume that  $\langle \rho_+(a_+b_+) \rangle = \{\pm I, \pm \begin{pmatrix} 0 & 1 \\ -1 & 0 \end{pmatrix}\}$ . Then  $Z^0(\rho(\langle a_+b_+ \rangle)) = \{\pm \begin{pmatrix} x & y \\ -y & x \end{pmatrix} \mid x^2 + y^2 = 1\}$ . Let  $\rho_{(x,y)}$  denote the representation obtained by piecing together  $\rho_+$  and  $\begin{pmatrix} x & y \\ -y & x \end{pmatrix} \rho_- \begin{pmatrix} x & y \\ -y & x \end{pmatrix}^{-1}$ . Since  $(p_\epsilon, q_\epsilon) \neq (2, 2)$ , the only conjugate of  $\rho_{(x,y)}$  which takes values in  $\mathcal{N}$  is  $\rho_{(x,y)}$  itself when  $\epsilon = +$ , and  $\begin{pmatrix} x & y \\ -y & x \end{pmatrix}^{-1} \rho_{(x,y)} \begin{pmatrix} x & y \\ -y & x \end{pmatrix}$  otherwise. In either case, the fact that  $\begin{pmatrix} x & y \\ -y & x \end{pmatrix}$  conjugates an irreducible subgroup of  $\mathcal{N}$  into  $\mathcal{N}$  implies that  $\pm \begin{pmatrix} x & y \\ -y & x \end{pmatrix} \in \mathcal{N}$ . Thus  $x = 0$  or  $y = 0$ . It follows that for  $xy \neq 0$ ,  $\rho_{(x,y)}$  does not conjugate into  $\mathcal{N}$ , contrary to our assumptions. Thus  $(p_\epsilon, q_\epsilon, d) \in \{(2, 2, d), (2, 4, 4)\}$  for both  $\epsilon$ . This proves the forward implication of (2).

For the reverse implication, suppose that  $(p_+, q_+, d)$  and  $(p_-, q_-, d)$  are of the form  $(2, 2, d)$  or  $(2, 4, 4)$ . As a first case, suppose that  $(p_\epsilon, q_\epsilon, d)$  is either  $(2, 2, d)$  where  $d > 2$  or  $(2, 4, 4)$  for some  $\epsilon$ . Lemma 6.2 then implies that the image of  $\rho_\epsilon$  is isomorphic to  $\Delta(2, 2, d)$  for both  $\epsilon$ , and we can suppose it is contained in  $\mathcal{N}$ . As  $d > 2$ ,  $\rho_+(a_+b_+) \in \mathcal{D}$ . Hence  $Z^0(\rho(\langle a_+b_+ \rangle)) = \mathcal{D}$  and it is then easy to see that the image of  $\rho_S$  is contained in  $\mathcal{N}$  for all  $S \in \mathcal{D}$ . Hence  $Y_0$  contains no characters of strictly irreducible representations.

Suppose next that  $(p_\epsilon, q_\epsilon, d) = (2, 2, 2)$  for both  $\epsilon$ . Then we can conjugate  $\rho$  so that its image lies in  $\mathcal{N}$  and  $\rho_+(a_+b_+) \in \mathcal{D}$ . Hence, again we have that  $Y_0$  contains no characters of strictly irreducible representations, which completes the proof of (2).

Finally we consider assertion (3) for the case that  $c_+ = a_+$  and  $c_- = a_-$ . The other cases are treated similarly.

Without loss of generality we suppose that  $\rho_+(a_+b_+) \in \mathcal{D}$  and therefore  $Z^0(\rho(\langle a_+b_+ \rangle)) = \mathcal{D}$ . There is a morphism

$$g : \mathbb{C}^* \rightarrow Y_0, t \mapsto \chi_{\rho_t}$$

where  $\rho_{t-} = \begin{pmatrix} t & 0 \\ 0 & t^{-1} \end{pmatrix} \rho_- \begin{pmatrix} t^{-1} & 0 \\ 0 & t \end{pmatrix}$ . Then  $\rho_t(a_+(a_+b_+)^k a_-) = \rho_+(a_+) \rho_+(a_+b_+)^k \rho_{t-}(a_-)$ . By construction,  $\rho_+$  and  $\rho_-$  are irreducible and  $\rho_+(a_+b_+)$  is diagonal. Thus we can write

$$\rho_+(a_+) = \pm \begin{pmatrix} a & b \\ c & d \end{pmatrix} \quad \rho_+(a_+b_+) = \pm \begin{pmatrix} s & 0 \\ 0 & s^{-1} \end{pmatrix} \quad \rho_-(a_-) = \pm \begin{pmatrix} x & y \\ z & w \end{pmatrix}$$



where  $bc \neq 0, yz \neq 0$  and  $s \neq 0$ . Then  $\rho_+(a_+(a_+b_+)^k) = \pm \begin{pmatrix} a_0 & b_0 \\ c_0 & d_0 \end{pmatrix}$  where  $b_0c_0 \neq 0$  and  $\rho_t(a_-) = \pm \begin{pmatrix} x & t^2y \\ t^{-2}z & w \end{pmatrix}$  so that

$$\rho_t(a_+(a_+b_+)^k a_-) = \pm \begin{pmatrix} a_0x + t^{-2}b_0z & * \\ * & d_0w + t^2c_0y \end{pmatrix}$$

The trace of  $\rho_t(a_+(a_+b_+)^k a_-)$  is therefore  $\pm(c_0yt^2 + (a_0x + d_0w) + b_0zt^{-2})$ , which diverges as  $t$  tends to either 0 or infinity since  $b_0c_0yz \neq 0$ . Thus the two ideal points of  $\mathbb{C}^*$  are sent to ideal points of  $Y_0$  and  $\tilde{f}_{a_+(a_+b_+)^k a_-}$  has a pole at each of them. Thus  $Y_0$  has at most two ideal points. It has only one if the two ideal points of  $\mathbb{C}^*$  are sent to the same ideal point of  $Y_0$ .

To complete the proof, suppose that  $g(t) = g(t')$ . Then there is a  $B \in PSL_2(\mathbb{C})$  such that  $\rho_{t'} = B\rho_t B^{-1}$ . In particular,  $B\rho_+ B^{-1} = \rho_+$  and  $B\rho_- B^{-1} = \rho_-^{t'}$ . Since

- $\rho_+$  is irreducible, either  $B = \pm I$  or, up to conjugation, the image of  $\rho_+$  is  $\mathcal{K} = \{\pm I, \pm \begin{pmatrix} i & 0 \\ 0 & -i \end{pmatrix}, \pm \begin{pmatrix} 0 & 1 \\ -1 & 0 \end{pmatrix}, \pm \begin{pmatrix} 0 & i \\ i & 0 \end{pmatrix}\}$  and  $B \in \mathcal{K}$ .
- $\rho_-$  is irreducible, either  $B = \pm \begin{pmatrix} t'/t & 0 \\ 0 & t/t' \end{pmatrix}$  or, up to conjugation, the image of  $\rho_-$  is  $\mathcal{K}$  and  $\pm \begin{pmatrix} 1/t' & 0 \\ 0 & t' \end{pmatrix} B \begin{pmatrix} t & 0 \\ 0 & 1/t \end{pmatrix} \in \mathcal{K}$ .

Hence if neither  $\rho_+$  nor  $\rho_-$  has image isomorphic to  $\Delta(2, 2, 2) \cong \mathcal{K}$ , then  $\pm I = B = \pm \begin{pmatrix} t'/t & 0 \\ 0 & t/t' \end{pmatrix}$ . Hence  $t' = \pm t$ . It follows that the two ideal points of  $\mathbb{C}^*$  are sent to distinct ideal points of  $Y_0$ .

On the other hand, suppose that  $p_\epsilon = q_\epsilon = d = 2$  for some  $\epsilon$ . By Lemma 6.2, the image of  $\rho_\epsilon$  is isomorphic to  $\Delta(2, 2, 2)$  and we can suppose that this image is  $\mathcal{K}$ . In this case,  $\rho_+(a_+b_+) = \begin{pmatrix} i & 0 \\ 0 & -i \end{pmatrix} \in \mathcal{K}$ . If  $\epsilon = +$ , the reader will verify that conjugation by  $B = \pm \begin{pmatrix} 0 & 1 \\ -1 & 0 \end{pmatrix}$  takes  $\rho_t$  to  $\rho_{\frac{1}{t}}$ . Thus  $g(t) = g(\frac{1}{t})$ . It follows that  $g$  sends the two ideal points of  $\mathbb{C}^*$  to the same ideal point of  $Y_0$ . Similarly, if  $\epsilon = -$ , conjugation by  $B = \pm \begin{pmatrix} 0 & 1/t \\ -t & 0 \end{pmatrix}$  takes  $\rho_t$  to  $\rho_{\frac{1}{t}}$ . Thus  $g(t) = g(\frac{1}{t})$ , so again  $g$  sends the two ideal points of  $\mathbb{C}^*$  to the same ideal point of  $Y_0$ . This completes the proof.  $\diamond$

**6.3. HNN extensions.** Fix integers  $d, n \geq 2$  and consider the presentation  $\Delta(d, n, d) = \langle a, b : a^d = b^n = (ab)^d = 1 \rangle$ . Let  $\psi : \langle a \rangle \rightarrow \langle ab \rangle$  be an isomorphism. Then

$$\psi(a) = (ab)^s$$

where  $1 \leq s \leq d-1$  and  $\gcd(s, d) = 1$ . Form the HNN extension

$$\Delta(d, n, d)_{*\psi} := \langle a, b, t : a^d = b^n = (ab)^d = 1, tat^{-1} = (ab)^s \rangle$$

A homomorphism  $\rho : \Delta(d, n, d)_{*\psi} \rightarrow PSL_2(\mathbb{C})$  can be thought of as a pair  $(\theta, \pm A)$  where  $\theta = \rho|_{\Delta(d, n, d)}$  and  $\pm A = \rho(t) \in PSL_2(\mathbb{C})$  satisfies  $A\theta(a)A^{-1} = \theta(ab)^s$ . Conversely, a pair  $(\theta, \pm A)$  where  $\theta : \Delta(d, n, d) \rightarrow PSL_2(\mathbb{C})$  is a homomorphism and  $A \in PSL_2(\mathbb{C})$  satisfies  $A\theta(a)A^{-1} = \theta(ab)^s$  defines a homomorphism  $\rho : \Delta(d, n, d)_{*\psi} \rightarrow PSL_2(\mathbb{C})$  in the obvious way. We shall write

$$\rho = (\theta, A)$$

Note that  $(\theta, A), (\theta, B) \in R_{PSL_2}(\Delta(d, n, d)_{*\psi})$  if and only if  $B = AS$  for some  $S \in Z_{PSL_2}(\rho(\langle a \rangle))$ . Let  $Z_{PSL_2}^0(\rho(\langle a \rangle))$  denote the component of the identity of  $Z_{PSL_2}(\rho(\langle a \rangle))$ . The map

$$\beta_{(\theta, A)} : Z_{PSL_2}^0(\rho(\langle a \rangle)) \rightarrow X_{PSL_2}(\Delta(d, n, d)_{*\psi}), S \mapsto \chi_{(\theta, AS)}$$

is called the *bending function* of  $(\theta, A)$ . It is shown in [BoiBo, Lemma C.3] that if  $\beta_{(\theta, A)}$  is constant, then  $\theta(\langle a \rangle) \neq \{\pm I\}$  and, after a possible conjugation, either

- $\theta(\Delta(d, n, d)) \subset \mathcal{D}$  and  $A = \pm \begin{pmatrix} 0 & 1 \\ -1 & 0 \end{pmatrix}$ , or
- $\theta(\Delta(d, n, d))$  and  $A$  are contained in the group of upper-triangular matrices.

In particular, if  $\beta_{(\theta, A)}$  is constant, then  $\theta$  is reducible and  $(\theta, A)$  is either reducible or conjugate into  $\mathcal{N}$ .

We say that  $(\theta, A)$  can be *bent non-trivially* if  $\beta_{(\theta, A)}$  is non-constant. In this case, the image of  $\beta_{(\theta, A)}$  is contained in a curve in  $X_{PSL_2}(\Delta(d, n, d)_{*\psi})$ .

**Lemma 6.4.** *There is a homomorphism  $(\theta, A) : \Delta(d, n, d)_{*\psi} \rightarrow PSL_2(\mathbb{C})$  for which*

- (1)  $\theta$  is irreducible.
- (2)  $a, b$  and  $ab$  are sent to elements of order  $d, n$  and  $d$  respectively unless  $(d, n) = (4, 2)$ . In this case  $a, b$  and  $ab$  are sent to elements of order 2.
- (3)(a)  $(\theta, A)$  can be bent non-trivially to produce a curve  $Y_0 \subset X_{PSL_2}(\Delta(d, n, d)_{*\psi})$ .
- (b)  $Y_0$  is strictly non-trivial.
- (c)  $Y_0$  has two ideal points unless  $n = 2$  and  $d \in \{2, 4\}$  (so  $\theta(\Delta(d, n, d)) \cong \Delta(2, 2, 2)$ ), in which case it has one ideal point. For each  $j, l \in \mathbb{Z}$ , the function  $\tilde{f}_{ta^j ta^l}$  has a pole at each ideal point of  $Y_0$ .

*Proof.* If  $(d, n, d)$  is a spherical triple, it is either  $(2, n, 2)$  or  $(3, 2, 3)$ . In either case we take  $\theta$  to be injective with image  $\Delta(d, n, d)$ . Then  $s \equiv \pm 1 \pmod{d}$ , and as there is a unique conjugacy class of elements of order  $d \in \{2, 3\}$  in  $PSL_2(\mathbb{C})$  we can find an  $A \in PSL_2(\mathbb{C})$  such that  $A\theta(a)A^{-1} = \theta(ab)^s$ . Then  $(\theta, A)$  satisfies (1), (2), and (3)(a) (cf. [BoiBo, Lemma C.3]).

If  $(d, n, d)$  is a Euclidean triple, it is either  $(3, 3, 3)$  or  $(4, 2, 4)$ . In the first case we take  $\theta$  to have image  $\Delta(3, 2, 3)$  and note that each element of order 3 in  $\Delta(3, 3, 3)$  is sent to an element of order 3 in  $\Delta(3, 2, 3)$ . In the second case we take  $\theta$  to have image  $\Delta(2, 2, 2)$ . As in the previous paragraph, there is some  $A \in PSL_2(\mathbb{C})$  for which  $(\theta, A)$  is a homomorphism satisfying (1), (2), and (3)(a).

Assume then that  $(d, n, d)$  is a hyperbolic triple. In particular  $d > 2$ . Lemma 6.1 implies that we can find an irreducible representation  $\theta : \mathbb{Z}/d * \mathbb{Z}/n \rightarrow PSL_2(\mathbb{C})$  such that  $\theta(a)$  has order  $d$ ,  $\theta(b)$  has order  $n$  and  $\theta(ab)$  is conjugate to  $\theta(a)^m$ , where  $m$  is a chosen integer such that  $ms + dl = 1$  for some integer  $l$ . Then  $\theta(a)$  is conjugate to  $\theta(ab)^s$  and we can therefore construct a representation  $(\theta, A) : \Delta(d, n, d)_{*\psi} \rightarrow PSL_2(\mathbb{C})$  satisfying (1), (2), and (3)(a).

Next we prove (3)(b). Suppose that the image of  $(\theta, A)$  is conjugate into  $\mathcal{N}$ . Without loss of generality we can suppose that its image is contained in  $\mathcal{N}$ . Then  $A \in \mathcal{N}$  and as  $\theta$  is irreducible, part (2) of the lemma implies that either  $d = 2$  or  $(d, n, d) = (4, 2, 4)$ . In the first case the image of  $\theta$  is the dihedral group  $D_n$  while in the second it is  $D_2$ . In either case we can suppose that

$$\theta(\langle a \rangle) = \{\pm I, \pm \begin{pmatrix} 0 & 1 \\ -1 & 0 \end{pmatrix}\}$$

so, as we noted above, the component of the identity of the centraliser of  $\theta(\langle a \rangle)$  is given by  $\{\pm \begin{pmatrix} z & w \\ -w & z \end{pmatrix} : z, w \in \mathbb{C} \text{ and } z^2 + w^2 = 1\}$ . Set  $\rho_{(z,w)} = (\theta, A \begin{pmatrix} z & w \\ -w & z \end{pmatrix})$  and suppose that the image of  $B\rho_{(z,w)}B^{-1}$  is contained in  $\mathcal{N}$  for some  $B \in PSL_2(\mathbb{C})$ .

If  $n > 2$ , then  $\rho_{(z,w)}(b) = \theta(b) \in \mathcal{D}$  and so as  $B\rho_{(z,w)}(b)B^{-1} \in \mathcal{N}$ , we must have  $B\rho_{(z,w)}(b)B^{-1} = \theta(b)^{\pm 1}$ . It follows that  $B \in \mathcal{N}$ . But then as  $BA \begin{pmatrix} z & w \\ -w & z \end{pmatrix} B^{-1} \in \mathcal{N}$ , so  $\begin{pmatrix} z & w \\ -w & z \end{pmatrix} \in \mathcal{N}$  and therefore  $z = 0$  or  $w = 0$ . Hence if  $zw \neq 0$  and  $n > 2$ ,  $\rho_{(z,w)}$  does not conjugate to a representation with values in  $\mathcal{N}$  and so  $Y_0$  is strictly non-trivial.

Suppose that  $n = 2$ . Then the image of  $\theta$  is  $D_2$ . If the image of  $\rho_{(z,w)}$  contains a diagonal element of order different than 2, we can proceed as in the case  $n > 2$  to complete the proof that  $Y_0$  is strictly non-trivial. Otherwise the image of  $\rho_{(z,w)}$  coincides with the image of  $\theta$ , which we can take to be  $\mathcal{K} = \{\pm I, \pm \begin{pmatrix} i & 0 \\ 0 & -i \end{pmatrix}, \pm \begin{pmatrix} 0 & 1 \\ -1 & 0 \end{pmatrix}, \pm \begin{pmatrix} 0 & i \\ i & 0 \end{pmatrix}\}$ . Hence  $A$  is an element of the abelian group  $\mathcal{K}$  and so  $\theta(ab)^s = A\theta(a)A^{-1} = \theta(a)$ . Since  $\theta(a)$  has order 2 and  $s$  is odd, we have  $\theta(ab) = \theta(a)$ . But this is impossible as  $\theta(a)$  and  $\theta(ab)$  generate  $\mathcal{K}$ . This completes the proof of (3)(b).

Finally we prove (3)(c). We assume, without loss of generality, that  $\theta(a)$  is diagonal, say

$$\theta(a) = \pm \begin{pmatrix} u & 0 \\ 0 & u^{-1} \end{pmatrix},$$

so  $Z_{PSL_2}^0(\theta(\langle a \rangle)) = \mathcal{D} \cong \mathbb{C}^*$ . Then there is a regular map

$$g : \mathbb{C}^* \rightarrow Y_0, r \mapsto \chi_{\rho_r}, \rho_r = (\theta, \pm A \begin{pmatrix} r & 0 \\ 0 & r^{-1} \end{pmatrix})$$

which factors through  $\mathbb{C}^*/\{\pm 1\} \cong \mathbb{C}^*$ .

Write  $A = \pm \begin{pmatrix} x & y \\ z & w \end{pmatrix}$  and fix an integer  $k$  so that  $sk \equiv 1 \pmod{d}$ . Then as  $\theta$  is irreducible and  $A\theta(a)^k A^{-1} = \theta(ab)^{sk} = \theta(ab)$ , the reader will verify that  $x \neq 0$  and  $w \neq 0$ . A short calculation then shows that

$$\rho_r(ta^j ta^l) = \pm \begin{pmatrix} u^{(j+l)}x^2r^2 + u^{(l-j)}yz & * \\ * & u^{-(j+l)}w^2r^{-2} + u^{-(l-j)}yz \end{pmatrix}$$

Hence, up to sign, the trace of  $\rho_r(ta^j ta^l)$  is  $(u^{(j+l)}x^2)r^2 + (u^{(l-j)} + u^{-(l-j)})yz + (u^{-(j+l)}w^2)r^{-2}$ , which diverges as  $r$  tends to either 0 or infinity since  $x \neq 0$  and  $w \neq 0$ . Thus, each of the two ideal points of  $\mathbb{C}^*$  is sent to an ideal point of  $Y_0$  under the map  $g$ . Further,  $\tilde{f}_{ta^j ta^l}$  has a pole at each of them.

If  $g(r) = g(r')$ , there is a  $B \in PSL_2(\mathbb{C})$  such that  $\rho_{r'} = B\rho_r B^{-1}$ . In particular,  $\theta = B\theta B^{-1}$  and  $BA \begin{pmatrix} r' & 0 \\ 0 & (r')^{-1} \end{pmatrix} B^{-1} = A \begin{pmatrix} r & 0 \\ 0 & r^{-1} \end{pmatrix}$ . Since  $\theta$  is irreducible, either  $B = \pm I$  or, up to conjugation,

$\theta(\Delta(d, n, d)) = \mathcal{K}$  and  $B \in \mathcal{K}$ . In the former case, a simple calculation shows that  $r' = \pm r$ , while in the latter,  $(d, n)$  is either  $(2, 2)$  or  $(4, 2)$ . In particular, if  $(d, n)$  is neither  $(2, 2)$  nor  $(4, 2)$ , the two ideal points of  $\mathbb{C}^*$  are sent to distinct ideal points of  $Y_0$ .

Suppose then that  $(d, n)$  is either  $(2, 2)$  or  $(4, 2)$  and therefore  $\theta(\Delta(d, n, d)) = \mathcal{K}$ . We have assumed that  $\theta(a)$  is diagonal, so  $\theta(a) = \pm \begin{pmatrix} i & 0 \\ 0 & -i \end{pmatrix}$ , and up to conjugation by  $\pm \begin{pmatrix} \sqrt{i} & 0 \\ 0 & 1/\sqrt{i} \end{pmatrix}$  we can suppose that  $\theta(ab) = \pm \begin{pmatrix} 0 & 1 \\ -1 & 0 \end{pmatrix}$ . It is easy to verify that if  $v \neq 0$  and we set

$$A_v = \pm \begin{pmatrix} v & i/2v \\ iv & 1/2v \end{pmatrix} = \pm \begin{pmatrix} 1 & i/2 \\ i & 1/2 \end{pmatrix} \begin{pmatrix} v & 0 \\ 0 & 1/v \end{pmatrix},$$

then  $A_v \theta(a) A_v^{-1} = \theta(ab) = \theta(ab)^s$ , since  $s$  is odd. Further,  $B = \pm \begin{pmatrix} 0 & i \\ i & 0 \end{pmatrix}$  conjugates  $(\theta, A_v)$  to  $(\theta, A_{\frac{1}{2v}})$ . It follows that  $g$  sends the two ideal points of  $\mathbb{C}^*$  to the same ideal point of  $Y_0$ . Thus  $Y_0$  has a unique ideal point.  $\diamond$

## 7. THE PROOF OF THEOREM 1.2 WHEN $F$ IS A SEMI-FIBRE

In this section we prove the semi-fibre case of Theorem 1.2.

**Proposition 7.1.** *Suppose that  $M$  is a hyperbolic knot manifold which contains an essential twice-punctured torus  $F$  of boundary slope  $\beta$  and let  $\alpha$  be a slope on  $\partial M$  such that  $M(\alpha)$  is an irreducible small Seifert manifold. If  $F$  is a semi-fibre in  $M$ , then  $\Delta(\alpha, \beta) \leq 4$ .*

We divide the proof of Proposition 7.1 into two cases.

**7.1. Proof of Proposition 7.1 when  $M(\alpha)$  is very small.** In this subsection we prove refined versions of the very small case of Proposition 7.1. In fact in this case, we allow the semi-fibre  $F$  to have arbitrary number of punctures.

Recall that the base orbifold of  $M(\alpha)$  is  $S^2(a, b, c)$  where  $a, b, c$  are positive integers. The condition that  $M(\alpha)$  be very small corresponds to the requirement that either  $\min\{a, b, c\} = 1$  or  $(a, b, c)$  is a Platonic or a Euclidean triple.

If  $\min\{a, b, c\} = 1$  the fundamental group of  $\pi_1(M(\alpha))$  is cyclic and we say that  $\alpha$  is a *C-type filling slope*.

If  $(a, b, c)$  is a Platonic triple we say that  $\alpha$  is, respectively, a *D-type*, *T-type*, *O-type* or *I-type filling slope* if up to permutation  $(a, b, c)$  is, respectively,  $(2, 2, n)$ ,  $(2, 3, 3)$ ,  $(2, 3, 4)$ , or  $(2, 3, 5)$ .

Finally,  $(a, b, c)$  is a Euclidean triple when  $(a, b, c)$  is one of  $(2, 3, 6)$ ,  $(2, 4, 4)$ , or  $(3, 3, 3)$ .

**Proposition 7.2.** *Let  $M$  be a hyperbolic knot manifold that contains an  $m$ -punctured torus semi-fibre with boundary slope  $\beta$ , and let  $\alpha$  be a slope on  $\partial M$  such that  $M(\alpha)$  is an irreducible very small Seifert manifold. Then*

- (1)  $M(\alpha)$  is not of *T-* or *I-type*.
- (2) If  $M(\alpha)$  is of *C-type* or has base orbifold  $S^2(3, 3, 3)$  then  $\Delta(\alpha, \beta) = 1$  and  $m = 2$ .
- (3) If  $M(\alpha)$  is of *O-type* or has base orbifold  $S^2(2, 3, 6)$  then either

- $\Delta(\alpha, \beta) = 1$  and  $m = 2$  or  $6$ , or
- $\Delta(\alpha, \beta) = 3$  and  $m = 2$ .

(4) If  $M(\alpha)$  has base orbifold  $S^2(2, 4, 4)$  then either

- $\Delta(\alpha, \beta) = 1$  and  $m = 2, 4$  or  $8$ , or
- $\Delta(\alpha, \beta) = 2$  and  $m = 2$  or  $4$ , or
- $\Delta(\alpha, \beta) = 4$  and  $m = 2$ .

(5) If  $M(\alpha)$  is of  $D$ -type, then  $\Delta(\alpha, \beta) \leq 3$ .

**Proof.** The semi-fibre  $F$  separates  $M$  into two components  $X^+$  and  $X^-$  each a twisted  $I$ -bundle over an  $\frac{m}{2}$ -punctured Klein bottle. Hence  $\pi_1(F)$  is an index two subgroup of  $\pi_1(X^\epsilon)$  for each  $\epsilon \in \{\pm\}$  and there is an epimorphism  $\varphi : \pi_1(M) \rightarrow \mathbb{Z}/2 * \mathbb{Z}/2$  whose kernel is  $\pi_1(F)$ . Clearly  $\varphi(\beta) = 1$ . We use  $x$  and  $y$  to denote the generators of the two  $\mathbb{Z}/2$  factors. Let  $\beta^*$  be a dual slope to  $\beta$  on  $\partial M$ , then we may assume that each component of  $\beta^* \cap X^\epsilon$  is an  $I$ -fibre of  $X^\epsilon$ . Choose a disk region in  $F$ , which contains  $F \cap \beta^*$ , as a fat base point for each of  $F, X^\epsilon, M, M(\beta), M(\alpha)$ . Then each component of  $\beta^* \cap X^\epsilon$  represents an element of  $\pi_1(X^\epsilon)$  which is not contained in  $\pi_1(F)$ , and thus its image under  $\varphi$  is the generator of one of the  $\mathbb{Z}/2$  factors. It follows that  $\varphi(\beta^*) = (xy)^{m/2}$ , at least up to exchanging  $x$  and  $y$ .

Write  $\alpha = (\beta^*)^p \beta^q$  where  $p = \Delta(\alpha, \beta)$ . Then  $\varphi(\alpha) = \varphi(\beta^*)^p = (xy)^{mp/2}$ . It follows that  $\varphi$  induces a surjective homomorphism  $\bar{\varphi} : \pi_1(M(\alpha)) \rightarrow (\mathbb{Z}/2 * \mathbb{Z}/2) / \langle\langle (xy)^{mp/2} \rangle\rangle = \langle x, y; x^2 = y^2 = (xy)^{mp/2} = 1 \rangle = D_{mp/2}$ . Set  $n = mp/2$ . As  $H_1(D_n) \cong \mathbb{Z}/2$  ( $n$  odd) and  $\mathbb{Z}/2 \oplus \mathbb{Z}/2$  ( $n$  even) while a very small Seifert manifold of type  $T$  or  $I$  has odd order first homology, part (1) of the proposition holds. When  $n > 1$ ,  $D_n$  is an irreducible subgroup of  $PSL_2(\mathbb{C})$ . So if  $M(\alpha)$  is of  $C$ -type, then  $n = 1$  which means  $p = \Delta(\alpha, \beta) = 1$  and  $m = 2$ . Hence when  $\Delta(\alpha, \beta) > 1$ , the base orbifold of  $M(\alpha)$  is  $S^2(a, b, c)$  with  $a, b, c \geq 2$  and the surjective homomorphism  $\bar{\varphi}$  must factor through  $\pi_1(S^2(a, b, c)) = \Delta(a, b, c)$  ([BeBo, Lemma 3.1]). But then at least two of  $a, b, c$  are even as otherwise the abelianisation of  $\Delta(a, b, c)$  is of odd order and so there is no surjective homomorphism  $\Delta(a, b, c) \rightarrow D_n$ . In particular  $(a, b, c) \neq (3, 3, 3)$ . So (2) holds.

In the case that  $\alpha$  is of  $O$ -type (i.e.  $(a, b, c) = (2, 3, 4)$  or  $(a, b, c) = (2, 3, 6)$ ), then  $n = 1$  or  $3$  since  $D_3$  is the only irreducible dihedral group which is a quotient of either  $\Delta(2, 3, 4)$  or  $\Delta(2, 3, 6)$  (cf. [BZ1, Lemma 5.3], [Bo, Proposition 5.4]). This yields (3).

Similarly, if  $(a, b, c) = (2, 4, 4)$ , then  $n = 1, 2$  or  $4$  (cf. [Bo, Proposition 5.3]), which gives (4).

Finally, suppose that  $\alpha$  is of  $D$ -type. Then  $(a, b, c) = (2, 2, l)$  for some  $l \geq 2$  and therefore  $\alpha$  is a Klein bottle filling slope on  $\partial M$ . By assumption  $\beta$  is also a Klein bottle filling slope. It then follows from [MS, Theorem 1.1] that  $\Delta(\alpha, \beta) \leq 4$ . Further, such triples  $(M; \alpha, \beta)$  with  $\Delta(\alpha, \beta) = 4$  are determined by Lee in [L1]. One checks that in all cases both  $M(\alpha)$  and  $M(\beta)$  are toroidal. Here are the details.

Lee ([L1]) defines two infinite families of hyperbolic knot manifolds:

- $X_n$ ,  $n \in \mathbb{Z}$ , each having a pair of Klein bottle Dehn filling slopes  $\alpha_n$  and  $\beta_n$  with  $\Delta(\alpha_n, \beta_n) = 4$ ,
- $Y(r)$ ,  $r \notin \{\infty, 0, 4\}$ , where  $Y(r)$  is the  $r$ -Dehn filling of the exterior  $Y$  of a 2-component link in  $S^3$  for which  $Y(r)(0)$  and  $Y(r)(4)$  contain Klein bottles,

and shows that any triple  $(M; \alpha, \beta)$  such that  $M(\alpha)$  and  $M(\beta)$  contain Klein bottles with  $\Delta(\alpha, \beta) = 4$  is homeomorphic to either  $(X_n; \alpha_n, \beta_n)$  for some  $n \in \mathbb{Z}$ , or  $(Y(r); 0, 4)$  for some  $r \neq \infty, 0$ , or 4.

Now  $X_n$  is obtained by Dehn filling along one boundary component of  $M_2 \cong N(-1/2)$ , the exterior of the 10/3 2-bridge link ([L1]). Comparing the parametrisations of the exceptional slopes  $\{\infty, -2, -1, 0, 1, 2\}$  in [L1] and  $\{\infty, -4, -3, -2, -1, 0\}$  in [MP, Table A.1], we see that  $X_n \cong N(-1/2, (2n-5)/2) \cong N(-1/2, -(2n+3)/2)$ , where the second homeomorphism follows from [MP, Proposition 1.5(4)]. An examination of Table A.8 and (for the case  $N(-1/2, -5/2) \cong N(-1/2, -3/2)$ ) Table A.4 in [MP] now shows that  $\{\alpha_n, \beta_n\} = \{-4, 0\}$  and  $X_n(\alpha_n)$  and  $X_n(\beta_n)$  are toroidal.

Finally we consider the manifolds  $Y(r)$ . By [L1],  $Y(0) \cong Y(4) \cong Q(2, 2) \cup Wh$ , and the Klein bottle fillings on  $Y(r)$  are  $Y(r)(0) \cong Y(0, r)$  and  $Y(r)(4) \cong Y(0, 4-r)$  (see [L1, Lemma 2.2]). Now  $Y(0, r) \cong Q(2, 2) \cup Wh(r)$ , with the induced parametrisation of slopes on  $Wh$ . From Lemma 2.4 of [L1] we have that  $Wh(2) \cong Q(2, 4)$  and  $Wh(3) \cong Q(2, 3)$ , so from Table A.1 of [MP] it follows that this parametrisation of slopes on  $Wh$  is related to the standard parametrisation on  $N(-1)$  by  $Wh(r) \cong N(-1, r-3)$ . Since  $r \neq \infty$ , Table A.1 of [MP] shows that  $Wh(r)$  has incompressible boundary, and hence  $Y(0, r)$  is toroidal. Part (5) is proved  $\diamond$

We can refine the bounds given in Proposition 7.2 in certain situations, which we describe next.

The semi-fibre  $F$  splits  $M$  into two components  $X^+, X^-$  and if  $\widehat{F}$  denotes the closed surface in  $M(\beta)$  obtained by attaching disjoint meridian disks of the  $\beta$ -filling solid torus to  $F$ , then  $\widehat{F}$  splits  $M(\beta)$  into two twisted  $I$ -bundles  $\widehat{X}^+$  and  $\widehat{X}^-$  over the Klein bottle. Let  $\phi_\epsilon$  denote the slope on  $\widehat{F}$  of the Seifert fibre structure on  $\widehat{X}^\epsilon$  with base orbifold  $D^2(2, 2)$  and set

$$d = \Delta(\phi_+, \phi_-)$$

We consider constraints on  $d$ ,  $M(\alpha)$  when  $\Delta(\alpha, \beta) > 1$ . Given the latter condition, Proposition 7.2 implies that  $\alpha$  has type  $D$  or  $O$ , or  $(a, b, c)$  is either  $(2, 3, 6)$  or  $(2, 4, 4)$ .

**Proposition 7.3.** *Suppose that  $F$  is an  $m$ -punctured semi-fibre and that  $\alpha$  has type  $O$ , so  $(a, b, c) = (2, 3, 4)$ , or  $(a, b, c)$  is either  $(2, 3, 6)$  or  $(2, 4, 4)$ . Suppose further that  $d \neq 1$  and  $\Delta(\alpha, \beta) > 1$ . Then  $(a, b, c) = (2, 4, 4)$  and  $\Delta(\alpha, \beta) = 2$ .*

**Proof.** We saw in the proof of Proposition 7.2 that there is an epimorphism

$$\varphi_1 : \pi_1(M(\beta)) \rightarrow \mathbb{Z}/2 * \mathbb{Z}/2$$

whose kernel is  $\pi_1(\widehat{F})$ . Pulling back the curve  $X(1, 1) \subset X_{PSL_2}(\mathbb{Z}/2 * \mathbb{Z}/2)$  of §6.1 produces a curve

$$X_1 = (\varphi_1)^*(X(1, 1)) \subset X_{PSL_2}(M(\beta)) \subset X_{PSL_2}(M)$$

More generally, for each positive integer  $d'$  dividing  $d$  we can construct a curve  $X_{d'}$  in the character variety of  $M$  as follows.

Killing the fibre classes  $\phi_+, \phi_-$  in  $\pi_1(M(\beta))$  yields a surjection

$$\varphi_d : \pi_1(M(\beta)) \rightarrow \Delta(2, 2, d) *_{\mathbb{Z}/d} \Delta(2, 2, d)$$

where in the case that  $d = 0$  we take  $\Delta(2, 2, d)$  to be  $\mathbb{Z}/2 * \mathbb{Z}/2$  and  $\mathbb{Z}/d$  to be the central  $\mathbb{Z}$  of index 2 in each of the  $(\mathbb{Z}/2 * \mathbb{Z}/2)$ -factors.

If  $d \geq 2$  let  $Y_d \subset X_{PSL_2}(\Delta(2, 2, d) *_{\psi} \Delta(2, 2, d))$  be a curve constructed by bending a representation  $\Delta(2, 2, d) *_{\psi} \Delta(2, 2, d) \rightarrow PSL(2, \mathbb{C})$  which restricts to an irreducible representation with image  $D_d$  on each of the two copies of  $\Delta(2, 2, d)$ . (See Lemma 6.3.) Set

$$X_d = (\varphi_d)^*(Y_d) \subset X_{PSL_2}(M(\beta)) \subset X_{PSL_2}(M)$$

Lemma 6.3(3) shows that  $X_d$  has exactly one ideal point if  $d = 2$  and two if  $d > 2$ . Further,  $\tilde{f}_{\beta^*}$  has a pole at each ideal point of  $X_d$  so that  $s_{X_d} \geq 1$  if  $d = 2$  and  $s_{X_d} \geq 2$  if  $d > 2$ .

In the case that  $d = 0$ , one can use the method of proof of Lemmas 6.1, 6.2, and 6.3 to produce a non-trivial curve  $Y_0$  in  $X_{PSL_2}((\mathbb{Z}/2 * \mathbb{Z}/2) *_{\mathbb{Z}} (\mathbb{Z}/2 * \mathbb{Z}/2))$  obtained by bending an irreducible homomorphism  $(\mathbb{Z}/2 * \mathbb{Z}/2) *_{\mathbb{Z}} (\mathbb{Z}/2 * \mathbb{Z}/2) \rightarrow PSL_2(\mathbb{C})$  for which  $\rho(a_+ b_+)$  is an element of infinite order in  $PSL_2(\mathbb{C})$ . In particular, the image of each representation with character in  $Y_0$  is irreducible and infinite. As above,

$$X_0 = (\varphi_0)^*(Y_0) \subset X_{PSL_2}(M(\beta)) \subset X_{PSL_2}(M)$$

has two ideal points and  $\tilde{f}_{\beta^*}$  has a pole at each of them. Hence  $s_{X_0} \geq 2$ .

Similarly, if  $d' > 1$  is a positive integer dividing  $d$  we can use the obvious quotient homomorphism

$$\pi_1(M(\beta)) \rightarrow \Delta(2, 2, d) *_{\mathbb{Z}/d} \Delta(2, 2, d) \rightarrow \Delta(2, 2, d') *_{\mathbb{Z}/d'} \Delta(2, 2, d')$$

to construct a curve

$$X_{d'} \subset X_{PSL_2}(M(\beta)) \subset X_{PSL_2}(M)$$

each of whose characters is irreducible. Further,  $s_{X_{d'}} \geq 1$  if  $d' = 2$  and  $s_{X_{d'}} \geq 2$  if  $d' > 2$ .

By construction, the image of each representation whose character lies on some  $X_{d'}$  contains a normal subgroup isomorphic to  $\mathbb{Z}/d'$ .

It is shown in [BeBo, Lemma 3.1] that if  $\rho : \pi_1(M(\alpha)) \rightarrow PSL_2(\mathbb{C})$  has non-diagonalisable image and has a non-trivial character, then it factors through the triangle group  $\Delta(a, b, c)$ . Therefore by Lemma 5.3 of [BZ1] and Propositions 5.3 and 5.4 of [Bo],  $\rho$  has image

$$\text{image}(\rho) \cong \begin{cases} D_3 \text{ or } O_{24} = \Delta(2, 3, 4) & \text{if } \alpha \text{ is of } O\text{-type} \\ D_3 \text{ or } T_{12} = \Delta(2, 3, 3) & \text{if } (a, b, c) = (2, 3, 6) \\ D_2 \text{ or } D_4 & \text{if } (a, b, c) = (2, 4, 4) \end{cases}$$

In particular, the image of  $\rho$  is a finite group whose non-trivial elements have order 2, 3, or 4.

No  $X_{d'}$  contains the character of a representation with image  $T_{12}$  or  $O_{24}$ . This is clear when  $d' = 1$  since neither of these groups is generated by two elements of order 2, and it is true when

$d' > 1$  since neither  $T_{12}$  nor  $O_{24}$  contain non-trivial cyclic normal subgroups. Thus the only representations of  $\pi_1(M(\alpha))$  whose characters lies on some  $X_{d'}$  have image  $D_2, D_3$ , or  $D_4$ .

Each of the curves  $X_{d'}$  we constructed above has  $s_{X_{d'}} > 0$  and so as

$$\|\alpha\|_{X_{d'}} = \Delta(\alpha, \beta) s_{X_{d'}}$$

(cf. (5.0.2)) and  $\Delta(\alpha, \beta) > 1$ ,  $J_{X_{d'}}(\alpha) \neq \emptyset$  for each  $d'$ . Note as well that since  $\tilde{f}_{\beta^*}$  has a pole at each ideal point of  $X_{d'}$ , so does  $\tilde{f}_\alpha = \tilde{f}_{(\beta^*)^p}$  where  $p = \Delta(\alpha, \beta) > 1$ . Hence, any element of  $J_{X_{d'}}(\alpha)$  is contained in  $X_{d'}^\vee$  and if its image in  $X_{d'}$  is the character  $\chi_\rho$ , then  $\chi_\rho$  is a smooth point of  $X_{PSL_2}(M)$  (Lemma 5.1). In particular,  $X_{d'}$  is the unique curve in  $X_{PSL_2}(M)$  containing it. We know, again by Lemma 5.1, that  $\rho(\alpha) = \pm I$ , and so  $\rho$  induces irreducible homomorphism

$$\bar{\rho} : \pi_1(M(\alpha)) \rightarrow PSL(2, \mathbb{C})$$

Thus the image of  $\rho$  is  $D_2, D_3$ , or  $D_4$ . This excludes the possibility that  $d' = 0$  as all representations with characters on  $X_0$  have infinite image. It also excludes the possibility that  $d' > 4$ . Thus  $d \in \{2, 3, 4\}$ .

Since  $d > 1$ , there are at least two curves  $X_1$  and  $X_d$ , and as  $\Delta(\alpha, \beta) > 1$ , each has  $J_{X_{d'}}(\alpha) \neq \emptyset$  and therefore contains the character of a representation with dihedral image. This rules out the cases that  $(a, b, c)$  is either  $(2, 3, 4)$  or  $(2, 3, 6)$ , since these groups admit a unique character of an irreducible representation with dihedral image. Thus  $\Delta(\alpha, \beta) \leq 1$  when  $d \neq 1$  and  $(a, b, c) = (2, 3, 4)$  or  $(2, 3, 6)$ .

Finally suppose that  $(a, b, c) = (2, 4, 4)$ . Then  $\pi_1(M(\alpha))$  admits exactly three irreducible characters of representations with values in  $PSL(2, \mathbb{C})$ , one with image  $D_2$  and two with image  $D_4$ , by Proposition 5.3 of [BeBo]. Thus  $d$  is either 2 or 4, as is  $\Delta(\alpha, \beta)$  by Proposition 5.2. Further, the latter result implies that if  $\Delta(\alpha, \beta) = 4$ , each of disjoint  $X_1, X_2$  and  $X_4$  contains at least two elements of  $J_{X_{d'}}(\alpha)$ , which is impossible. Thus  $\Delta(\alpha, \beta) = 2$ .  $\diamond$

**7.2. Proof of Proposition 7.1 when  $M(\alpha)$  is not very small.** In this subsection we verify Proposition 7.1 in the case that  $M(\alpha)$  is not very small.

There is a unique 2-fold cover  $\widetilde{M} \rightarrow M$  where  $\widetilde{M}$  is an  $F$ -bundle over  $S^1$ . Indeed, using the notation of the proof of Lemma 7.2, it corresponds to the composition of  $\varphi$  with the epimorphism  $\mathbb{Z}/2 * \mathbb{Z}/2 \rightarrow \mathbb{Z}/2$  with kernel  $\langle xy \rangle$ . Let  $\theta$  denote the covering involution of this cover. The reader will verify that  $\partial \widetilde{M}$  has two boundary components  $T_1$  and  $T_2$ , so the covering map restricts to a homeomorphism between  $T_i$  and  $\partial M$  for each  $i$ . Hence each slope  $\gamma$  on  $\partial M$  lifts to a slope  $\gamma_i$  on  $T_i$  ( $i = 1, 2$ ) such that  $\theta(\gamma_1) = \gamma_2$ . Thus there is an induced 2-fold cover  $\widetilde{M}(\gamma_1, \gamma_2) \rightarrow M(\gamma)$ .

Pull back the Seifert structure on  $M(\alpha)$  to  $\widetilde{M}(\alpha_1, \alpha_2)$ . The base orbifold  $\mathcal{B}$  of  $\widetilde{M}(\alpha_1, \alpha_2)$  covers that of  $M(\alpha)$  with degree 1 or 2, and so is either  $S^2(a, b, c)$  or  $S^2(\frac{a}{2}, \frac{b}{2}, c, c)$ , at least up to a permutation of  $a, b, c$ . Since  $M(\alpha)$  is not very small,  $\mathcal{B}$  has at least three cone points. In particular,  $\widetilde{M}(\alpha_1, \alpha_2)$  is not a lens space.

**Lemma 7.4.** *Suppose that  $M$  is a hyperbolic knot manifold which contains an essential twice-punctured torus  $F$  of boundary slope  $\beta$  and let  $\alpha$  be a slope on  $\partial M$  such that  $M(\alpha)$  is an*



irreducible small Seifert manifold. Suppose as well that  $F$  is a semi-fibre in  $M$  and  $M(\alpha)$  is not very small. If  $\Delta(\alpha, \beta) > 1$ , then the cover  $\mathcal{B} \rightarrow S^2(a, b, c)$  has degree 2 so for some permutation of  $a, b, c$  we can suppose that  $a$  and  $b$  are even and that  $\mathcal{B} \cong S^2(a/2, b/2, c, c)$ . Further,  $c \geq 2\Delta(\alpha, \beta) - 2$ .

*Proof.* Let  $X_0 \subset X_{PSL_2}(M)$  be the  $\mathbb{Z}/2 * \mathbb{Z}/2$ -curve  $X_0$  constructed in the proof of Lemma 7.2. From the description of  $\widetilde{M} \rightarrow M$  above, the image of  $X_0$  in  $X_{PSL_2}(\widetilde{M})$  is a curve of characters of representations which factor through the cyclic subgroup  $\langle xy \rangle$  of  $\mathbb{Z}/2 * \mathbb{Z}/2$ . Hence the image is a curve of reducible characters. We saw in the proof of Lemma 7.2 that  $J_{X_0}(\alpha) \subset X_0^\nu = X_0$  and that each element of  $J_{X_0}(\alpha)$  is irreducible.

Suppose that  $\Delta(\alpha, \beta) > 1$ . If  $\chi_\rho \in J_{X_0}(\alpha)$ , then  $\rho$  factors through a homomorphism  $\bar{\rho} : \pi_1(S^2(a, b, c)) \rightarrow PSL_2(\mathbb{C})$  (Lemma 5.1), and therefore the restriction of  $\rho$  to  $\pi_1(\widetilde{M})$  factors through  $\bar{\rho}|_{\pi_1(\mathcal{B})}$ . The image of  $\rho$ , and therefore that of  $\bar{\rho}$ , is a dihedral group  $D_n$  where  $n \geq 2$  divides  $\Delta(\alpha, \beta)$ . Since  $\rho$  is irreducible, but  $\rho|_{\pi_1(\widetilde{M})}$  is reducible,  $\rho(\pi_1(\widetilde{M})) = \bar{\rho}(\pi_1(\mathcal{B}))$  is the index 2 cyclic subgroup  $C_n$  of  $D_n$ . Thus the cover  $\mathcal{B} \rightarrow S^2(a, b, c)$  must have degree 2. It follows that after possibly permuting  $a, b, c$ , we can suppose that  $a$  and  $b$  are even and that  $\mathcal{B} \rightarrow S^2(a, b, c)$  is the obvious cover  $S^2(a/2, b/2, c, c) \rightarrow S^2(a, b, c)$ . This proves the first assertion of the lemma.

In order to prove the second assertion, note that by the previous paragraph the generators of order  $a$  and  $b$  in  $\pi_1(S^2(a, b, c))$  are sent to  $D_n - C_n$ . Thus  $\bar{\rho}$  factors through the dihedral group  $\Delta(2, 2, c) \cong D_c$  in the obvious way. Hence, for each  $\chi_{\rho'} \in J_{X_0}(\alpha)$ ,  $\rho'$  factors as a composition  $\pi_1(M) \rightarrow \pi_1(M(\alpha)) \rightarrow \pi_1(S^2(a, b, c)) \rightarrow \Delta(2, 2, c) \rightarrow PSL_2(\mathbb{C})$ . Since there are  $\lfloor \frac{c}{2} \rfloor$  characters of irreducible representations  $\Delta(2, 2, c) \rightarrow PSL_2(\mathbb{C})$  and the image of each one conjugates into  $\mathcal{N}$ , Proposition 5.1(3) implies that  $\Delta(\alpha, \beta) \leq 1 + \lfloor \frac{c}{2} \rfloor$ . Hence  $c \geq 2\Delta(\alpha, \beta) - 2$ , which completes the proof.  $\diamond$

We will make use of the involution  $\tau_F$  depicted in Figure 2. It is central in the mapping class group of  $F$ . The quotient  $F/\tau_F$  is the 2-orbifold  $D^2(2, 2, 2, 2)$ .

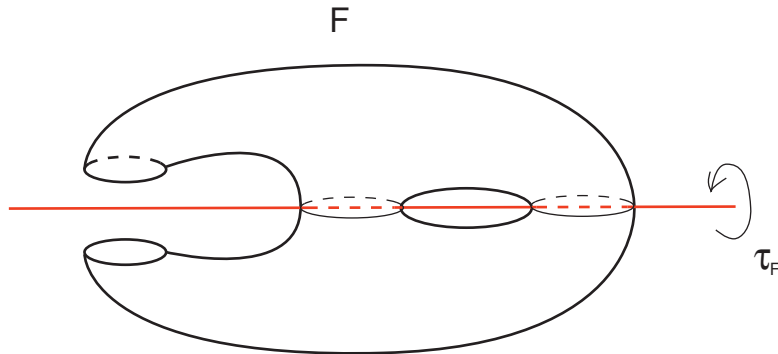

FIGURE 2.

There is an involution  $\tau$  on  $\widetilde{M}$  induced by  $\tau_F$ . The quotient  $\widetilde{M}/\tau$  is homeomorphic to  $(V, L)$  where  $V$  is a solid torus and  $L$  is a 4-braid. We claim that for each slope  $\gamma$  on  $\partial M$ ,  $\tau$  induces

an involution  $\tau_\gamma$  of each  $\widetilde{M}(\gamma_1, \gamma_2)$ . To see this, note that  $\tau$  is the lift of an involution  $\tau_0$  of  $M$  obtained by applying  $\tau_F$  semi-fibre by semi-fibre. Then  $\tau_0$  restricts to a hyperelliptic involution of  $\partial M$ , and so acts on  $H_1(\partial M)$  by multiplication by  $-1$ . Since  $\tau$  is a lift of  $\tau_0$ , the isomorphism  $\tau_* : H_1(T_1) \rightarrow H_1(T_2)$  is multiplication by  $-1$  under the identification induced by  $\theta$ . In particular,  $\tau$  sends the slope  $\gamma_1$  to  $\gamma_2$ , which is what we needed to prove.

The restriction of the quotient map  $\widetilde{M} \rightarrow V$  to each  $T_i$  yields a homeomorphism  $T_i \rightarrow \partial V$  such that for any slope  $\gamma$  on  $\partial M$ ,  $\gamma_1$  and  $\gamma_2$  determine the same slope  $\bar{\gamma}$  on  $\partial V$ . Clearly  $\widetilde{M}(\gamma_1, \gamma_2)/\tau_\gamma = V(\bar{\gamma})$ . Further, the branch set  $L_\gamma \subset V(\bar{\gamma})$  of this quotient is  $L \subset V \subset V(\bar{\gamma})$ .

Note that  $\bar{\beta}$  is a meridian of  $V$  while if  $\beta^*$  is a dual class to  $\beta$ ,  $\bar{\beta}^*$  is a longitude of  $V$ . Thus after possibly changing the sign of  $\alpha$  we can write

$$(7.2.1) \quad \alpha = p\beta^* + q\beta$$

where  $p, q$  are coprime. After possibly changing the signs of  $\beta^*$  and  $\beta$  we may assume that

$$(7.2.2) \quad p = \Delta(\alpha, \beta)$$

By construction

$$(7.2.3) \quad V(\bar{\alpha}) \cong L(p, q)$$

As in the proof of [BGZ3, Lemma 4.1], we can assume that  $\tau_\alpha$  preserves the Seifert structure on  $\widetilde{M}(\alpha_1, \alpha_2)$ .

**Lemma 7.5.** *Suppose that  $M$  is a hyperbolic knot manifold which contains an essential twice-punctured torus  $F$  of boundary slope  $\beta$  and let  $\alpha$  be a slope on  $\partial M$  such that  $M(\alpha)$  is an irreducible small Seifert manifold. Suppose as well that  $F$  is a semi-fibre in  $M$  and  $M(\alpha)$  is not very small. If  $\tau_\alpha$  reverses the orientation of the Seifert fibres of  $\widetilde{M}(\alpha_1, \alpha_2)$ , then  $\Delta(\alpha, \beta) \leq 4$ .*

**Proof.** Suppose that  $\tau_\alpha$  reverses the orientation of the fibres of  $\widetilde{M}(\alpha_1, \alpha_2)$ . The method of proof of [BGZ3, Lemma 4.4] shows that either

- (a)  $\widetilde{M}(\alpha_1, \alpha_2)$  has base orbifold  $S^2(p, p, m)$  for some  $m \geq 2$  where the branch set  $L_\alpha$  in  $L(p, q)$  is a closed  $m/n$ -rational tangle in a Heegaard solid torus as shown in Figure 3 (the example shown in Figure 4 should suffice to illustrate our convention for rational tangles), or
- (b)  $\widetilde{M}(\alpha_1, \alpha_2)$  has base orbifold  $S^2(p, p, m, s)$  for some  $m, s \geq 2$  where the branch set  $L_\alpha$  in  $L(p, q)$  is a closed two tangle Montesinos link with rational tangles  $m/n$  and  $s/t$ .

Pull  $L_\alpha$  back to the universal cover  $S^3$  of  $L(p, q)$  and call the resulting link  $\widetilde{L}_\alpha$ . Then  $\widetilde{L}_\alpha$  is a Montesinos link with  $r \geq p$  rational tangles. The 2-fold cover  $\Sigma_2(\widetilde{L}_\alpha)$  of  $S^3$  branched over  $\widetilde{L}_\alpha$  is Seifert with base orbifold a 2-sphere with  $r$  cone points. By [S, Theorem 5.3] its Heegaard genus is realized by a vertical splitting, of genus  $r - 1$ , unless it is as in case (2) of that theorem, in which case  $r$  is even and  $\geq 4$  and its Heegaard genus is realized by a horizontal splitting of genus  $r - 2$ . On the other hand,  $L_\alpha$  is the image of  $L$  in  $V(\bar{\alpha})$ , so  $\widetilde{L}_\alpha$  is the closure of a 4-braid. Hence the Heegaard genus of  $\Sigma_2(\widetilde{L}_\alpha)$  is at most 3. Hence either  $r - 1 \leq 3$ , or  $r \geq 4$  is even and  $r - 2 \leq 3$ . It follows that  $\Delta(\alpha, \beta) = p \leq r \leq 4$ .  $\diamond$

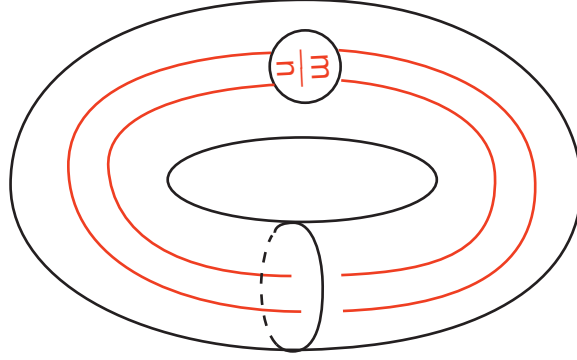

FIGURE 3.

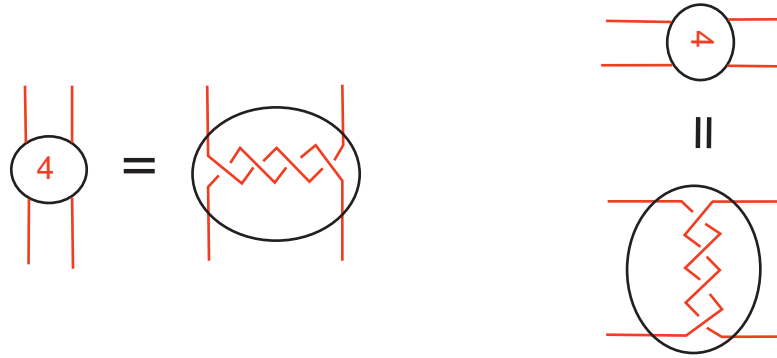

FIGURE 4.

For the rest of this section we suppose that  $\tau_\alpha$  preserves the orientation of the fibres of  $\widetilde{M}(\alpha_1, \alpha_2)$ . As in [BGZ3, Lemma 4.3] we have

**Lemma 7.6.** *Suppose that  $M$  is a hyperbolic knot manifold which contains an essential twice-punctured torus  $F$  of boundary slope  $\beta$  and let  $\alpha$  be a slope on  $\partial M$  such that  $M(\alpha)$  is an irreducible small Seifert manifold. Suppose as well that  $F$  is a semi-fibre in  $M$  and  $M(\alpha)$  is not very small. If  $\tau_\alpha$  preserves the orientation of the Seifert fibres of  $\widetilde{M}(\alpha_1, \alpha_2)$  and  $\Delta(\alpha, \beta) \geq 4$ , then*

- (1) *there is an induced Seifert structure on  $L(p, q) \cong \widetilde{M}(\alpha_1, \alpha_2)/\tau_\alpha$  whose branched set  $L$  is a union of at most four Seifert fibres.*
- (2) *the induced Seifert structure on  $L(p, q)$  has at least one cone point of order  $\Delta(\alpha, \beta) - 1$ .*
- (3)  *$L$  contains at least one regular fibre of  $L(p, q)$  and if only one,  $L(p, q)$  has no exceptional fibre of multiplicity 2.*

*Proof.* By Lemma 7.4,  $\widetilde{M}(\alpha_1, \alpha_2)$  has base orbifold  $S^2(\bar{a}, \bar{b}, c, c)$  and  $c \geq 2(\Delta(\alpha, \beta) - 1)$ . As  $M(\alpha)$  is not very small,  $S^2(\bar{a}, \bar{b}, c, c)$  is hyperbolic.

Let  $\bar{\tau}_\alpha$  be the map of  $S^2(\bar{a}, \bar{b}, c, c)$  induced by  $\tau_\alpha$ . Either  $\bar{\tau}_\alpha$  is the identity or it is an orientation-preserving involution with exactly two fixed points. In the former case, a fibre of multiplicity

$j$  in  $\widetilde{M}(\alpha_1, \alpha_2)$  is sent to a fibre of multiplicity  $\bar{j} = \frac{j}{\gcd(j,2)}$  in  $L(p, q)$ . Further, the fixed point set of  $\tau_\alpha$  is the union of exceptional fibres of  $\widetilde{M}(\alpha_1, \alpha_2)$  of even multiplicity. Hence  $L$  has at most four components. Further, the base orbifold  $\overline{\mathcal{B}}$  of  $L(p, q)$  in the induced Seifert structure is  $S^2(\bar{a}, \bar{b}, \bar{c}, \bar{c})$ . Since  $\bar{c} \geq \Delta(\alpha, \beta) - 1 \geq 3$  (Lemma 7.4) we must have  $\bar{a} = \bar{b} = 1$ . Thus  $a, b \in \{2, 4\}$  and  $\overline{\mathcal{B}} = S^2(\bar{c}, \bar{c})$ . Further, since  $S^2(a, b, c)$  is hyperbolic, at least one of  $a, b$  is 4. It follows that  $L$  contains at least one regular fibre. If there is only one, then  $a = 2$  (say) and  $b = 4$ . It is easy to see that the lemma holds in this situation.

Next suppose that  $\bar{\tau}_\alpha$  is not the identity. In this case  $L$  has at most two components. If  $a = 2$ , then  $\bar{b} > 1$  and  $\mathcal{B} = S^2(\bar{b}, c, c)$ . As  $\bar{\tau}_\alpha$  is not the identity, it fixes exactly one of the cone points of  $\mathcal{B}$ , which necessarily has order  $\bar{b}$ . Denote by  $\phi_1$  the  $\tau_\alpha$ -invariant regular fibre and  $\phi_{\bar{b}}$  the  $\tau_\alpha$ -invariant exceptional fibre. The image in  $L(p, q)$  of  $\phi_1$  is a fibre of multiplicity 1 if  $\phi_1$  lies in the fixed-point set of  $\tau_\alpha$ , and is 2 otherwise. Similarly the image in  $L(p, q)$  of  $\phi_{\bar{b}}$  is a fibre of multiplicity  $\bar{b} > 1$  if  $\phi_{\bar{b}}$  lies in the fixed-point set of  $\tau_\alpha$ , and is  $2\bar{b}$  otherwise. As  $\overline{\mathcal{B}}$  can have only two cone points, it follows that  $\phi_1$  lies in the fixed point set of  $\tau_\alpha$  and that its image in  $L(p, q)$  is a regular fibre contained in  $L$ . Further,  $\overline{\mathcal{B}} = S^2(\bar{b}, c)$  if  $\phi_{\bar{b}}$  is contained in the fixed-point set of  $\tau_\alpha$  and  $S^2(2\bar{b}, c)$  otherwise. It is easy to see that the lemma holds in this situation. A similar argument shows that the lemma holds if  $b = 2$ .

Finally suppose that  $\bar{\tau}_\alpha$  is not the identity and  $a, b > 2$  and define  $\mathcal{F}$  to be the fixed point set of  $\bar{\tau}_\alpha$ . In this case  $S^2(\bar{a}, \bar{b}, c, c)$  contains four cone points. Then  $\mathcal{F}$  contains either two cone points or none. The former case does not occur as otherwise  $\overline{\mathcal{B}}$  would have three cone points (since  $a, b \geq 4$ ). Thus  $\mathcal{F}$  contains no cone points and the two associated regular fibres must lie in the fixed point set of  $\tau_\alpha$ . Thus  $L$  contains two regular fibres and  $\overline{\mathcal{B}} = S^2(\bar{b}, c)$ . This completes the proof in this final case.  $\diamond$

For the rest of this section we suppose that  $\Delta = \Delta(\alpha, \beta) \geq 5$  and show that this leads to a contradiction.

Recall that  $L$  is a 4-braid in the Heegaard solid torus  $V$  in  $L(p, q)$ , and consists of Seifert fibres in the induced Seifert structure on  $L(p, q)$ . Let  $X$  be the exterior of  $L$  in  $L(p, q)$  and  $Y$  the exterior of  $L$  in  $V$ . Thus  $X$  inherits a Seifert structure. By Lemma 7.6(3) at least one component of  $L$  is a regular fibre in  $L(p, q)$ . We distinguish two cases.

**Case I.** *At least two components of  $L$  are regular fibres.*

**Case II.** *Exactly one component of  $L$  is a regular fibre.*

**Lemma 7.7.** *Let  $K$  be a component of  $L$  that is a regular fibre of  $L(p, q)$ . Then*

- (1) *the winding number of  $K$  in  $V$  is greater than 1;*
- (2) *in Case II the winding number of  $K$  in  $V$  is greater than 2.*

*Proof.* Note that because  $L$  is a braid in  $V$ ,  $K$  is too. Since the Seifert structure on  $L(p, q)$  has two exceptional fibres by Lemma 7.6(2), the exterior of a regular fibre has a Seifert structure

with base orbifold  $D^2(a, b)$ ,  $a, b \geq 2$ . If the winding number of  $K$  in  $V$  is 1 then the exterior of  $K$  in  $L(p, q)$  is a solid torus. This proves (1).

To prove (2), suppose  $K$  has winding number 2 in  $V$ ; thus  $K$  is a 2-braid in  $V$ . Then the exterior of  $K$  in  $L(p, q)$  has a Seifert structure with base orbifold of the form  $D^2(2, c)$ . Hence  $a$  or  $b = 2$ , contradicting Lemma 7.6(3).  $\diamond$

It follows from Lemma 7.7 that in Case I  $L$  has exactly two components,  $K_1$  and  $K_2$ , say, each with winding number 2 in  $V$ . Let  $T_1$  and  $T_2$  be the corresponding boundary components of  $X$ . There is a vertical annulus  $A$  in  $X$  with boundary components  $a_1 \subset T_1$ ,  $a_2 \subset T_2$ .

In Case II, let  $K$  be the component of  $L$  that is a regular fibre. By Lemma 7.7, either  $K = L$  or  $L$  has two components  $K$  and  $K'$ , with winding numbers 3 and 1, respectively, in  $V$ . Let  $T_K$  be the boundary component of  $X$  corresponding to  $K$ . There is a vertical essential annulus  $A$  in  $X$ , with  $\partial A \subset T_K$ , separating  $X$  into two components  $X_1$  and  $X_2$ . Note that either  $X_1$  and  $X_2$  are both solid tori, or one is a solid torus and the other is homeomorphic to  $T^2 \times I$ .

In both Cases I and II, choose  $A$  among all annuli with the stated properties to have minimal intersection with the complementary solid torus to  $V$  in  $L(p, q)$ . We adopt the construction and terminology described in [BGZ3, Section 6]. Thus a meridian disk  $D$  of  $V$  gives a properly embedded 4-punctured disk  $P$  in  $Y$ , and from  $A$  we get an essential  $n$ -punctured annulus  $Q$  in  $Y$ . The intersection of  $P$  with  $Q$  defines graphs  $\Gamma_P, \Gamma_Q$  with vertices  $d_V, c_1, c_2, c_3, c_4$  and  $a_1, a_2, b_1, \dots, b_n$ , respectively. Note that in Case II  $n$  is even. Also, since  $L$  is a braid we may orient the components of  $L$  coherently in  $V$ ; then the vertices  $c_1, c_2, c_3, c_4$  all have the same sign. By the remarks after Lemma 7.7, each vertex  $c_j$  of  $\Gamma_P$  has valency 1 in Case I, and in Case II, valency 0 or 2, with at least three having valency 2.

**Lemma 7.8.** *In Case I,  $\Gamma_P$  does not contain a  $D$ -edge Scharlemann cycle.*

*Proof.* Such a Scharlemann cycle could be used to construct an annulus  $A' \subset X$  with  $\partial A' = \partial A$  and having fewer intersections with  $T_V$ .  $\diamond$

**Lemma 7.9.** *In Case II, suppose  $\Gamma_P$  contains a  $D$ -edge Scharlemann cycle of order  $m = 2$  or 3, lying in  $X_i$ . Then  $X_i$  is a solid torus and the core of  $X_i$  is an exceptional fibre of  $X$  of multiplicity  $m$ .*

*Proof.* Let the face of  $\Gamma_P$  bounded by the Scharlemann cycle be  $f$ . Note that the edges of  $\partial f$  in  $\Gamma_Q$  do not lie in a disk in  $A$ , for otherwise  $X_i$  would contain a punctured lens space.

Let  $H$  be the component of the intersection of the filling solid torus  $\overline{L(p, q) - V}$  with  $X_i$  corresponding to the label-pair of the Scharlemann cycle. Define  $W = N(A \cup H \cup f)$ . It is easy to see that  $W$  is a solid torus in which  $A$  has winding number  $m$ . Therefore  $X_i$  is not homeomorphic to  $T^2 \times I$ . Hence  $X_i$  is a solid torus, and so  $\overline{X_i - W}$  is a solid torus in which the annulus that is the frontier of  $W$  in  $X_i$  is longitudinal. It follows that the core of  $X_i$  is an exceptional fibre of  $X$  of multiplicity  $m$ .  $\diamond$

**Corollary 7.10.** *In both Cases I and II,  $\Gamma_P$  does not contain a  $D$ -edge  $S$ -cycle.*

*Proof.* In Case I this follows from Lemma 7.8. In Case II it follows from Lemma 7.9 together with Lemma 7.6(3).  $\diamond$

**Lemma 7.11.** *In Case II,  $\Gamma_P$  does not contain  $D$ -edge Scharlemann cycles  $f_1$  and  $f_2$  on distinct label-pairs that lie in the same component  $X_i$ , where  $f_j$  has order 2 or 3,  $j = 1, 2$ .*

*Proof.* Let  $H_1, H_2 \subset X_i$  be the components of the intersection of the filling solid torus  $\overline{L(p, q) - V}$  with  $X_i$  corresponding to the label-pairs of  $f_1, f_2$ , respectively. Let  $W_1 = N(A \cup H_1 \cup f_1)$ . By the proof of Lemma 7.9,  $W_1$  is a solid torus and the annulus  $A_1$  that is the frontier of  $W_1$  in  $X_i$  is longitudinal in the solid torus  $U = \overline{X_i - W}$ . Let  $W_2 = N(A_1 \cup H'_2 \cup f'_2) \subset U$ , where  $H'_2 = H_2 \cap U$  and  $f'_2 = f_2 \cap U$ . Again by the proof of Lemma 7.9,  $A_1$  has winding number 2 or 3 (the order of the Scharlemann cycle  $f_2$ ) in the solid torus  $W_2$ , and hence in  $U$ . This is a contradiction.  $\diamond$

We will first dispose of Case I, and Case II when  $n \geq 4$ . Note that the valency of  $d_V$  in  $\Gamma_P$  is  $\Delta n \geq 5n$  (since  $\Delta \geq 5$  by assumption).

For an edge  $\bar{e}$  in the reduced graph  $\bar{\Gamma}_P$ , we denote by  $wt(\bar{e})$  the weight of  $\bar{e}$ , i.e. the number of parallel edges represented by  $\bar{e}$ . Let  $\bar{e}$  be a  $D$ -edge of the reduced graph  $\bar{\Gamma}_P$ . We say  $\bar{e}$  is of *type O* if  $\bar{e}$  cuts off a subdisk of  $D$  that contains a single vertex  $c_j$ . Otherwise,  $\bar{e}$  is of *type N*. Define

$$\lambda(\bar{e}) = \begin{cases} 2 \, wt(\bar{e}) , & \text{if } \bar{e} \text{ is of type } N; \\ 2 \, wt(\bar{e}) + (\text{number of edges of } \Gamma_P \text{ incident to the vertex } c_j), & \text{if } \bar{e} \text{ of type } O. \end{cases}$$

By Corollary 7.10 and the fact that (by the parity rule) no  $D$ -edge can have the same label at both endpoints, it is easy to see that, assuming  $n \geq 4$  in Case II, we have  $\lambda(\bar{e}) \leq n$  for every  $D$ -edge  $\bar{e}$  of  $\bar{\Gamma}_P$ .

Let  $k$  be the number of  $D$ -edges of  $\bar{\Gamma}_P$ . If  $k = 0$ , then  $5n \leq 4$  in Case I, and  $5n \leq 8$  in Case II, both contradictions. So we assume  $k \geq 1$ . Also, if  $n = 1$  then  $k = 0$ , so we also assume  $n > 1$ . Let  $k_0$  be the number of  $D$ -edges of  $\bar{\Gamma}_P$  of type  $O$ . It is easy to see that  $k \leq 5$  and  $k - 1 \leq k_0 \leq 4$ . Note that there are  $(4 - k_0)$  vertices  $c_j$  that are not associated with  $D$ -edges of type  $O$ . It follows that

$$5n \leq \Delta n \leq kn + \begin{cases} (4 - k_0) , & \text{in Case I;} \\ 2(4 - k_0) , & \text{in Case II, if } n \geq 4 \end{cases}$$

**Lemma 7.12.** *Case I is impossible.*

*Proof.* We have  $5n \leq kn + (4 - k_0) \leq kn + (4 - (k - 1))$ , and hence  $5(n - 1) \leq k(n - 1)$ . Since  $n > 1$ , this implies that  $k = 5$  and  $k_0 = 4$ . Thus  $\bar{\Gamma}_P$  has four  $D$ -edges of type  $O$  and one of type  $N$ .

Now if  $\bar{e}$  is of type  $N$  then

$$\lambda(\bar{e}) \leq \begin{cases} n, & n \text{ even;} \\ n-1, & n \text{ odd;} \end{cases}$$

and if  $\bar{e}$  is of type  $O$  then (since each  $c_j$  has valency 1)

$$\lambda(\bar{e}) \leq \begin{cases} n-1, & n \text{ even;} \\ n, & n \text{ odd.} \end{cases}$$

Thus we get  $5(n-1) < 5(n-1)$ , a contradiction.  $\diamond$

**Lemma 7.13.** *In Case II,  $n = 2$ .*

*Proof.* Assume  $n \geq 4$ . We have  $5n \leq kn+2(4-k_0) \leq kn+2(4-(k-1))$ , giving  $(5-k)n \leq 2(5-k)$ . This is a contradiction unless  $\Delta = k = 5$  and  $\lambda(\bar{e}) = n$  for each of the five  $D$ -edges of  $\bar{\Gamma}_P$ . The  $D$ -edges of  $\bar{\Gamma}_P$  are as shown in Figure 5. (Each  $c_j$  has valency 0 or 2 in  $\Gamma_P$ ; the  $CD$ -edges of  $\bar{\Gamma}_P$  are not shown in Figure 5.) Corresponding to the faces  $\bar{f}_1, \bar{f}_2$  of  $\bar{\Gamma}_P$  shown in Figure 5 are 3-gon  $D$ -edge faces  $f_1, f_2$  of  $\Gamma_P$ . Since  $\lambda(\bar{e}) = n$  for each  $D$ -edge  $\bar{e}$  of  $\bar{\Gamma}_P$ ,  $f_1$  and  $f_2$  are Scharlemann cycles of order 3.

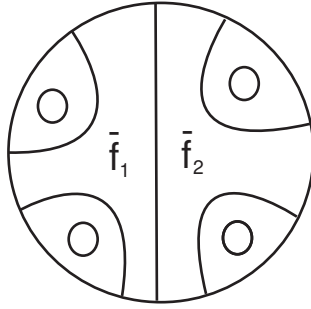

FIGURE 5.

If  $n \equiv 2 \pmod{4}$  then  $f_1$  (say)  $\subset X_1$  and  $f_2 \subset X_2$ . Hence each of the two exceptional fibres of  $L(p, q)$  has multiplicity 3. But this contradicts Lemma 7.6(2).

If  $n \equiv 0 \pmod{4}$  then  $f_1$  and  $f_2$  both lie in  $X_1$ , say. Since the label-pairs at the corners of  $f_1$  and  $f_2$  are distinct, this contradicts Lemma 7.11.  $\diamond$

From now on we will assume that we are in Case II and  $n = 2$ . Note that there are no parallel  $D$ -edges in  $\Gamma_P$  by Corollary 7.10.

Since all the  $c_j$ 's have the same sign, and  $a_1, a_2$  (resp.  $b_1, b_2$ ) have opposite signs, we may assume that  $a_1, a_2$  and  $b_1, b_2$  are numbered so that any  $AB$ -edge of  $\Gamma_Q$  joins  $a_i$  to  $b_i$ ,  $i = 1$  or  $2$ ; equivalently, every  $CD$ -edge of  $\Gamma_P$  has the same label (1 or 2) at both its endpoints.

Let  $f$  be a face of  $\Gamma_P$ . Then  $\partial f$  consists of edges of  $\Gamma_P$  together with *corners* at the vertices, i.e. subarcs of the corresponding boundary components of  $P$ . We call a corner at the vertex  $d_V$  a  $d_V$ -corner, and a corner at a vertex  $c_j$  a  $c$ -corner.

**Lemma 7.14.** *Suppose  $\Gamma_P$  has a disk face with at least two  $d_V$ -corners, contained in  $X_i$ . Then  $X_i$  is a solid torus.*

*Proof.* Suppose  $X_i$  is not a solid torus; then  $X_i \cong T^2 \times I$ . Let  $T_i, T'_i$  be the boundary components of  $X_i$ , where  $A \subset T_i$ . Let  $f$  be a disk face of  $\Gamma_P$  as in the statement of the lemma. Let  $H_i = (\overline{L(p, q) - V}) \cap X_i$ , and define  $W = N(T_i \cup H_i \cup f)$ . Then  $\partial W = T_i \cup T'_i$ , say. Let  $E$  be a disk in  $A$  containing  $H_i \cap A$  and let  $x \in H_1(W, E) \cong H_1(W)$  be the class of the core of the 1-handle  $H_i$ . Then  $H_1(W) \cong (H_1(T_i) \oplus \mathbb{Z})/([\partial f])$ , where  $\mathbb{Z}$  is generated by  $x$ . If  $f$  has  $m \geq 2$   $d_V$ -corners then  $[\partial f] = (y, mx)$  for some  $y \in H_1(T_i)$ . Therefore  $H_1(W, T_i) \cong \mathbb{Z}/m$ . But this contradicts the fact that, since  $T'_i$  is homologous to  $T_i$  in  $X_i \cong T^2 \times I$ ,  $W \cong T^2 \times I$ .  $\diamond$

Let  $f$  be a face of  $\Gamma_P$ . We say  $f$  is of type  $(a, b)$  if  $f$  is a disk and has  $a$   $d_V$ -corners and  $b$   $c$ -corners.

**Lemma 7.15.**  *$\Gamma_P$  does not have faces of types  $(a, b)$  and  $(c, d)$ , where  $c \geq 2$  and  $ad - bc = \pm 1$ , that both lie in the same  $X_i$ .*

*Proof.* Let  $f, g$  be faces of type  $(a, b), (c, d)$ , respectively, lying in  $X_i$ . The existence of  $g$  implies that  $X_i$  is a solid torus by Lemma 7.14.

Let  $A_i$  be the annulus  $\overline{\partial X_i - A}$ . Then  $H_1(X_i, A)$  is generated by  $t$ , where  $t$  is represented by a cocore arc of  $A_i$  running from  $a_2$  to  $a_1$ . Also,  $H_1(X_i, A) \cong \mathbb{Z}/m$ , where  $m$  is the multiplicity of the exceptional fibre that is the core of  $X_i$ . Let  $H_i = (\overline{L(p, q) - V}) \cap X_i$ , and  $\partial_0 H_i = \partial H_i \cap T_V$ . The boundary of the face  $f$ , as it lies in  $X_i$ , consists of  $a$  cocore arcs of the annulus  $\partial_0 H_i$  (coming from the  $d_V$ -corners of  $f$ ),  $b$  cocore arcs of the annulus  $A_i$ , (coming from the  $c$ -corners of  $f$ ), together with edges of  $\Gamma_Q$ , lying in  $A$ ; similarly for  $g$ . Let  $x$  be the element of  $H_1(X_i, A)$  represented by the core of the 1-handle  $H_i$ , oriented from  $b_1$  to  $b_2$ . Then  $f$  and  $g$  give the relations

$$ax + bt = 0$$

$$cx + dt = 0$$

in  $H_1(X_i, A)$ . Since  $ad - bc = \pm 1$ , this implies that  $t = 0$  and therefore  $H_1(X_i, A) = 0$ , a contradiction.  $\diamond$

**Corollary 7.16.**  *$\Gamma_P$  does not have a pair of faces of the following types lying in  $X_i$ :*

- (1)  $(1, 1)$  and  $(2, 1)$ ;
- (2)  $(1, 1)$  and  $(3, 2)$ ;
- (3)  $(2, 1)$  and  $(3, 2)$ .

**Lemma 7.17.** *In  $\Gamma_Q$ , the endpoints of the  $AB$ -edges incident to  $b_i$  are consecutive around  $b_i$ ,  $i = 1, 2$ .*

*Proof.* This follows immediately from the fact that all the  $AB$ -edges incident to  $b_i$  have their other endpoint on  $a_i$ ,  $i = 1, 2$ .  $\diamond$



We will use Lemma 7.17 in conjunction with the following observation. For  $i = 1$  or  $2$ , consider the edge-endpoints labeled  $i$  around  $d_V$  in  $\Gamma_P$ . In  $\Gamma_Q$  these correspond to the edge-endpoints around vertex  $b_i$ . Number these  $p_0, p_1, \dots, p_{\Delta-1}$  in order around  $b_i$ . Then around  $d_V$  the corresponding points with label  $i$  occur in the order  $p_0, p_d, \dots, p_{(\Delta-1)d}$ , for some integer  $d$  coprime to  $\Delta$ . In particular, if  $\Delta = 6$  then  $d = \pm 1$ . Since  $AB$ -edges in  $\Gamma_Q$  correspond to  $CD$ -edges in  $\Gamma_P$  we have the following corollary to Lemma 7.17.

**Corollary 7.18.** *If  $\Delta = 6$  then the endpoints with label  $i$  on  $d_V$  of the  $CD$ -edges of  $\Gamma_P$  are consecutive among all the edge-endpoints with label  $i$  on  $d_V$ ,  $i = 1, 2$ .*

**Lemma 7.19.** *Case II,  $n = 2$ , is impossible.*

*Proof.* Let  $k$  be the number of  $D$ -edges of  $\Gamma_P$ , and  $\ell$  the number of vertices  $c_j$  with valency 2. Thus  $1 \leq k \leq 5$  and  $\ell = 3$  or  $4$ .

$k = 5$ . The  $D$ -edges of  $\Gamma_P$  are as shown in Figure 6. Then each of  $X_1$  and  $X_2$  contains a  $D$ -edge Scharlemann cycle of order 3. By Lemma 7.9  $L(p, q)$  has two exceptional fibres of multiplicity 3. This contradicts Lemma 7.6(2).

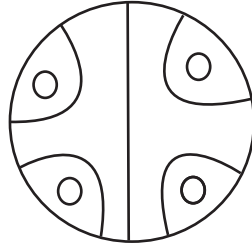

FIGURE 6.

$k = 4$ . There are two cases, (a) and (b), where the  $D$ -edges of  $\Gamma_P$  are as shown in Figure 7(a) and (b), respectively.

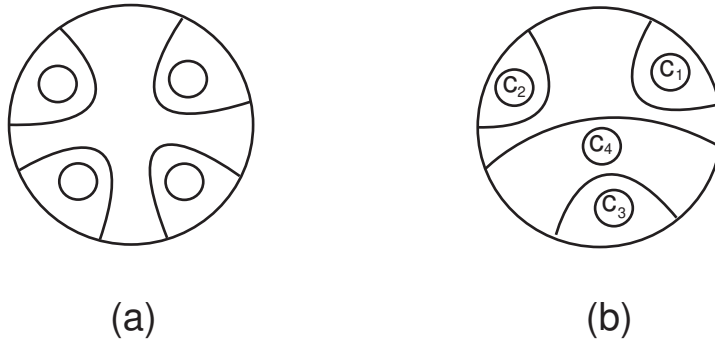

FIGURE 7.

**Case (a).** A vertex  $c_j$  of valency 2 gives rise to a face of type  $(2, 1)$ . It follows from Lemma 7.14 that  $\ell = 4$ , and hence  $\Gamma_P$  is as shown in Figure 8. In particular  $\Delta = 8$ . Let the edge-endpoints

around vertex  $b_1$  in  $\Gamma_Q$  be  $p_0, p_1, \dots, p_7$ , numbered in order around the vertex. By Lemma 7.17 we may assume that  $p_0, p_1, p_2, p_3$  are endpoints of  $AB$ -edges and  $p_4, p_5, p_6, p_7$  endpoints of  $B$ -edges. By the remarks after Lemma 7.17 the corresponding points with label 1 on  $d_V$  in  $\Gamma_P$  appear in the order  $p_0, p_d, \dots, p_{7d}$  for some  $d$  coprime to 8. Since we see from Figure 4 that the  $CD$ -edges and  $D$ -edges with label 1 alternate around  $d_V$  it is clear that no such integer  $d$  exists.

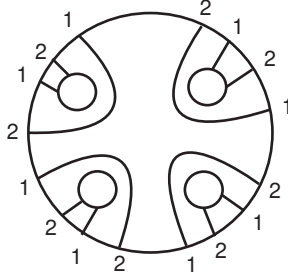

FIGURE 8.

**Case (b).** First note that at least one of  $c_1, c_2$  has valency 2, and hence both do by Lemma 7.14. Similarly, Lemma 7.14 implies that  $c_4$  has valency 2. There are two possibilities for the edges incident to  $c_4$ , shown in Figure 9(i) and (ii).

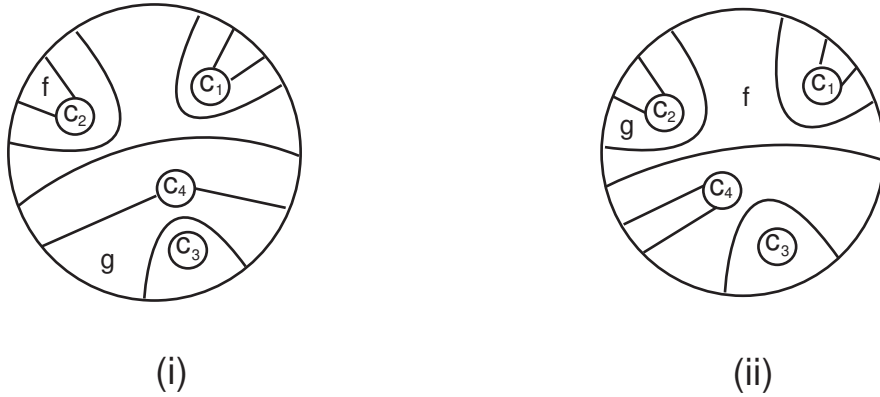

FIGURE 9.

In (i) the faces  $f$  and  $g$  contradict Corollary 7.16(1).

In (ii), the face  $f$  implies, by Lemma 7.14, that  $c_3$  has valency 2. Hence there is a face of type (1,1) on the same side as the face  $g$ , contradicting Corollary 7.16(1). (Here, and in the sequel, by “on the same side” we shall mean on the same side of  $A$  in  $X$ , i.e. in the same component  $X_1$  or  $X_2$ .)

$k = 3$ . There are three cases, (a), (b) and (c), where the  $D$ -edges of  $\Gamma_P$  are as shown in Figure 10(a), (b) and (c), respectively.

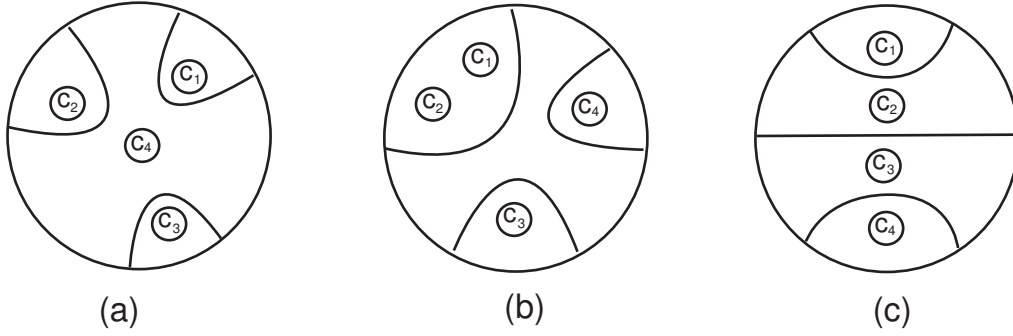

FIGURE 10.

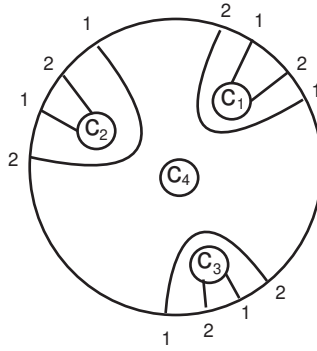

FIGURE 11.

**Case (a).** If  $c_4$  has valency 0 then  $\Gamma_P$  is as shown in Figure 11. Hence  $\Delta = 6$ . Since the 1-labels on  $d_V$  belonging to  $CD$ -edges are not consecutive around  $d_V$ , this contradicts Corollary 7.18.

So suppose  $c_4$  has valency 2. The two possibilities for the edges incident to  $c_4$  are shown in Figure 12(i) and (ii).

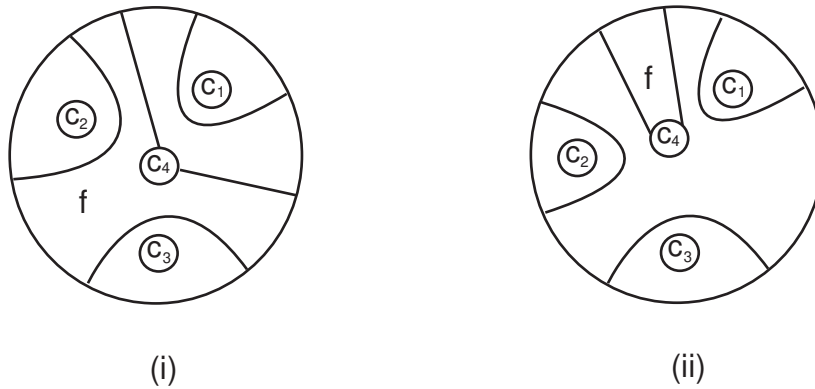

FIGURE 12.

In (i), the face  $f$  implies that  $c_1$  has valency 2, by Lemma 7.14. Hence there is a face  $g$  of type (2,1) on the same side as  $f$ . Also, at least one of  $c_2, c_3$  has valency 2; this gives a face of type (1,1) on the same side as  $g$ , contradicting Corollary 7.16(1).

In subcase (ii), since some  $c_j$ ,  $j = 1, 2, 3$ , has valency 2, we get a face of type (2,1) on the same side as  $f$ , contradicting Corollary 7.16(1).

**Case (b).** At least one of  $c_3, c_4$  has valency 2, and hence all the  $c_j$ 's have valency 2 by Lemma 7.14. The four possibilities for  $\Gamma_P$  are shown in Figure 13(i), (ii), (iii) and (iv).

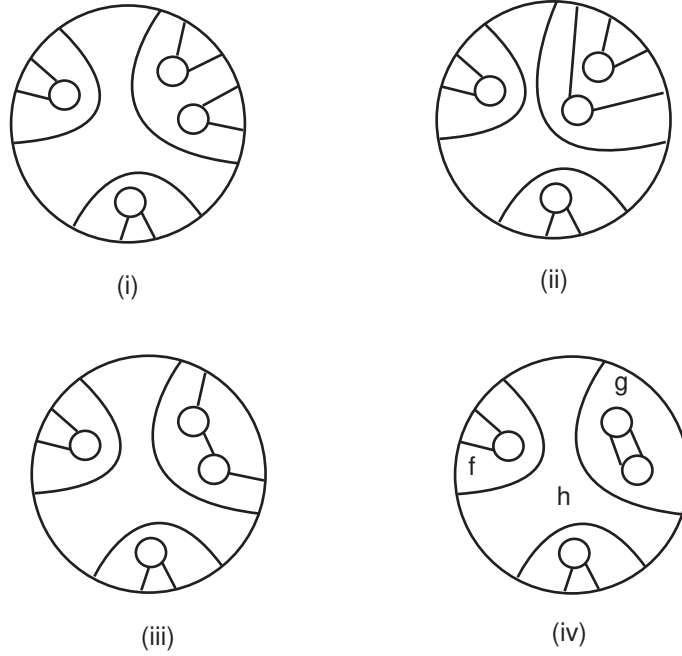

FIGURE 13.

(i) contradicts Corollary 7.16(3), and (ii) contradicts Corollary 7.16(1).

In (iii),  $\Delta = 6$  and the labeling around  $d_V$  contradicts Corollary 7.18.

In (iv), suppose the face  $f$  lies in  $X_1$ . Then  $X_1$  is a solid torus by Lemma 7.14, and  $f$  gives the relation  $2x + t = 0$  in  $H_1(X_1, A)$ . (See the proof of Lemma 7.15 for notation.) The annulus face  $g$  also lies in  $X_1$  and gives the relation  $x + 2t = 0$ . These relations give  $3t = 0$ , and hence  $H_1(X_1, A) \cong \mathbb{Z}/3$ . This implies that the core of  $X_1$  is an exceptional fibre of multiplicity 3. The  $D$ -edge Scharlemann cycle  $h$  implies that the core of  $X_2$  is also an exceptional fibre of multiplicity 3, by Lemma 7.9. This contradicts Lemma 7.6(2).

Case (c). Since  $\ell \geq 3$ , either  $c_1$  and  $c_2$  both have valency 2, or  $c_3$  and  $c_4$  both have valency 2. Assume the former without loss of generality. The fact that  $c_1$  has valency 2 gives a face  $f$  of type (1,1) and a face  $g$  of type (2,1) on opposite sides. There are two possibilities for the configuration of the  $CD$ -edges incident to  $c_2$ . In one case we get a face of type (1,1) on the same side as  $g$ , and in the other case a face of type (2,1) on the same side as  $f$ . These both contradict Corollary 4.16(1).

$k = 2$ . There are two cases (a) and (b), illustrated in Figure 14(a) and (b).

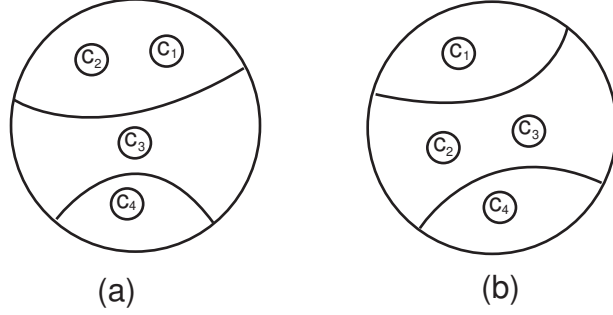

FIGURE 14.

**Case (a).** First suppose that  $c_3$  has valency 0. Then  $c_1, c_2$  and  $c_4$  have valency 2, and since  $\Delta \geq 5$  the edges incident to  $c_1, c_2$  and  $c_4$  are all  $CD$ -edges. This gives faces of type  $(2,1)$  and  $(3,2)$  on the same side, contradicting Corollary 7.16(3).

So suppose  $c_3$  has valency 2. The two possible arrangements of the edges incident to  $c_3$  are shown in Figure 15(i) and (ii).

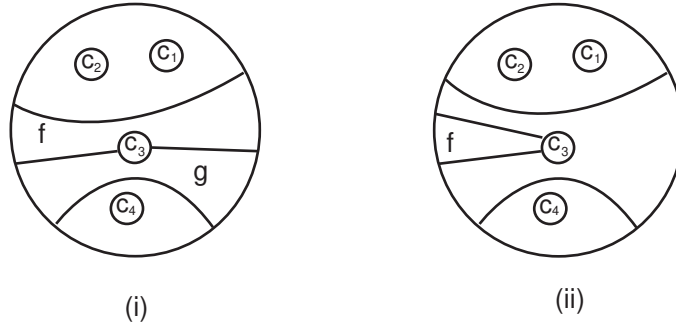

FIGURE 15.

In (i), the face  $f$ , together with Lemma 7.14, implies that  $c_4$  has valency 2. This gives a face of type  $(1,1)$  on the same side as  $g$ , contradicting Corollary 7.16(1).

In subcase (ii), if  $c_4$  has valency 2 then we get a face of type  $(2,1)$  on the same side as  $f$ , contradicting Corollary 7.16(1). If  $c_4$  has valency 0 then  $c_1$  and  $c_2$  have valency 2, and since  $\Delta \geq 5$  the edges incident to  $c_1$  and  $c_2$  are  $CD$ -edges. The resulting face of type  $(3,2)$  contradicts Lemma 7.14.

**Case (b).** First suppose that one of  $c_2, c_3$  has valency 0. Note that since  $\Delta \geq 5$   $\Gamma_P$  has no  $C$ -edges. Therefore there are three possibilities for  $\Gamma_P$ , illustrated in Figure 16(i), (ii) and (iii).

In (i) the faces  $f$  and  $g$  contradict Corollary 7.16(1).

In (ii) and (iii) the faces  $f$  and  $g$  contradict Lemma 7.14.

So suppose that both  $c_2$  and  $c_3$  have valency 2. Since  $\Delta \geq 5$  there cannot be two  $C$ -edges joining  $c_2$  and  $c_3$ . There are therefore seven possibilities for the edges incident to  $c_2$  and  $c_3$ , shown in Figure 17(i)–(vii).

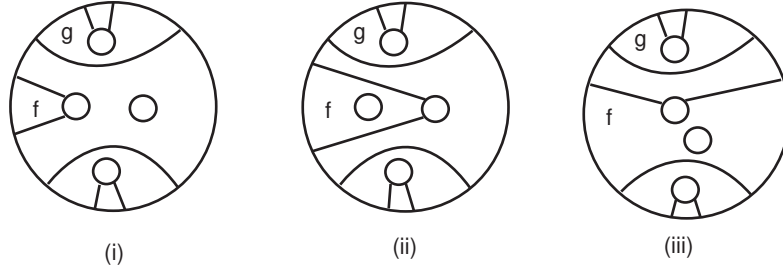

FIGURE 16.

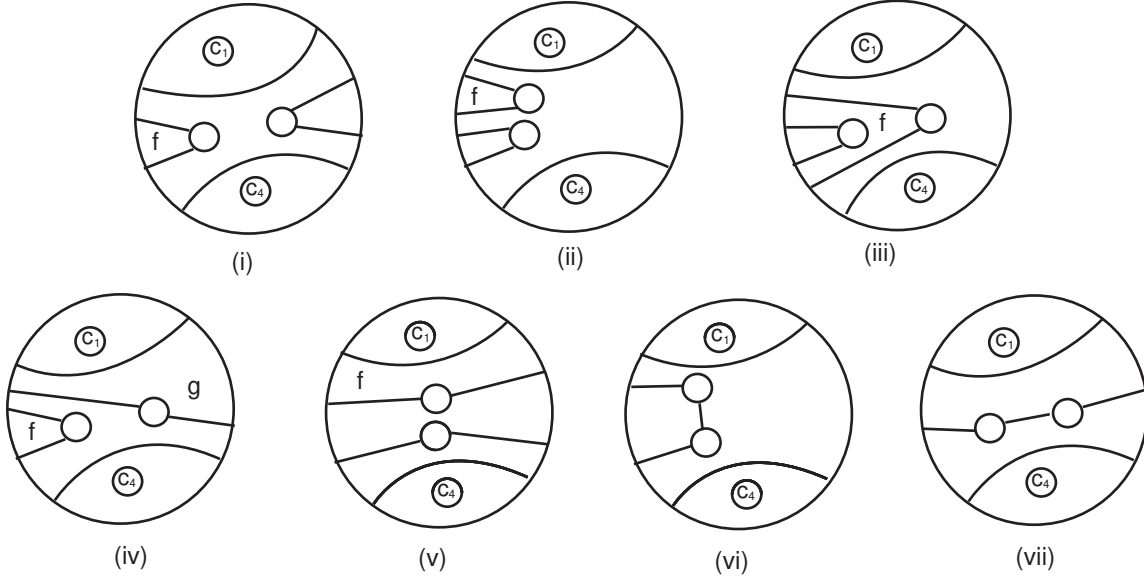

FIGURE 17.

In (i) and (ii), at least one of  $c_1$  and  $c_4$  has valency 2. This gives a face of type (2,1) on the same side as  $f$ , contradicting Corollary 7.16(1).

In (iii), the face  $f$  implies, by Lemma 7.14, that both  $c_1$  and  $c_4$  have valency 2. Hence  $\Gamma_P$  is as illustrated in Figure 18. In particular  $\Delta = 6$ . But the 1-labels on  $d_V$  of the  $CD$ -edges are not consecutive on  $d_V$ , contradicting Corollary 7.18.

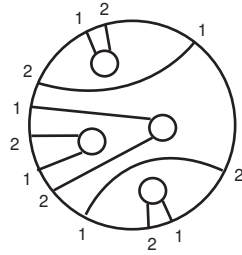

FIGURE 18.

In (iv), the faces  $f$  and  $g$  contradict Corollary 7.16(1).

In (v), at least one of  $c_1$  and  $c_4$  has valency 2, giving a face of type (1,1) on the same side as  $f$ . This contradicts Corollary 7.16(1).

In (vi) and (vii) we must have  $\ell = 4$  since  $\Delta \geq 5$ . Then in (vi) we get faces of type (1,1) and (3,2) on the same side, and in (vii) faces of type (1,1) and (2,1) on the same side, contradicting Corollary 7.16(2) and (1) respectively.

$k = 1$ . The two possibilities for the  $D$ -edge of  $\Gamma_P$  are shown in Figure 19 (a) and (b). Note that since  $\Delta \geq 5$ ,  $\Gamma_P$  has no  $C$ -edges and  $\ell = 4$ .

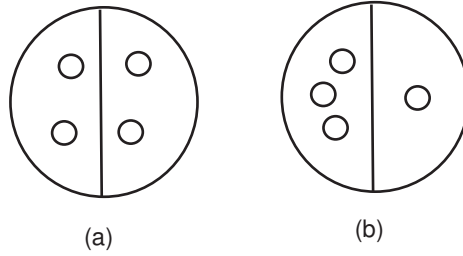

FIGURE 19.

**Case (a).** Either  $\Gamma_P$  is as shown in Figure 20(i), or the  $CD$ -edges on one side of the  $D$ -edge are as shown in Figure 20(ii).

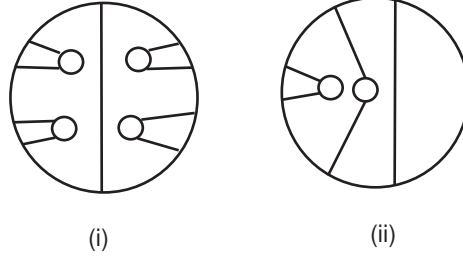

FIGURE 20.

In (i) we have faces of type (1,1) and (3,2) on the same side, contradicting Corollary 7.16(2).

In (ii) we have faces of type (1,1) and (2,1) on the same side, contradicting Corollary 7.16(1).

**Case (b).** It is easy to see that for all possible configurations of the  $CD$ -edges we get faces of type (1,1) and (2,1) on the same side, contradicting Corollary 7.16(1).

This completes the proof of Lemma 7.19.  $\diamond$

The not very small case of Proposition 7.1 now follows from Lemmas 7.12, 7.13 and 7.19.  $\diamond$

## 8. THE PROOF OF THEOREM 1.2 WHEN $F$ IS A FIBRE

In this section we prove the fibre case of Theorem 1.2.

**Proposition 8.1.** *Suppose that  $M$  is a hyperbolic knot manifold which contains an essential twice-punctured torus  $F$  of boundary slope  $\beta$  and let  $\alpha$  be a slope on  $\partial M$  such that  $M(\alpha)$  is an irreducible small Seifert manifold. If  $F$  is a fibre in  $M$ , then  $\Delta(\alpha, \beta) \leq 3$ .*

Recall the involution  $\tau_F$  depicted in Figure 2 and let  $\tau$  be its fibre-by-fibre extension to  $M$ . Then  $M/\tau = (V, L)$  where  $V$  is a solid torus and  $L$  is a 4-braid. The reader will verify that there is curve representing a dual class  $\beta^*$  to  $\beta$  on  $\partial M$  on which  $\tau$  acts by rotation by  $\pi$ . Write

$$(8.0.1) \quad \alpha = p\beta^* + q\beta$$

where  $p, q$  are coprime. After possibly changing the signs of  $\beta^*$  and  $\beta$  we may assume that

$$(8.0.2) \quad p = \Delta(\alpha, \beta)$$

Note that  $\beta$  is sent to the meridian slope  $\bar{\beta}$  on  $\partial V$ , so  $V(\bar{\beta}) \cong S^1 \times S^2$ , while  $\beta^*$  is sent to  $2\bar{\beta}^*$  where  $\bar{\beta}^*$  is a longitude of  $V$ .

For each slope  $\gamma$  on  $\partial M$ ,  $\tau$  extends to an involution  $\tau_\gamma : M(\gamma) \rightarrow M(\gamma)$ . Moreover, if  $\tilde{U}_\gamma$  denotes the filling torus in  $M(\gamma)$  and  $\tilde{K}_\gamma$  its core, then

$$(8.0.3) \quad \text{Fix}(\tau_\gamma) = \begin{cases} \tilde{L} & \text{if } \Delta(\gamma, \beta^*) \text{ is odd} \\ \tilde{L} \cup \tilde{K}_\gamma & \text{if } \Delta(\gamma, \beta^*) \text{ is even} \end{cases}$$

It is clear that  $\tilde{U}_\gamma/\tau_\gamma$  is a solid torus  $U_\gamma$ . Denote its core  $\tilde{K}_\gamma/\tau_\gamma$  by  $K_\gamma$ . Thus  $M(\gamma)/\tau_\gamma = V \cup_{\tilde{\gamma}} U_\gamma$  is a lens space. Indeed, if  $\gamma = r\beta^* + s\beta$ , then under the double cover  $\partial M \rightarrow \partial V$  we have  $\gamma \mapsto 2r\bar{\beta}^* + s\bar{\beta}$ . Let  $\bar{\gamma} = \frac{1}{\gcd(2,s)}(2r\bar{\beta}^* + s\bar{\beta})$  denote the associated slope and  $L_\gamma$  the branch set in  $M(\gamma)/\tau_\gamma$ . Then

$$(M(\gamma)/\tau_\gamma, L_\gamma) = (V(\bar{\gamma}), L_\gamma) \cong \begin{cases} (L(2r, s), L) & \text{if } s \text{ is odd} \\ (L(r, \frac{s}{2}), L \cup K_\gamma) & \text{if } s \text{ is even} \end{cases}$$

We are interested in the case  $\gamma = \alpha$ . Set

$$(8.0.4) \quad \bar{p} = \frac{2p}{\gcd(2, q)} \quad \text{and} \quad \bar{q} = \frac{q}{\gcd(2, q)}$$

so that  $\bar{\alpha} = \bar{p}\bar{\beta}^* + \bar{q}\bar{\beta}$  and

$$M(\alpha)/\tau_\alpha \cong L(\bar{p}, \bar{q})$$

From 8.0.3 we see that

$$(8.0.5) \quad |L_\alpha| = \begin{cases} |L| & \text{if } q \text{ is odd} \\ |L| + 1 & \text{if } q \text{ is even} \end{cases}$$

By [BGZ3, Lemma 4.1] there is a  $\tau_\alpha$ -invariant Seifert structure of  $M(\alpha)$  with base orbifold of the form  $S^2(a, b, c)$  where  $a, b, c \geq 1$ . Let  $\bar{\tau}_\alpha$  be the induced map on  $S^2(a, b, c)$ .

We begin with the case where  $M(\alpha)$  is a lens space.

**Lemma 8.2.** *Suppose that  $M$  is a hyperbolic knot manifold which contains an essential twice-punctured torus  $F$  of boundary slope  $\beta$  and let  $\alpha$  be a slope on  $\partial M$  such that  $M(\alpha)$  is an irreducible small Seifert manifold. If  $F$  is a fibre in  $M$  and  $M(\alpha)$  is a lens space, then  $\Delta(\alpha, \beta) \leq 3$ .*



**Proof.** By [L3]  $\Delta(\alpha, \beta) \leq 4$  so we suppose that  $p = \Delta(\alpha, \beta) = 4$  in order to derive a contradiction. In this case  $q$  is odd, so that  $L_\alpha = L$  (8.0.5). Further,  $\bar{p} = 8$  and  $\bar{q} = q$  so  $M(\alpha)/\tau_\alpha \cong L(8, q)$ . By [BGZ3, Lemma 4.2],  $L_\alpha$  is either

- the union of the cores of the two Heegaard solid tori of  $L(8, q)$ ; or
- the boundary of an annular spine of a Heegaard solid torus of  $L(8, q)$ .

It follows that each component of  $L_\alpha$  carries a generator of  $H_1(L(8, q))$ . On the other hand,  $L_\alpha$  is isotopic in  $L(8, q)$  to the 4-braid  $L$  in  $V$  so  $L$  must split into a 1-braid  $L_0$  and a 3-braid  $L_1$ . Since the generators of  $H_1(L(8, q))$  have order 8,  $L_0$  and  $L_1$  carry different generators and so  $L_\alpha$  must be the union of the cores of the two Heegaard solid tori of  $L(8, q)$ .

**Claim 1.** Let  $Y_1$  be the exterior  $L_1$  in  $V$ . Then  $Y_1$  is Seifert fibred.

The Dehn filling of  $Y_1$  along  $\partial V$  with the slope  $\bar{\alpha}$  is a manifold homeomorphic to the exterior of  $L_1$  in  $L(8, q)$  and thus is a solid torus. On the other hand the Dehn filling of  $Y_1$  along  $\partial V$  with the slope  $\bar{\beta}$  is a manifold homeomorphic the exterior of  $L_1$  in  $S^2 \times S^1$  and thus is a twice-punctured disk bundle and therefore Seifert fibred. Since  $\Delta(\bar{\alpha}, \bar{\beta}) = 8 > 5$ ,  $Y_1$  cannot be hyperbolic by [Go1, Theorem 1.3]. Since  $Y_1$  is the exterior of a single component closed 3-braid in  $V$ , the monodromy of the corresponding thrice-punctured disk bundle structure of  $Y_1$  cannot be reducible. So it is periodic and  $Y_1$  is Seifert fibred.

**Claim 2.** Let  $Y$  be the exterior of  $L = L_0 \cup L_1$  in  $V$ . Then  $Y$  is hyperbolic.

To prove this claim, suppose for contradiction that  $Y$  is non-hyperbolic. It is irreducible, since  $L_0$  and  $L_1$  are each homotopically essential in  $V$ . Thus  $Y$  is either Seifert fibred or contains an essential torus. In the latter case, the monodromy of  $Y$  with respect to the 4-punctured disk bundle structure is reducible and its invariant essential curve in a 4-punctured disk fiber can only be a circle which encloses the three punctures coming from  $L_1$  but not the puncture from  $L_0$ . Hence the corresponding essential torus  $T$  separates  $Y$  into a thrice-punctured disk bundle  $Y_1$  and a once-punctured annulus bundle  $Y_0$ . Obviously  $Y_0$  is Seifert fibred and  $Y_1$  is homeomorphic to the exterior of  $L_1$  in  $V$ , which is Seifert fibred by Claim 1. Therefore  $Y$  has no hyperbolic pieces in its JSJ torus decomposition. Now the exterior of  $\tilde{L}$  in  $M$  is a free double cover of  $Y$  and thus has no hyperbolic pieces in its JSJ torus decomposition. Thus  $M$  cannot be hyperbolic, giving a contradiction.

To finish the proof of the lemma, we adopt an intersection graph argument as in §7.2. In the present case the argument is much simpler due to the relatively large distance of 8 between the slopes  $\bar{\alpha}$  and  $\bar{\beta}$  on  $\partial V$ .

Let  $T_i$  be the torus boundary of  $Y$  corresponding to  $L_i$ ,  $i = 0, 1$ . Then  $\partial Y = T_0 \cup T_1 \cup \partial V$ . The  $\bar{\alpha}$ -filling of  $Y$  along  $\partial V$  is the exterior of  $L$  in  $L(8, q)$  and thus is homeomorphic to  $T^2 \times [0, 1]$  (recall that  $L_0$  and  $L_1$  are cores of the two Heegaard solid tori of  $L(8, q)$ ). Let  $A$  be a properly embedded essential annulus in this manifold whose boundary component  $a_1$  on  $T_1$  is a meridional slope of  $L_1$ . Then the other boundary component  $a_0$  of  $A$  on  $T_0$  is a slope distance 8 from the meridional slope of  $L_0$ . Now isotope  $A$  fixing  $\partial A$  so that  $A \cap \partial V$  has minimal number of components and let  $Q = Y \cap A$ . Then  $Q$  is an essential  $n$ -punctured annulus in  $Y$ . Since  $Y$

is hyperbolic,  $n > 0$ . Let  $b_1, \dots, b_n$  be the components of  $\partial Q$  which lie on  $\partial V$  and they are indexed in the order they appear along  $\partial V$ . Note that  $b_1, \dots, b_n$  are parallel circles in  $\partial V$  with the slope  $\bar{\alpha}$ .

Let  $P$  be a fixed 4-punctured disk fiber in  $Y$ . Then  $P$  is essential in  $Y$ . Denote the components of  $\partial P$  by  $d, c_0, c_1, c_2, c_3$ , where  $d$  lies on  $\partial V$  and has slope  $\bar{\beta}$ ,  $c_0$  lies on  $T_0$  and has the meridional slope of  $L_0$ , and  $c_1, c_2, c_3$  lie on  $T_1$  and each has the meridional slope of  $L_1$ .

Isotope  $Q$  and  $P$  to intersect transversely and minimally, and consider their intersection graphs  $\Gamma_Q, \Gamma_P$  with vertices  $a_0, a_1, b_1, \dots, b_n$  and  $d, c_0, c_1, c_2, c_3$  respectively, and with the arc components of  $Q \cap P$  as edges. Since  $a_1$  and  $c_1, c_2, c_3$  are meridians of  $L_1$  on  $T_1$ , they are disjoint and thus have valency 0. By construction  $a_0$  and  $c_0$  have valency 8,  $d$  has valency  $8n$ , and  $b_1, \dots, b_n$  have valency 8.

The edges of  $\Gamma_Q$  and  $\Gamma_P$  are essential arcs in  $P$  and  $Q$ . By the parity rule, no edge in  $\Gamma_Q$  has both of its endpoints incident to  $a_0$  and thus there are exactly 8 edges in  $\Gamma_Q$  incident to  $a_0$ , each connecting  $a_0$  to some  $b_i$ . Call such edges *ab-edges*. The remaining  $4(n-1)$  edges  $\Gamma_Q$  connect  $b_i$ 's to  $b_i$ 's and we call them *bb-edges*.

Similarly no edge in  $\Gamma_P$  has both of its endpoints incident to  $c_0$  and thus in  $\Gamma_P$  there are exactly 8 *cd-edges* connecting  $c_0$  to  $d$ . The remaining  $4(n-1)$  edges of  $\Gamma_P$  connect  $d$  to  $d$  which are called *dd-edges*.

An edge in one graph is dual to an edge in the other graph if they come from the same arc component of  $P \cap Q$ . Then *ab-edges* are dual to *cd-edges* and *bb-edges* are dual to *dd-edges*. The parity rule shows that each *dd-edge* is a positive edge and each *bb-edge* is negative (i.e. it connects vertices of opposite signs).

As in Lemma 7.8,  $\Gamma_P$  has no Scharlemann cycles consisting of *dd-edges*. It is an elementary fact that if  $\Gamma_P$  has a parallel family of more than  $n/2$  *dd-edges*, then it has a Scharlemann cycle of *dd-edges* (an *S-cycle* to be exact; see [CGLS, Corollary 2.6.7]). Hence each parallel family of *dd-edges* has at most  $n/2$  members. It's easy to see that the reduced graph of  $\Gamma_P$  has at most 5 *dd-edges* (cf. Figure 6). Hence in  $\Gamma_P$  there are at most  $5n/2$  *dd-edges*. On the other hand there are exactly  $4(n-1)$  *dd-edges*. Hence we have  $4(n-1) \leq 5n/2$ , which yields  $n \leq 2$ .

**Claim 3.** If  $e_1$  and  $e_2$  are two parallel *ab-edges* in  $\Gamma_Q$ , then their dual *cd-edges*  $e'_1$  and  $e'_2$  cannot be parallel in  $\Gamma_P$ .

To prove the claim assume, for a contradiction, that  $e'_1$  and  $e'_2$  are parallel in  $\Gamma_P$ . Let  $B$  be the disk region in  $Q$  between  $e_1$  and  $e_2$  and let  $B'$  be the disk region in  $P$  between  $e'_1$  and  $e'_2$ . We may assume that  $e_1$  and  $e_2$  are an innermost such pair, i.e.  $B$  and  $B'$  only intersect in  $Y$  along  $e_1 = e'_1$  and  $e_2 = e'_2$ . (Otherwise there is an edge  $e \neq e_1, e_2$  in  $B$  whose dual edge  $e'$  is contained  $B'$ , and we may replace  $e_2$  by  $e$  and restart the proof.) Then  $B$  and  $B'$  paste together in  $Y$  forming a properly embedded annulus  $E$  in  $Y$  connecting  $\partial V$  and  $T_0$ . We claim that  $E$  is essential in  $Y$ , contrary to Claim 2, thus completing the proof of Claim 3.

Since  $E$  connects different components of  $\partial Y$ , it suffices to show that each component of  $\partial E$  is essential in  $T_0$  or  $\partial V$ . To see this, suppose that  $e_1$  and  $e_2$  are incident at  $b_i$ . Then the four endpoints of  $e_1, e_2$  decompose  $\partial B$  into four arcs:  $e_1, a, e_2, b$ , where  $a$  is a sub-arc of  $a_0$  and  $b$  a sub-arc of  $b_i$ . Similarly the endpoints of  $e'_1, e'_2$  decompose  $\partial B'$  into four arcs:  $e'_1, c', e'_2, d'$ , where  $c'$  is a sub-arc of  $c_0$  and  $d'$  a sub-arc of  $d$ . Since  $a_0$  and  $c_0$  intersect minimally in  $T_0$ , the arcs  $a$  and  $c'$  paste together in  $T_0$  to form a simple essential circle. Likewise  $b$  and  $d'$  paste together in  $\partial V$  to form a simple essential circle. Thus  $E$  is essential, contrary to Claim 2.

**Case  $n = 1$ .**

In this case there are exactly eight edges in  $\Gamma_P$ , all being  $cd$ -edges, and there are exactly eight edges in  $\Gamma_Q$ , all being  $ab$ -edges. It is clear that the eight  $ab$ -edges in  $\Gamma_Q$  are parallel to each other, and it is also evident that there are at least two parallel  $cd$ -edges in  $\Gamma_P$ , contrary to Claim 3. Thus  $n \neq 1$ .

**Case  $n = 2$ .**

In this case there are exactly twelve edges in  $\Gamma_P$ , eight being  $cd$ -edges and four being  $dd$ -edges, and similarly there are exactly twelve edges in  $\Gamma_Q$ , eight being  $ab$ -edges and four being  $bb$ -edges. Since  $n = 2$ , the four  $bb$ -edges all connect  $b_1$  to  $b_2$ . It follows that four of the eight  $ab$ -edges in  $\Gamma_Q$  are incident to  $b_1$  and four are incident to  $b_2$ . Thus the reduced graph of  $\Gamma_Q$  is one of the three cases (1) (2) (3) shown in Figure 21. It follows that there is at least one family of four parallel  $ab$ -edges in  $\Gamma_Q$ , which we denote by  $e_1, e_2, e_3, e_4$ . Their dual edges,  $e'_1, e'_2, e'_3, e'_4$ , are  $cd$ -edges and it is easy to see that as the valency of  $c_0$  in the reduced graph of  $\Gamma_P$  is at most 3, at least two of them are parallel in  $\Gamma_P$ . Again we obtain a contradiction to Claim 3 and this rules out the final possibility that  $n = 2$ .  $\diamond$

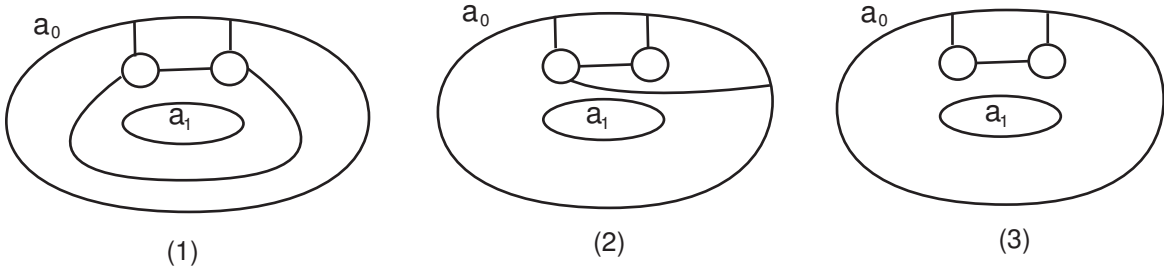

FIGURE 21.

**Lemma 8.3.** *Suppose that  $M$  is a hyperbolic knot manifold which contains an essential twice-punctured torus  $F$  of boundary slope  $\beta$  and let  $\alpha$  be a slope on  $\partial M$  such that  $M(\alpha)$  is an irreducible small Seifert manifold. If  $F$  is a fibre in  $M$ ,  $M(\alpha)$  is not a lens space, and  $\tau_\alpha$  reverses the orientations of the Seifert fibres of  $M(\alpha)$ , then  $\Delta(\alpha, \beta) \leq 3$ .*

**Proof.** Suppose that  $p = \Delta(\alpha, \beta) \geq 3$ . Then  $\bar{p} \geq 3$ , so we can argue as in the proof of [BGZ3, Lemma 4.4] to see that  $M(\alpha)$  has base orbifold  $S^2(\bar{p}, \bar{p}, m)$  where  $m \geq 2$ . Further, there is an integer  $n$  coprime with  $m$  such that  $L_\alpha$  is isotopic to the closure of an  $m/n$  rational tangle in

a genus 1 Heegaard solid torus  $V$  of  $M(\alpha)/\tau_\alpha$  as depicted in Figure 3. We also have  $|L_\alpha| = 1$  if  $n$  is odd and 2 if it is even.

Suppose that  $m$  is even. Then  $L_\alpha$  is connected, so  $L = L_\alpha$  and therefore  $q$  is odd (8.0.5). Further  $L$  is homotopically trivial in  $L(\bar{p}, \bar{q})$ ; in fact,  $L$  is homotopically trivial in the solid torus  $V$  since it is the closure in  $V$  of an  $m/n$ -rational tangle with  $m$  even. But the 4-braid  $L$  represents four times a generator of  $H_1(L(\bar{p}, \bar{q}))$ , so  $2p = \bar{p} > 1$  divides 4, which is impossible since we have assumed  $p \geq 3$ . Thus  $m$  is odd, and so is at least 3.

Considering the universal cover of the lens space  $L(\bar{p}, \bar{q})$ , we obtain two links  $\widehat{L}$  and  $\widehat{L}_\alpha$  in  $S^3$  where  $\widehat{L}$ , the lift of the image of  $L$  in  $L(\bar{p}, \bar{q})$ , is a 4-braid and  $\widehat{L}_\alpha$ , the lift of  $L_\alpha$ , is a Montesinos link with  $\bar{p}$  rational tangles each of type  $m/n$ .

The 2-fold cover  $\Sigma_2(\widehat{L}_\alpha)$  of  $S^3$  branched over  $\widehat{L}_\alpha$  is Seifert with base orbifold a 2-sphere with  $\bar{p}$  cone points, each of order  $m \geq 3$ . Thus the Heegaard genus of  $\Sigma_2(\widehat{L}_\alpha)$  is  $\bar{p} - 1$  [BoiZie]. (Note that any irreducible horizontal Heegaard surface of the Seifert manifold, if one exists, has genus larger than  $\bar{p} - 1$ .)

If  $q$  is odd, then  $L_\alpha = L$ , so  $\widehat{L}_\alpha$  is a closed 4-braid. Since a 2-sphere in  $S^3$  which separates  $(S^3, \widehat{L}_\alpha)$  into two trivial 4-string tangles lifts to a genus 3 Heegaard surface in  $\Sigma_2(\widehat{L}_\alpha)$ , the Heegaard genus of the latter is at most 3. Thus as  $\bar{p} = 2p$  when  $q$  is odd,  $2p - 1 = \bar{p} - 1 \leq 3$ . But then  $\Delta(\alpha, \beta) = p \leq 2$ , contrary to our hypotheses.

Thus  $q$  is even, so  $p$  is odd and  $\bar{p} = p$ . In this case,  $L_\alpha$  is the union of  $L$  and the core of the filling torus in  $L(\bar{p}, \bar{q}) = V(\bar{\alpha})$ . Hence there is a genus 1 Heegaard splitting  $U_1 \cup U_2$  of  $S^3$  such that  $\widehat{L}_\alpha$  is the union of the closed 4-braid  $\widehat{L} \subset U_1$  and the core of  $U_2$ . It follows that  $\widehat{L}_\alpha$  is the closure of a 5-braid in  $S^3$ , so the Heegaard genus of  $\Sigma_2(\widehat{L}_\alpha)$  is at most 4. Hence  $p - 1 = \bar{p} - 1 \leq 4$ , which gives  $p \leq 5$ .

Since  $p \geq 3$  is odd,  $p = 3$  or 5. We will now eliminate the second case.

Assume  $p = 5$ . Then  $L$  is a 4-braid in the Heegaard solid torus  $V \subset L(5, \bar{q}) = V(\bar{\alpha})$ , and  $L_\alpha$  is the union of  $L$  and a core of the complementary solid torus. Also,  $L_\alpha$  is the closure of the  $m/n$ -rational tangle ( $m$  odd,  $n$  even) in some Heegaard solid torus  $W$  in  $L(5, \bar{q})$ , as shown in Figure 3. It follows that each component of  $L_\alpha$  is a core of  $W$ . In particular, the exterior of  $L$  in  $L(5, \bar{q})$  is a solid torus.

Let  $Y$  be the exterior of  $L$  in  $V$ . Then  $\partial Y$  has two components,  $\partial V$  and  $T_L$ , say. A meridian disk  $D$  of  $V$  gives rise to a 4-punctured disk  $P \subset Y$ , with  $\partial P = \partial D \cup c_1 \cup c_2 \cup c_3 \cup c_4$ , where the  $c_j$ 's are meridians of  $L$ . Note that  $\partial D$  has slope  $\bar{\beta}$  on  $\partial V$ . Also, since  $Y(\bar{\alpha})$ , the exterior of  $L$  in  $L(5, \bar{q})$ , is a solid torus, there is an essential disk  $E \subset Y(\bar{\alpha})$  with  $\partial E \subset T_L$ . Choosing  $E$  to have minimal intersection with the core of the filling solid torus in  $Y(\bar{\alpha})$  we get an essential punctured disk  $Q \subset Y$ , with  $\partial Q = \partial E \cup b_1 \cup \dots \cup b_n$ , where the  $b_i$ 's are curves of slope  $\bar{\alpha}$  on  $\partial V$ . Since  $Y$  is hyperbolic,  $n \geq 2$ .

Let  $\varepsilon$  be the slope of  $\partial E$  on  $T_L$ , and let  $\mu$  be the slope on  $T_L$  of a meridian of  $L$ .

**Claim 8.4.**  $\Delta(\varepsilon, \mu) = 5$ .

*Proof of Claim 8.4.* Let  $\lambda, \bar{\gamma}$  be slopes on  $T_L, \partial V$ , respectively, such that  $\Delta(\lambda, \mu) = 1, \Delta(\bar{\gamma}, \bar{\beta}) = 1$ . Then  $H_1(Y) \cong \mathbb{Z} \oplus \mathbb{Z}$ , generated by  $\mu$  and  $\bar{\gamma}$ . Also, in  $H_1(Y)$  we have  $\bar{\beta} = 4\mu$  and  $\lambda = 4\bar{\gamma} + r\mu$  for some  $r \in \mathbb{Z}$ . Write  $\varepsilon = a\lambda + b\mu$ , where  $(a, b) = 1$ . Then  $\varepsilon = a(4\bar{\gamma} + r\mu) + b\mu = 4a\bar{\gamma} + (b + ra)\mu \in H_1(Y)$ . Note that  $\langle \varepsilon \rangle = \ker(H_1(T_L) \rightarrow H_1(Y(\bar{\alpha})))$ . Since  $\bar{\alpha} = 5\bar{\gamma} + \bar{q}\bar{\beta} = 5\bar{\gamma} + 4\bar{q}\mu$ , it follows that there exists  $m \in \mathbb{Z}$  such that

$$\begin{aligned} 4a &= 5m, \quad \text{and} \\ b + ra &= 4\bar{q}m. \end{aligned}$$

The first equation implies  $a = 5c, m = 4c$  for some  $c \in \mathbb{Z}$ , and the second then implies  $b \equiv 0 \pmod{c}$ . Since  $(a, b) = 1, c = \pm 1$ . Hence  $\Delta(\varepsilon, \mu) = |a| = 5$ .  $\diamond$

The intersection of  $P$  and  $Q$  defines in the usual way graphs  $\Gamma_P, \Gamma_Q$  in the 2-sphere, where  $\Gamma_P$  has vertices  $c_1, c_2, c_3, c_4$  and  $d_V$  (corresponding to  $\partial D$ ), and  $\Gamma_Q$  has vertices  $b_1, b_2, \dots, b_n$  and  $e_L$  (corresponding to  $\partial E$ ). Thus in  $\Gamma_P$  the vertex  $d_V$  has valency  $5n$  and each  $c_j$  has valency 5, while in  $\Gamma_Q$  the vertex  $e_L$  has valency 20 and each  $b_i$  has valency 5. Since  $L$  is a braid, all the  $c_j$ 's have the same sign. Hence, by the parity rule,  $\Gamma_P$  has no  $C$ -edges,  $\Gamma_Q$  has no  $E$ -edges, and all  $B$ -edges of  $\Gamma_Q$  are negative.

The computation in the proof of Claim 8.4 shows that  $m = \pm 4$  i.e.  $\varepsilon = \pm 4\bar{\alpha} \in H_1(Y)$ . Thus (with any choice of orientations)

$$\left| \text{number of positive } b_i\text{'s} - \text{number of negative } b_i\text{'s} \right| = 4$$

It follows that  $n$  is even and  $\geq 4$ .

**Claim 8.5.**  $n = 4$ .

**Remark 8.6.** *This is equivalent to saying that  $\Gamma_P$  has no  $D$ -edges.*

*Proof of Claim 8.5.* Suppose  $n \geq 6$ . We use the notation and terminology of the argument immediately preceding Lemma 7.12.

Since each  $c_j$  has valency 5, it is easy to see that if  $\bar{e}$  is an edge of  $\bar{\Gamma}_P$  of type  $O$  then  $\lambda(\bar{e}) \leq n - 1$ . If  $\bar{e}$  is of type  $N$  then  $\lambda(\bar{e}) \leq n$ . Since the valency of  $d_V$  is  $5n$  we get

$$5n \leq k_0(n - 1) + (k - k_0)n + (4 - k_0)5$$

Since  $k - k_0 \leq 1$  this gives

$$(4 - k_0)n \leq 20 - 6k_0,$$

which contradicts our assumption that  $n \geq 6$ .  $\diamond$

**Claim 8.7.**  $L$  is a 1-bridge braid in  $V$ .

*Proof of Claim 8.7.* Recall that in  $\Gamma_P$  all the  $c_j$ 's have the same sign. Claim 8.5 implies that all the  $b_i$ 's have the same sign. Hence  $\Gamma_P$  has only  $CD$ -edges and  $\Gamma_Q$  has only  $BE$ -edges. Therefore there are five parallel  $BE$ -edges in  $\Gamma_Q$ ; see Figure 22. Let  $\gamma \subset \partial V$  be the arc in  $\partial Q$  shown in Figure 22. Then the bigon faces of  $\Gamma_Q$  shown in Figure 22 allow us to define a (non-ambient) isotopy of  $L$  in  $V$  taking it to  $\gamma \cup \delta$ , where  $\delta$  is the image of  $e \cup e'_1$  in  $P \subset D$ , where we treat the

vertex  $c_1$  as a point in  $D$  so that  $\delta$  is considered as a properly embedded arc in  $D$ . See Figure 23 for a typical situation of the arcs  $e_1, e_2, e_3, e_4, e'_1$  in  $P$ . This shows that  $L$  is a 1-bridge braid in  $V$  (with  $\delta$  as the bridge). (Note that since  $Y$  is hyperbolic  $L$  is not a 0-bridge braid.)  $\diamond$

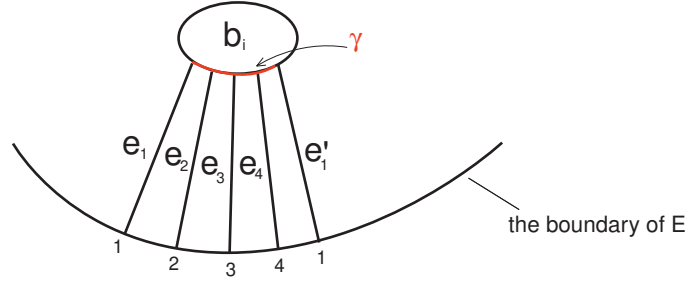

FIGURE 22.

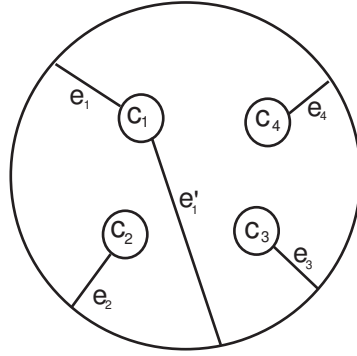

FIGURE 23.

We thus have a 1-bridge  $L$  in  $V$  with a Dehn filling (namely  $\bar{\alpha}$ -filling) on the boundary component  $\partial V$  of the exterior  $Y$  of  $L$  in  $V$  that gives a solid torus. Such braids are classified in [Wu3]. In particular [Wu3, Table 1] shows that there is a unique example (up to homeomorphism) where  $L$  has winding number 4 in  $V$ :  $L$  is the closure of the braid  $\sigma_1(\sigma_3\sigma_2\sigma_1)^2$ . This braid is conjugate to  $\sigma_2\sigma_1\sigma_3\sigma_2\sigma_1^3$ , whose closure is shown in Figure 24. It is clear from this figure that  $L$  bounds a Möbius band in  $V$ , contradicting the fact that  $Y$  is hyperbolic.

This contradiction completes the proof of Lemma 8.3.  $\diamond$

To finish the proof of Proposition 8.1 we only need to prove the following two lemmas.

**Lemma 8.8.** *Suppose that  $M$  is a hyperbolic knot manifold which contains an essential twice-punctured torus  $F$  of boundary slope  $\beta$  and let  $\alpha$  be a slope on  $\partial M$  such that  $M(\alpha)$  is an irreducible small Seifert manifold. If  $F$  is a fibre in  $M$ ,  $M(\alpha)$  is not a lens space, and  $\tau_\alpha$  preserves the orientations of the Seifert fibres of  $M(\alpha)$ , then  $\Delta(\alpha, \beta) \leq 2$  when  $M(\alpha)$  is not a prism manifold.*

**Lemma 8.9.** *Suppose that  $M$  is a hyperbolic knot manifold which contains an essential twice-punctured torus  $F$  of boundary slope  $\beta$  and let  $\alpha$  be a slope on  $\partial M$  such that  $M(\alpha)$  is a prism manifold. If  $F$  is a fibre in  $M$  and  $\tau_\alpha$  preserves the orientations of the Seifert fibres of  $M(\alpha)$ , then  $\Delta(\alpha, \beta) \leq 3$ .*

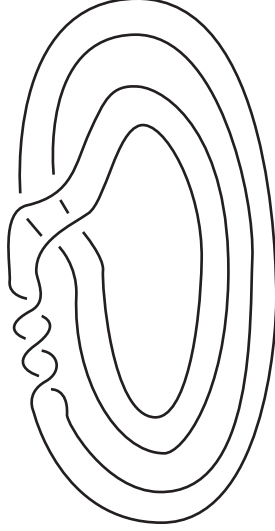

FIGURE 24.

*Proof of Lemma 8.8.* The argument is similar to that given in [BGZ3, §6].

Suppose that  $\Delta = \Delta(\alpha, \beta) \geq 3$ . Then the branch set  $L_\alpha$  is a set of at most three Seifert fibres of  $L(\bar{p}, \bar{q}) = M(\alpha)/\tau_\alpha$  with the induced Seifert fibration from  $M(\alpha)$  given by [BGZ3, Lemma 4.3]. Since  $L$  is a hyperbolic link in  $V$ ,  $K_\alpha$  is not contained in  $L_\alpha$ . Thus  $L_\alpha = L$  so that  $q$  is odd and  $L(\bar{p}, \bar{q})$  is a lens space of order  $2p = 2\Delta \geq 6$ . As in [BGZ3, §6.1], we

- define  $X$  to be the exterior of  $L$  in  $V(\bar{\alpha}) = L(\bar{p}, \bar{q})$  and  $Y$  its exterior in  $V$ ;
- fix a component  $K$  of  $L$  which is a regular fibre of  $L(\bar{p}, \bar{q})$  and define  $T_K$ ; respectively  $T_V$ , to be the component of  $\partial Y$  corresponding to  $K$ , respectively  $\partial V$ ;
- use a meridian disk of  $V$  to construct a 4-punctured disk  $P$  properly embedded in  $Y$ ;
- construct an essential, separating, vertical annulus  $(A, \partial A) \subset (X, T_K)$  which separates  $X$  into two components  $X_1$  and  $X_2$  such that each  $X_i$  is Seifert with base orbifold either an annulus with no cone points or a disk with one cone point, of order at least 3 ([BGZ3, Lemma 6.1]).
- construct an  $n$ -punctured essential annulus  $Q$  in  $Y$ , where  $n$  is even, from an appropriately chosen essential separating vertical annulus in the exterior of  $K$  in  $L(\bar{p}, \bar{q})$ ;
- define graphs  $\Gamma_P$  and  $\Gamma_Q$ , vertices  $d_V, c_1, \dots, c_4, a_1, a_2, b_1, \dots, b_n$ , and  $D$ -edges,  $CD$ -edges, etc.;

In the graph  $\Gamma_P$ ,  $d_V$  has valency  $2\Delta n \geq 6n$ , and each  $c_j$  has valency 0 or 2.

The proof closely follows the proof of Case II of Section 7.

First assume  $n \geq 4$ . The argument immediately preceding Lemma 7.12 then shows that, with the notation established there,

$$\begin{aligned} 2\Delta n &\leq kn + 2(4 - k_0) \\ &\leq kn + 2(5 - k) \end{aligned}$$

giving

$$(2\Delta - k)n \leq 2(5 - k) .$$

Since  $2\Delta \geq 6$ , this is a contradiction.

So we may assume  $n = 2$ . Note that there are no parallel  $D$ -edges in  $\Gamma_P$  and valency  $d_V \geq 12$ . We now follow the proof of Lemma 7.19. By Lemma 7.7(1),  $\ell = 2, 3$  or  $4$ .

$k = 5$ . The  $D$ -edges of  $\Gamma_P$  are as shown in Figure 25. Applying Lemma 7.14, the face  $f$  implies that  $c_3$  and  $c_4$  have valency 2, and similarly the face  $g$  implies that  $c_1$  and  $c_2$  have valency 2. Then  $d_V$  has valency 18, implying that  $\Delta = 9$ , a contradiction.

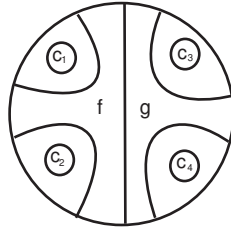

FIGURE 25.

$k = 4$ . The  $D$ -edges of  $\Gamma_P$  are as shown in Figure 7(a) or (b).

In case (a) the proof of Lemma 7.19 applies.

In case (b) the proof of Lemma 7.19 applies unless  $c_1$  and  $c_2$  have valency 0. In this case,  $c_3$  and  $c_4$  have valency 2 and there are two possibilities for  $\Gamma_P$ , shown in Figure 26(i) and (ii). In both cases the faces  $f$  and  $g$  contradict Lemma 7.14.

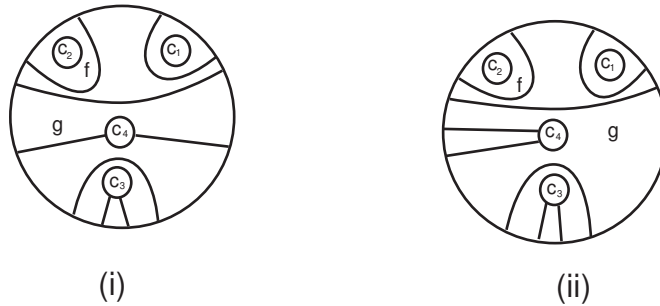

FIGURE 26.

$k = 3$ . Since  $12 \leq \text{valency } d_V = 2k + 2\ell$  we have  $\ell = 3$  or  $4$ . The proof of Lemma 7.19 then applies to rule out every case here except that shown in Figure 13(iv). But in that case  $d_V$  has valency 10.



$k = 2$ . Here  $\ell = 4$ , and the appropriate parts of the proof of Lemma 7.19 apply. More precisely, in case (a) take the part of the proof where  $c_3$  and  $c_4$  have valency 2. In case (b), take the part of the proof that starts with the supposition that both  $c_2$  and  $c_3$  have valency 2. Of the possibilities for  $\Gamma_P$  shown in Figure 17, (vi) and (vii) cannot occur here since valency  $d_V \geq 12$ . The other cases are eliminated as in the proof of Lemma 7.19.

$k = 1$ . Since  $12 \leq \text{valency } d_V = 2k + 2\ell \leq 10$ , this case is impossible.  $\diamond$

*Proof of Lemma 8.9.* Suppose otherwise that  $\Delta = \Delta(\alpha, \beta) \geq 4$ . Then by [L2],  $\Delta = 4$ .

We may assume, by [BGZ3, Lemma 4.1], that the  $\tau_\alpha$ -invariant Seifert structure on  $M(\alpha)$  is the one whose base orbifold is  $S^2(2, 2, c)$  for some  $c \geq 2$ . We continue to use the notations established so far in this section. In the present case we still have the manifolds  $X, T_K, T_V, A, X_1, X_2, Y, P, Q$  and the graphs  $\Gamma_P, \Gamma_Q$  defined as above in this section. The only new situation that possibly arises in the present case (which we assume happens since otherwise the argument of Lemma 8.8 works identically) is that exactly one of  $X_1$  and  $X_2$ , say  $X_1$ , is a solid torus whose singular fibre has order two, and  $X_2$  is either a  $T^2 \times I$  or a solid torus whose singular fibre has order bigger than two. This assertion follows from the proof of [BGZ3, Lemma 6.1]. Thus the graph  $\Gamma_P$  may contain  $D$ -edge  $S$ -cycles, and the proof of Lemma 7.9 yields the following

**Claim 8.10.** *The bigon face bounded by a  $D$ -edge  $S$ -cycle in  $\Gamma_P$  lies on the  $X_1$ -side of  $A$ .*  $\diamond$

**Claim 8.11.** *When  $n \geq 4$ ,  $\Gamma_P$  cannot have  $D$ -edge extended  $S$ -cycles.*

*Proof of Claim 8.11.* Let  $\{e_1, e_2, e_3, e_4\}$  be a  $D$ -edge extended  $S$ -cycle with label sequence  $\{i - 1, i, i + 1, i + 2\}$  (here labels are defined mod  $n$ ). Let  $R_j$  be the bigon face between  $e_j, e_{j+1}$  for  $j = 1, 2, 3$ . Then  $R_2$  is contained in  $X_1$  by Claim 8.10, and  $R_1$  and  $R_3$  in  $X_2$ . Let  $H_j$  be the component of  $V_{\bar{\alpha}} \setminus \cup_{k=1}^n \widehat{b}_k$  connecting  $\{\widehat{b}_j, \widehat{b}_{j+1}\}$  for  $j = i - 1, i, i + 1$ . Let  $U_1$  be a regular neighbourhood of  $H_i \cup R_2$  in  $X_1$ , and  $U_2$  a regular neighbourhood of  $H_{i-1} \cup H_{i+1} \cup R_1 \cup R_3$  in  $X_2$ . Then  $U_1$  is a solid torus and the frontier  $E_1$  of  $U_1$  in  $X_1$  is an annulus with winding number 2 in  $U_1$ . Thus  $E_1$  is parallel to  $\partial X_1 \setminus (\partial U_1 \cap A)$  in  $X_1 \setminus U_1$ . The manifold  $U_2$  is also a solid torus, the frontier of  $U_2$  in  $X_2$  is a pair of annuli  $E'_2, E''_2$ , and  $E'_2$  is parallel to  $E''_2$  in  $U_2$ . We may assume that  $U_1 \cap A$  is equal to a component of  $U_2 \cap A$ . Let  $U_3$  and  $U_4$  be the two components of  $X_2 \setminus U_2$ , and we may assume that  $U_4$  is the one which contains  $\partial X_2 \setminus A$  and that  $E''_2 \subset \partial U_4$  (cf. Figure 27). Note that  $U_4$  must be a solid torus in which  $E''_2$  is parallel to  $\partial U_4 \setminus E''_2$  for otherwise the frontier of  $U_4$  in  $X$  would be an essential annulus in  $X$  which has the same boundary as the annulus  $A$  in  $T_K$  but has less number of intersection components with  $V_{\bar{\alpha}}$  than  $A$ . Thus  $U_3$  is either a torus cross interval or a solid torus in which  $E'_2$  has winding number larger than two. Now let  $A'$  be the annulus  $E_1 \cup E'_2 \cup [A \setminus (U_1 \cup U_2)]$  (cf. Figure 27). Then  $A'$  is an essential annulus in  $X$  such that  $\partial A' = \partial A$  in  $T_K$  but  $A'$  has less number of intersection components with  $V_{\bar{\alpha}}$  than  $A$ , yielding a final contradiction.  $\diamond$

Note that Lemma 7.11 still holds in the present case.

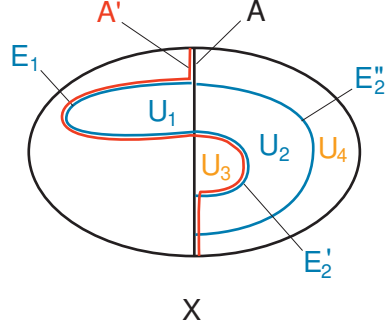

FIGURE 27.

**Claim 8.12.**  $\Gamma_P$  cannot have a family of more than  $\frac{n}{2} + 1$  parallel  $D$ -edges.

*Proof of Claim 8.12.* Otherwise  $\Gamma_P$  has either an  $D$ -edge extended  $S$ -cycle or two  $S$ -cycles with distinct label pairs, contradicting Claim 8.11 or Lemma 7.11 respectively.  $\diamond$

**Claim 8.13.** In  $\Gamma_Q$ , the endpoints of the  $AB$ -edges incident to  $b_i$  are consecutive around  $b_i$ , for each fixed  $i = 1, \dots, n$ .

*Proof of Claim 8.13.* By the parity rule all the  $AB$ -edges incident to a fixed  $b_i$  have their other endpoint on a fixed component of  $\partial A = \{a_1, a_2\}$ . Also observe that all the  $b_i$ 's which are connected to a fixed component of  $\{a_1, a_2\}$  by  $AB$ -edges have the same sign, and thus there can be no  $B$ -edges connecting between these  $b_i$ 's (because all  $B$ -edges are negative). Noticing that every vertex  $b_i$  is incident to some  $B$ -edges in  $\Gamma_Q$ , one can now see that the lemma follows. (cf. Lemma 7.17 and its proof.)  $\diamond$

**Claim 8.14.** The endpoints with label  $i$  on  $d_V$  of the  $CD$ -edges of  $\Gamma_P$  (when non-empty) are consecutive among all the edge-endpoints with label  $i$  on  $d_V$ , for each fixed  $i = 1, \dots, n$ .

*Proof of Claim 8.14.* This follows from Claim 8.13 and the condition that  $\Delta = 4$ . (cf. Corollary 7.18 and its proof.)  $\diamond$

**Claim 8.15.**  $n = 2$ .

*Proof of Claim 8.15.* Since there are at most 8  $CD$ -edges, there are at least  $(8n - 8)/2 = 4n - 4$   $D$ -edges in  $\Gamma_P$ . Thus there is a family of parallel  $D$ -edges in  $\Gamma_P$  with at least  $(4n - 4)/5$  edges. By Claim 8.12,  $(4n - 4)/5 \leq \frac{n}{2} + 1$ . Thus  $n \leq 6$ . So assume for contradiction that  $n = 6$  or 4.

If  $n = 6$ , then there are exactly 8  $CD$ -edges and 5 families of parallel  $D$ -edges, each having 4 edges. So part of  $\Gamma_P$  maybe assumed as shown in Figure 28. So there is an extended  $D$ -edge  $S$ -cycle in  $\Gamma_P$ , contradicting Claim 8.11.

So  $n = 4$ . Note that the total weights of all  $D$ -edges in  $\bar{\Gamma}_P$  is at least 12 and each  $D$ -edge of  $\bar{\Gamma}_P$  has weight at most 3 by Claim 8.12. It follows that  $\bar{\Gamma}_P$  has no  $C$ -edges. It also follows that there is an  $D$ -edge  $\bar{e}$  in  $\bar{\Gamma}_P$  of type  $O$  and with weight 3. Let  $c_j$  be the single vertex that  $\bar{e}$  cuts off as given in the definition of an  $O$ -type edge. We note that there must be two  $CD$ -edges

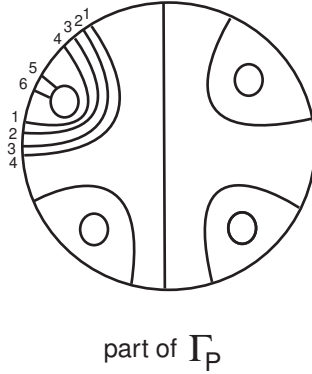

FIGURE 28.

incident to  $c_j$ . For otherwise a part of  $\Gamma_P$  is as shown in Figure 29. In the figure the face  $f$  is bounded by an  $D$ -edge  $S$ -cycle and thus is contained in  $X_1$  (which is a solid torus), but the face  $g$  is also contained in  $X_1$ , yielding a contradiction since it abuts a puncture  $c_i$ , which cannot exist in the solid torus  $X_1$ .

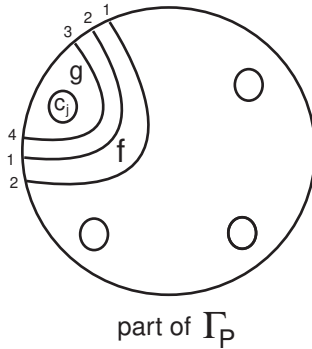

FIGURE 29.

Hence part of  $\Gamma_P$  is as shown in Figure 30(a). If there is no  $N$ -type  $D$ -edge in  $\bar{\Gamma}_P$ , then there are exactly 8  $CD$ -edges and 12  $D$ -edges in  $\Gamma_P$ , and  $\Gamma_P$  must look like that shown in Figure 30(b). But then we get a contradiction with Claim 8.14, considering the label 1. Therefore part of  $\Gamma_P$  maybe assumed as shown in Figure 30(c) where the edge  $e$  has label 4 at its upper endpoint.

By the parity rule the lower endpoint of the edge  $e$  has label 1 or 3. In the former case the part of the graph  $\Gamma_P$  on the left-hand side of the edge  $e$  must be as shown in Figure 30(d) or (e), by considering labels around  $d_V$ . But then the face  $g$  shown in both of the subcases is bounded by an  $D$ -edge Scharlemann cycle of order 3 and lies on  $X_1$ -side, contradicting Lemma 7.11. In the latter case the left-hand side of the edge  $e$  must be as shown in Figure 30(f). But then we get a contradiction with Claim 8.14 by looking at the label 4.  $\diamond$

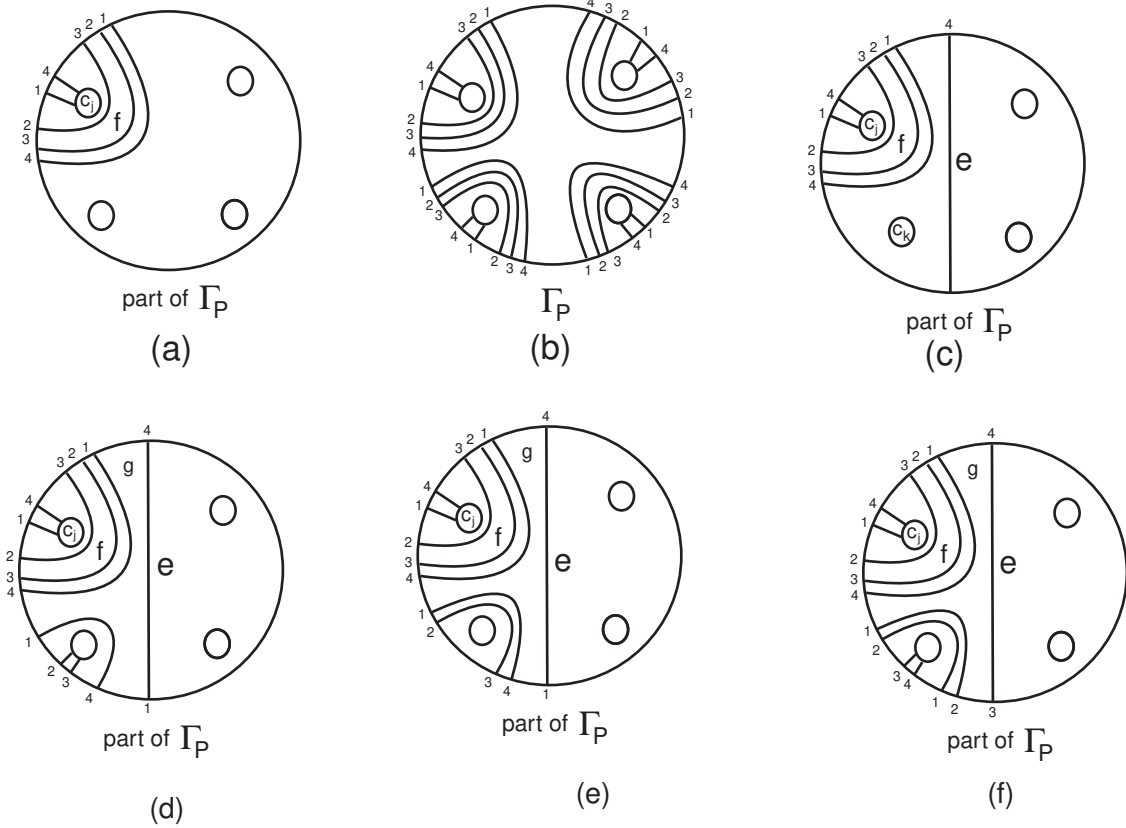

FIGURE 30.

So  $n = 2$ . By the proof of Lemma 8.8 we may only consider the situation when  $\Gamma_P$  contains  $D$ -edge  $S$ -cycles, i.e.  $\Gamma_P$  contains parallel  $D$ -edges. But note that each parallel family of  $D$ -edges contains at most two edges by Claim 8.10. We have at least 4  $D$ -edges in  $\Gamma_P$ .

Note that Lemma 7.14 is still valid in the present case.

Recall that  $k$  is the number of  $D$ -edges in  $\bar{\Gamma}_P$  and  $k \leq 5$ . In the current case  $k \geq 2$ . Note that we have assumed that there are at least  $k + 1$   $D$ -edges in  $\Gamma_P$ .

If  $k = 4$  or  $5$ , then  $D$ -edges in  $\bar{\Gamma}_P$  are as shown in Figure 6 or Figure 7, where at least one edge has weight 2. One can easily see from the figures that  $\Gamma_P$  must have, in each case, a disk face bounded by an  $D$ -edge Scharlemann cycle of order 3 or 4 that lies in  $X_2$ . Hence  $X_2$  is a solid torus by Lemma 7.14 and thus there are 8  $CD$ -edges in  $\Gamma_P$ . But there are at least 5  $D$ -edges in  $\Gamma_P$ . So the valency of the vertex  $d_V$  would be at least 18 in  $\Gamma_P$ , contradicting to the assumption that the valency of  $d_V$  is 16 in  $\Gamma_P$ .

If  $k = 3$ , then the three  $D$ -edges in  $\bar{\Gamma}_P$  are as shown in Figure 10 (a) (b) (c), with at least one edge having weight 2. We first consider Case (a) of Figure 14. If the vertex  $c_4$  has valency 2 in  $\Gamma_P$ , then  $\Gamma_P$  has a disk face with at least two  $d_V$ -corners, contained in  $X_2$ . Hence  $X_2$  is a solid torus and every  $c_i$  has valency two in  $\Gamma_P$ . Now it is easy to see that Claim 8.14 is violated. So the valency of  $c_4$  is zero, and thus there are at least 5  $D$ -edges in  $\Gamma_P$ . Since there are at most

6  $D$ -edges in  $\Gamma_P$ , at least two of  $c_1, c_2, c_3$  have valency 2. Now it is easy to see that we have a contradiction again with Claim 8.14. Next we consider Case (b) of Figure 14. In this case  $\Gamma_P$  has a disk face bounded by an  $D$ -edge Scharlemann cycle of order 3, contained in  $X_2$ . Hence  $X_2$  is a solid torus by Lemma 7.14 and thus every  $c_i$  has valency 2 in  $\Gamma_P$ . Now one can see a contradiction with Claim 8.14. Lastly in Case (c) of Figure 14 one can easily see a contradiction with Claim 8.14 once again.

If  $k = 2$ , then the two  $D$ -edges in  $\bar{\Gamma}_P$  are as shown in Figure 14 (a) (b), each having weight 2. Also there are exactly 8  $CD$ -edges in  $\Gamma_P$ . Now it is easy to see that Claim 8.14 is violated in both (a) and (b) cases.  $\diamond$

## 9. FURTHER ASSUMPTIONS, REDUCTIONS, AND BACKGROUND MATERIAL

The remainder of the paper deals with the cases that  $F$  is neither a fibre or semi-fibre.

**Lemma 9.1.** *If  $F$  is neither a fibre nor semi-fibre in  $M$  and  $b_1(M) \geq 2$ , then*

$$\Delta(\alpha, \beta) \leq \begin{cases} 1 & \text{if } M(\alpha) \text{ is very small} \\ 5 & \text{otherwise} \end{cases}$$

*Proof.* If  $b_1(M) \geq 2$ , there is a closed, non-separating, Thurston norm minimizing surface  $S$  in the interior of  $M$ . By [Ga, Corollary, page 462],  $S$  remains Thurston norm minimizing in  $M(\gamma)$  for all but at most one slope  $\gamma_0$  on  $\partial M$ . If  $\alpha = \gamma_0$ , a result of Wu implies that  $\Delta(\alpha, \beta) \leq 1$  (cf. [BGZ1, Proposition 5.1]), so suppose that  $\alpha \neq \gamma_0$ . Then  $M(\alpha)$  cannot be very small since it contains  $S$  as an essential surface. Theorem 1.2 of [BGZ1] now shows that  $\Delta(\alpha, \beta) \leq 5$ .  $\diamond$

We will apply the results of [BGZ2] in what follows, which requires that more care be taken in the choice of  $F$ . Here is a list of assumptions we will make in our proof of Theorem 1.2 when  $F$  is neither a fibre nor semi-fibre. The references which justify the sufficiency of these assumptions are listed as well.

### Assumptions 9.2.

- (1)  $b_1(M) = 1$  (cf. Lemma 9.1).
- (2)  $M$  does not admit a fibre or semi-fibre which is an essential twice-punctured torus of boundary slope  $\beta$  (cf. Propositions 7.1 and 8.1).
- (3)  $M$  admits no essential once-punctured torus of boundary slope  $\beta$  (cf. [BGZ3, Theorem 1.3]).
- (4)  $F$  is chosen according to the assumptions of [BGZ2, §2].
- (5) If  $M_F$  is not connected, then it is a union of two genus 2 handlebodies (cf. [BGZ3, Proposition 3.3]).

Next we provide a summary of the notation and terminology from [BGZ2] that will be used below.

Let  $F$  be chosen as above. If  $F$  separates  $M$  we take  $S$  to be  $F$ . Otherwise we take  $S$  to be the frontier of a small radius tubular neighbourhood of  $F$  in  $M$ . Thus  $S$  consists of two parallel copies  $F_1, F_2$  of  $F$ . In either case  $S$  splits  $M$  into two components  $X^+$  and  $X^-$ . By Assumption 9.2 (2) above, we can suppose that  $X^+$  is not an  $I$ -bundle.

Let  $\widehat{S}$  be a closed surface in  $M(\beta)$  obtained by attaching disjoint meridian disks of the  $\beta$ -filling solid torus to  $S$ . Then  $\widehat{S}$  splits  $M(\beta)$  into two compact submanifolds  $\widehat{X}^+$  containing  $X^+$  and  $\widehat{X}^-$  containing  $X^-$ , each having incompressible boundary  $\widehat{S}$ .

It was shown in [BCSZ1] how to construct an immersion  $h : Y \rightarrow M(\alpha)$  where  $Y$  is a disk or torus, a labeled “intersection” graph  $\Gamma_F = h^{-1}(F) \subset Y$ , and, for each sign  $\epsilon = \pm$ , a sequence of characteristic subsurfaces

$$F = \dot{\Phi}_0^\epsilon \supseteq \dot{\Phi}_1^\epsilon \supseteq \dot{\Phi}_2^\epsilon \supseteq \dots \supseteq \dot{\Phi}_n^\epsilon \supseteq \dots$$

See [BCSZ1, §5] for the definition of the  $j$ -th characteristic subsurface  $\Phi_j^\epsilon \subseteq S$ . We shall assume throughout the paper that  $\dot{\Phi}_j^\epsilon$  is neatly embedded in  $S$  ([BGZ2, §3.1]). It is characterized up to ambient isotopy by the following property:

$$(*) \left\{ \begin{array}{l} \text{a large function } f_0 : K \rightarrow S \text{ admits an essential homotopy of length } j \text{ which starts} \\ \text{on the } \epsilon\text{-side of } S \text{ if and only if it is homotopic in } S \text{ to a map with image in } \Phi_j^\epsilon \end{array} \right.$$

See [BCSZ1, Proposition 5.2.8]. When  $j = 1$ , basic Jaco-Shalen-Johannson theory guarantees the existence of an  $(I, S^0)$ -bundle pair  $(\Sigma_1^\epsilon, \Phi_1^\epsilon) \subset (X^\epsilon, S)$ . It was shown in [BGZ2, Proposition 4.9] that we can assume that  $(\Sigma_1^\epsilon, \Phi_1^\epsilon)$  is neatly embedded in  $(X^\epsilon, S)$  ([BGZ2, §3.2]).

As in [BGZ2, §3.2] we take  $\dot{\Phi}_j^\epsilon$  to be the union of the components of  $\Phi_j^\epsilon$  which contain some outer boundary components and  $\check{\Phi}_j^\epsilon$  to be the neat subsurface in  $S$  obtained from the union of  $\dot{\Phi}_j^\epsilon$  and a closed collar neighbourhood of  $\partial S - \partial\dot{\Phi}_j^\epsilon$  in  $S - \dot{\Phi}_j^\epsilon$ . There are corresponding  $I$ -bundle pairs  $(\check{\Sigma}_1^\epsilon, \check{\Phi}_1^\epsilon)$  and  $(\check{\Sigma}_1^\epsilon, \check{\Phi}_1^\epsilon)$  neatly embedded in  $(X^\epsilon, S)$ .

A neat subsurface  $S_0$  of  $S$  is called *tight* if it caps off to a disk in  $\widehat{S}$ . Equivalently,  $S_0$  is a connected, planar, neat subsurface of  $S$  with one inner boundary component.

We use  $t_j^\epsilon$  to denote the number of tight components of  $\check{\Phi}_j^\epsilon$ . If  $j$  is odd,  $t_j^\epsilon$  is even, while if  $j$  is even,  $t_j^+ = t_j^-$ . See [BGZ2, §6].

An *intersection graph*  $\Gamma_F$  can be constructed in a disk or torus  $Y$  from an immersion

$$(9.0.1) \quad h : Y \rightarrow M(\alpha)$$

(cf. [BGZ2, Section 11]). The immersion maps the vertices of  $\Gamma_F$  to meridian disks of the  $\alpha$ -filling torus, edges of  $\Gamma_F$  to  $F$ , and faces of  $\Gamma_F$  to  $X^+$  or  $X^-$ . For simplicity we shall say a face of  $\Gamma_F$  is contained in  $X^\epsilon$  if its image under the immersion is contained there. We refer to [BGZ2, Sections 11 and 12] for terms, notations and basic facts concerning  $\Gamma_F$ .

**Remark 9.3.** Note that the intersection graph  $\Gamma_F$  in  $Y$  has the following property: either  $\Gamma_F$  has a connected component which lies in a subdisk of  $Y$  or  $Y$  is a torus and every face of  $\Gamma_F$  is a disk or an annulus. So we may and shall assume that either  $\Gamma_F$  is a connected graph in a

disk or it is a graph in a torus with only disk faces and/or annulus faces. It turns out that our graph related arguments are never affected whether annulus faces exist or not.

#### 10. THE PROOF OF THEOREM 1.2 WHEN $F$ IS NON-SEPARATING BUT NOT A FIBRE

In this section we prove that part of Theorem 1.2 dealing with the case that  $F$  is non-separating but not a fibre. We suppose throughout that Assumptions 4.3 and 9.2 hold. Note that we can assume that the components of  $\partial F$  are like-oriented on  $\partial M$ . For otherwise we can attach a peripheral annulus to  $F$  to obtain a closed non-separating genus two surface in  $M$ . This surface must be incompressible in  $M$  since  $M$  is hyperbolic. It follows from [CGLS, Theorem 2.4.3] that  $\beta$  is a singular slope, which contradicts Assumptions 4.3(4). By construction,  $X^- = F \times I$ .

We shall prove

**Proposition 10.1.** *Suppose that  $M$  is a hyperbolic knot manifold which contains an essential, non-separating twice-punctured torus  $F$  of boundary slope  $\beta$  and let  $\alpha$  be a slope on  $\partial M$  such that  $M(\alpha)$  is an irreducible small Seifert manifold. If  $F$  is not a fibre and Assumptions 4.3 and 9.2 hold, then*

$$\Delta(\alpha, \beta) \leq \begin{cases} 4 & \text{if } M(\alpha) \text{ is very small} \\ 5 & \text{otherwise} \end{cases}$$

We begin with a result whose proof follows from [BGZ2].

**Proposition 10.2.** *Suppose that  $F$  is a non-separating, essential, twice-punctured torus of slope  $\beta$  in a hyperbolic knot manifold  $M$  which completes to an essential torus in  $M(\beta)$  but is not a fibre in  $M$ . Suppose as well that  $M(\alpha)$  is an irreducible small Seifert manifold.*

(1) *If  $t_1^+ > 0$ , then  $\Delta(\alpha, \beta) \leq \begin{cases} 3 & \text{if } M(\alpha) \text{ is very small} \\ 4 & \text{otherwise} \end{cases}$*

(2) *If  $t_1^+ = 0$ , then*

(a)  $\Delta(\alpha, \beta) \leq \begin{cases} 4 & \text{if } M(\alpha) \text{ is very small} \\ 6 & \text{otherwise} \end{cases}$

(b)  $M(\beta)_{\widehat{F}}$  *admits a Seifert structure with base orbifold an annulus with one cone point.*

*Proof.* Assertion (2)(b) of the proposition is a consequence of [BGZ2, Lemma 7.10]. Assertion (2)(a) follows from [BGZ2, Propositions 13.1 and 13.2], as does the general inequality  $\Delta(\alpha, \beta) \leq 4$  when  $t_1^+ > 0$  claimed in assertion (1).

Assume that  $t_1^+ > 0$  and  $M(\alpha)$  is very small. Since  $t_1^+$  is even and the number of boundary components  $F$  is bounded below by  $\frac{t_1^+}{2}$ , we have  $t_1^+ \in \{2, 4\}$ . As  $M(\alpha)$  is very small, the graph  $\overline{\Gamma}_S$  is contained in a 2-disk and so it has a vertex of valency 5 or less (e.g. see [BGZ2, Proposition 12.2 and Corollary 12.4]). Hence if  $t_1^+ = 4$ , then [BGZ2, Inequality 13.0.1] shows that  $\Delta(\alpha, \beta) \leq 2$ . Suppose then that  $t_1^+ = 2$  and note that  $\overline{\Gamma}_S$  has a vertex of valency 3 or less,

for if it doesn't, [BGZ2, Lemma 11.6 and Proposition 11.5(2)] imply that  $\bar{\Gamma}_S$  is rectangular and so is contained in a torus, contrary to our assumptions. But then [BGZ2, Inequality 13.0.1] shows that  $\Delta(\alpha, \beta) \leq 3$ , so we are done.  $\diamond$

**10.1. Proof of Proposition 10.1 when  $M(\alpha)$  is not very small.** By Proposition 10.2 we can suppose that  $t_1^+ = 0$  in this subsection and the base orbifold  $S^2(a, b, c)$  of  $M(\alpha)$  is hyperbolic.

Recall from §9 that  $S$  is the frontier of  $X^+$  in  $M$  and consists of two parallel copies  $F_1, F_2$  of  $F$ . By Proposition 10.2 we can assume that  $\Delta(\alpha, \beta) = 6$  in order to obtain a contradiction. In this case, the proof of [BGZ2, Proposition 13.2] shows that the reduced graph  $\bar{\Gamma}_S$  is rectangular with every edge having weight 6, both  $\dot{\Phi}_3^+$  and  $\dot{\Phi}_5^-$  consist of a pair of tight components, each a twice-punctured disk,  $\dot{\Phi}_5^+$  is a collar on  $\partial S$ , and so contains no large components.

Let  $b_1, \dots, b_4$  denote the components of  $\partial S = \partial F_1 \cup \partial F_2$  indexed as they appear successively along  $\partial M$  and where  $b_1 \cup b_3 = \partial F_1$  and  $b_2 \cup b_4 = \partial F_2$ . These four circles cut  $\partial M$  into four annuli  $A_{i, i+1}, i = 1, \dots, 4$ , such that  $\partial A_{i, i+1} = b_i \cup b_{i+1}$  (indexed (mod 4)). We assume that  $\partial X^+ = S \cup A_{2,3} \cup A_{4,1}$ .

As in [BGZ3], an  $n$ -gon in  $X^+$  means a singular disk  $D$  with  $\partial D \subseteq \partial X^+$  such that  $\partial D \cap (A_{2,3} \cup A_{4,1})$  is a set of  $n$  embedded essential arcs in  $A_{2,3} \cup A_{4,1}$ , called the *corners* of  $D$ , and  $\partial D \cap S$  is a set of  $n$  singular arcs, called the *edges* of  $D$ . As we go around  $\partial D$  in some direction we get a cyclic sequence of  $X_2^{\pm 1}$  and  $X_4^{\pm 1}$ -corners, where  $X_2, X_2^{-1}$  indicate that  $\partial D$  is running across  $A_{2,3}$  from 2 to 3 or from 3 to 2, respectively, and  $X_4, X_4^{-1}$  indicate that  $\partial D$  is running across  $A_{4,1}$  from 4 to 1 or 1 to 4, respectively. In this way  $D$  determines a cyclic word  $W = W(X_2^{\pm 1}, X_4^{\pm 1})$ , well-defined up to inversion, and we say that  $D$  is *of type*  $W$ . (Thus  $D$  is of type  $W$  if and only if it is of type  $W^{-1}$ .) We emphasize that  $W$  is an unreduced word; for example  $X_2$  and  $X_2 X_4 X_4^{-1}$  are distinct.

There are no  $n$ -gons in  $X^+$  with  $n$  odd (cf. [BGZ3, Lemma 11.6]).

**Lemma 10.3.** *There is no bigon  $D$  in  $X^+$  whose edges  $e_1, e_2$  are essential paths in  $(\dot{\Phi}_5^-, \partial S)$  and for which the inclusion  $(D, e_1 \cup e_2) \rightarrow (X^+, \dot{\Phi}_5^-)$  is essential as a map of pairs.*

**Proof.** Suppose otherwise that such a bigon  $D$  exists. Then  $D$  gives rise to an essential homotopy between its two edges and thus the edges of  $D$  can be homotoped, relative to their end points, into  $\dot{\Phi}_1^+$ . Then the essential intersection  $\dot{\Phi}_5^- \wedge \dot{\Phi}_1^+$  contains a large component and therefore so does  $\dot{\Phi}_6^+ = \tau_+(\dot{\Phi}_5^- \wedge \dot{\Phi}_1^+)$ , contrary to the fact that  $\dot{\Phi}_5^+$  has no large components.  $\diamond$

Recall that  $h$  is the  $\pi_1$ -injective map from the torus  $T$  into  $M(\alpha)$  which induces the graph  $\Gamma_S$  in  $T$ . For a subset  $s$  of  $T$  we use  $s^*$  to denote its image under the map  $h$ . The image under  $h$  of every edge of a rectangular face of  $\Gamma_S$  is contained in  $\dot{\Phi}_5^-$ .

For notational simplicity, let us write  $\dot{\Phi}_5^- = Q$ , a pair of twice-punctured disks. Obviously we have  $b_1 \cup b_3$  is contained in one component of  $Q$  and  $b_2 \cup b_4$  in the other.



A singular disk  $D \subset X^+$  whose edges are contained in  $Q$  will be called a  $Q$ -disk. An *essential*  $Q$ -disk is a  $Q$ -disk  $D$  such that each edge of  $D$  is an essential arc in  $Q$ .

Note that a  $Q$ -disk has no 12-, or 14-, or 32- or 34-edge. This simple fact will be used many times in the rest of the proof in determining the type  $W(D)$  of a  $Q$ -disk  $D$ .

**Lemma 10.4.** *An essential  $Q$ - $n$ -gon,  $n \leq 4$ , is a 4-gon of type  $X_2X_4^{-1}X_4X_4^{-1}$  or  $X_4X_2^{-1}X_2X_2^{-1}$ .*

**Proof.** Let  $E$  be an essential  $Q$ - $n$ -gon,  $n \leq 4$ . By the loop theorem ([He, Theorem 4.10]) we get an essential embedded  $Q$ -disk  $D$ , with  $\{\text{corners of } D\} \subset \{\text{corners of } E\}$ . Thus  $D$  is a  $k$ -gon with  $k \leq 4$ . We know  $k$  must be even, and  $D$  cannot be a bigon by Lemma 10.3. Hence  $D$  is a 4-gon.

There are three possibilities:  $D$  has either

- (A) all  $X_2$ -corners (or all  $X_4$ -corners);
- (B) two  $X_2$ -corners and two  $X_4$ -corners;
- (C) one  $X_2$ -corner and three  $X_4$ -corners (or vice versa).

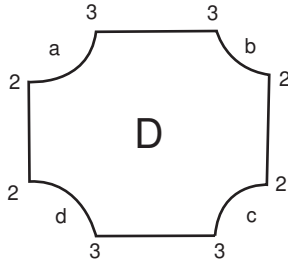

FIGURE 31.

In Case (A),  $W(D) = X_2X_2^{-1}X_2X_2^{-1}$  (or  $X_4X_4^{-1}X_4X_4^{-1}$ ). Label the corners of  $D$   $a, b, c, d$  as shown in Figure 31. Then  $\partial D$  is as shown in Figure 32. Let  $Y = \widehat{X}^- \cup H_{(23)}$ . Note that  $\partial Y$  is a surface of genus 2. We see from Figure 32 that  $\partial D$  is isotopic in  $\partial Y$  to a meridian of  $H_{(23)}$ , and so bounds a non-separating disk  $D' \subset Y$ . Then  $D \cup D'$  is a non-separating 2-sphere in  $M(\beta)$ , a contradiction.

In Case (B), the only possibilities for  $W(D)$  are  $X_2X_2^{-1}X_4X_4^{-1}$  and  $X_2X_4^{-1}X_2X_4^{-1}$ . In the first case,  $\partial D$  also contains a 1-loop and a 3-loop, which must intersect. In the second case, let  $U = \widehat{Q} \times I \cup H_{(23)} \cup H_{(41)} \cup N(D) \subset \widehat{X}^+$ . Then  $U$  is a punctured projective space in  $X^+$ , a contradiction.

Hence Case (C) must hold; so suppose that  $D$  has one  $X_2$ -corner and three  $X_4$ -corners. Since  $\{\text{corners of } D\} \subset \{\text{corners of } E\}$ ,  $E$  is also a 4-gon with one  $X_2$ -corner and three  $X_4$  corners. The possibility for  $W(E)$  is  $X_2X_4^{-1}X_4X_4^{-1}$ . This completes the proof of Lemma 10.4  $\diamond$

**Lemma 10.5.** *There do not exist disjoint  $Q$ -disks of types  $X_2X_4^{-1}X_4X_4^{-1}$  and  $X_4X_2^{-1}X_2X_2^{-1}$ .*

**Proof.** Let  $D_1, D_2$  be  $Q$ -disks of types  $X_2X_4^{-1}X_4X_4^{-1}$  and  $X_4X_2^{-1}X_2X_2^{-1}$ , respectively. Then  $\partial D_1$  contains a 1-loop and  $\partial D_2$  contains a 3-loop, and these must intersect.  $\diamond$

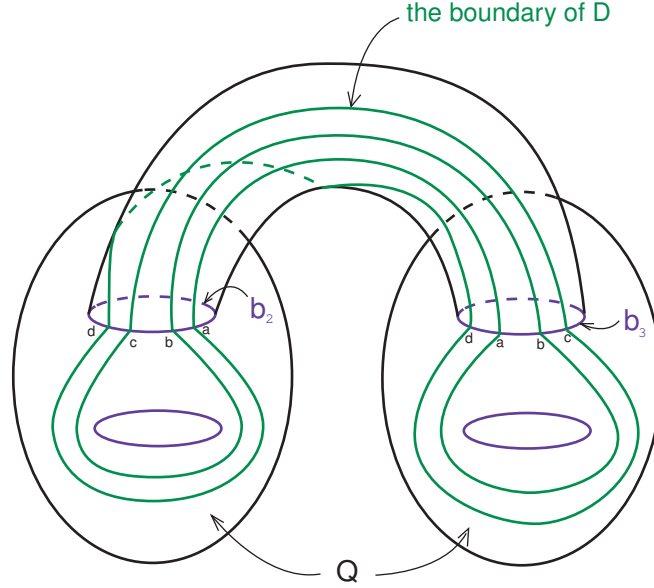

FIGURE 32.

**Lemma 10.6.** *There cannot be essential  $Q$ -4-gons of both types  $X_2X_4^{-1}X_4X_4^{-1}$  and  $X_4X_2^{-1}X_2X_2^{-1}$ .*

**Proof.** Let  $E_1, E_2$  be  $Q$ -disks of types  $X_2X_4^{-1}X_4X_4^{-1}$  and  $X_4X_2^{-1}X_2X_2^{-1}$  respectively. By the loop theorem and Lemma 10.4 we get embedded  $Q$ -disks  $D_1$  and  $D_2$  of these types. By Lemma 10.5,  $D_1$  and  $D_2$  must intersect; consider an arc of intersection, coming from the identification of arcs  $u_i \subset D_i, i = 1, 2$ . We may assume that the endpoints of  $u_i$  lie on distinct edges of  $D_i, i = 1, 2$ . Then  $u_i$  separates  $D_i$  into two disks,  $D'_i$  and  $D''_i$ , say, where  $D'_i$  contains either one or two corners of  $D_i$ .

If  $D'_1$  and  $D'_2$  each contain a single corner, and these corners are distinct, then  $D'_1 \cup D'_2$  is a  $Q$ -bigon with one  $X_2$ - and one  $X_4$ -corner, contradicting Lemma 10.3.

If  $D'_1$  and  $D'_2$  both contain, say, a single  $X_2$ -corner, then  $u_1$  is as shown in Figure 33, which also shows one of the three possibilities for  $u_2$ . Since  $b_1$  and  $b_3$  lie in one component of  $Q$ , say  $Q_1$ , and  $b_2$  and  $b_4$  lie in the other component, say  $Q_2$ , and each of the arcs  $u_1$  and  $u_2$  has one endpoint in  $Q_1$  and one in  $Q_2$ ,  $u_1$  and  $u_2$  must be identified as shown in Figure 33. Then  $D_1^* = D''_1 \cup D'_2$  is a  $Q$ -disk of type  $X_2X_4^{-1}X_4X_4^{-1}$  having fewer intersections than  $D_1$  with  $D_2$ .

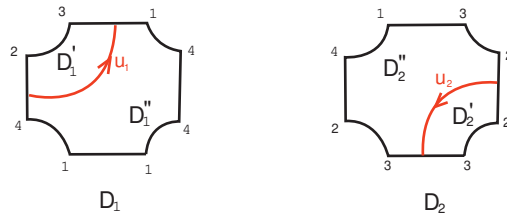

FIGURE 33.

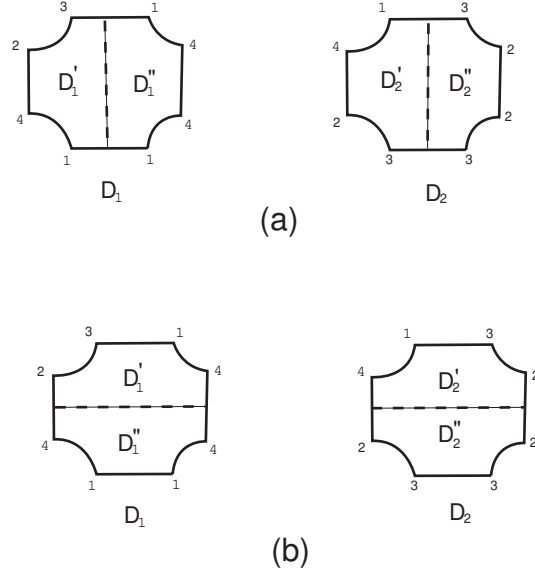

FIGURE 34.

If each of  $D'_i$  and  $D''_i$  contains two corners,  $i = 1, 2$ , the two possibilities for  $u_1$  and  $u_2$  are illustrated in Figure 34, (a) and (b). In both cases,  $D_1^* = D'_1 \cup D''_1$  is again a  $Q$ -disk of type  $X_2X_4^{-1}X_4X_4^{-1}$  having fewer intersections with  $D_2$ .

Applying the loop theorem to the disk  $D_1^*$  constructed above, and using Lemma 10.4, we get an embedded  $Q$ -disk of type  $X_2X_4^{-1}X_4X_4^{-1}$  having fewer intersections with  $D_2$  than  $D_1$ . Continuing, we eventually get disjoint embedded  $Q$ -disk of types  $X_2X_4^{-1}X_4X_4^{-1}$  and  $X_4X_2^{-1}X_2X_2^{-1}$ , contradicting Lemma 10.5. This completes the proof of Lemma 10.6.  $\diamond$

Since each edge of  $\bar{\Gamma}_S$  has weight 6, consecutive 4-gon corners of  $\Gamma_S$  at a given vertex are distinct. Hence the total number of  $X_2$ -corners in the 4-gon faces of  $\Gamma_S$  is the same as the total number of  $X_4$ -corners. Since a 4-gon face of  $\Gamma_S$  is an essential  $Q$ -disk, this contradicts Lemmas 10.4 and 10.6.

**10.2. Refinements to the very small case when  $t_1^+ = 0$ .** In this subsection we refine the very small case of Proposition 10.1 when  $t_1^+ = 0$ . Assume that this is the case and recall that  $M(\beta)_{\hat{F}}$  admits a Seifert structure with base orbifold an annulus with one cone point of order  $n \geq 2$  (cf. Proposition 10.2). Let  $T_0$  and  $T_1$  be the boundary components of  $M(\beta)_{\hat{F}}$  and  $\phi_0, \phi_1$  the Seifert slope of  $M(\beta)_{\hat{F}}$  on  $T_0, T_1$  respectively. Denote by  $f : T_0 \rightarrow T_1$  the gluing map which produces  $M(\beta)$  and set

$$d = \Delta(f_*(\phi_0), \phi_1)$$

**Proposition 10.7.** *Let  $M$  be a hyperbolic knot manifold which contains an essential non-separating twice-punctured torus  $F$  of boundary slope  $\beta$  and let  $\alpha$  be a slope on  $\partial M$  such that*

$M(\alpha)$  is a very small Seifert manifold. If  $t_1^+ = 0$  and  $d \neq 1$ , then

$$\Delta(\alpha, \beta) \leq \begin{cases} 1 & \text{if } d = 0 \text{ or } \alpha \text{ is of } C\text{-type} \\ 2 & \text{if } \alpha \text{ is of } D, T \text{ or } O\text{-type, or } (a, b, c) \text{ is } (2, 3, 6) \text{ or } (3, 3, 3) \\ 3 & \text{if } \alpha \text{ is of } I\text{-type or } (a, b, c) = (2, 4, 4) \end{cases}$$

**Proof.** If  $d = 0$ ,  $M(\beta)$  is a Seifert fibred manifold with base orbifold a torus or Klein bottle with one cone point and therefore  $\beta$  is a singular slope of a closed essential surface in  $M$  (cf. the third paragraph of §4). Proposition 4.1 then shows that  $\Delta(\alpha, \beta) \leq 1$ .

Assume that  $d \geq 2$ . By construction,

$$\pi_1(M(\beta)) \cong \langle \pi_1(M(\beta)_{\widehat{F}}), t : t\gamma t^{-1} = f_*(\gamma) \text{ for all } \gamma \in \pi_1(T_0) \rangle$$

Fix bases  $\{\phi_j, \phi_j^*\}$  of  $\pi_1(T_j)$  ( $j = 0, 1$ ). Then the quotient of  $\pi_1(M(\beta)_{\widehat{F}})$  by the fibre class is isomorphic to  $\mathbb{Z} * \mathbb{Z}/n$  where there are generators  $a, b$  of  $\mathbb{Z}, \mathbb{Z}/n$  respectively so that  $\phi_0^*$  is sent to  $a$  and  $\phi_1^*$  to  $ab$ .

Write  $f_* = \begin{pmatrix} p & q \\ r & s \end{pmatrix}$  with respect to the bases  $\{\phi_j, \phi_j^*\}$ . Since  $d = \Delta(f_*(\phi_0), \phi_1) = |r|$ , the integers  $d$  and  $s$  are coprime.

Since  $d = \Delta(f_*(\phi_0), \phi_1)$ , the quotient of  $\pi_1(\widehat{F})$  by  $\langle \phi_0, \phi_1 \rangle$  is isomorphic to  $\mathbb{Z}/d$  generated by either  $\phi_0^*$  or  $\phi_1^*$ . Hence if we quotient  $\pi_1(M(\beta))$  by the normal closure of  $\langle \phi_0, \phi_1 \rangle$  in  $\pi_1(M(\beta))$  we obtain an epimorphism

$$\varphi : \pi_1(M(\beta)) \rightarrow \langle a, b, t : a^d = 1, b^n = 1, (ab)^d = 1, tat^{-1} = (ab)^s \rangle = \Delta(d, n, d)_{*\psi}$$

where  $\psi : \langle a \rangle \xrightarrow{\cong} \langle ab \rangle, a \mapsto (ab)^s$  (cf. §6.3). If  $\beta^* \in \pi_1(\partial M)$  is a dual class to  $\beta$ , then

$$\varphi(\beta^*) = ta^j ta^l$$

for some integers  $j, l$ .

Let  $Y_0 \subset X_{PSL_2}(\Delta(d, n, d)_{*\psi})$  be a curve constructed in Lemma 6.4(3) by bending a representation  $(\theta, A)$  and define

$$X_0 = (\varphi)^*(Y_0) \subset X_{PSL_2}(M(\beta)) \subset X_{PSL_2}(M)$$

Part (3) of Lemma 6.4 then shows that:

- $X_0$  is strictly non-trivial;
- $\tilde{f}_{\beta^*}$  has a pole at each ideal point of  $X_0$ ;
- if either  $n \neq 2$  or  $d \notin \{2, 4\}$ , then  $X_0$  has exactly two ideal points, and therefore  $s_{X_0} \geq 2$ ;
- if  $n = 2$  and  $d \in \{2, 4\}$ , then  $X_0$  has exactly one ideal point, and therefore  $s_{X_0} \geq 1$ .

By (5.0.2) we have

$$\|\alpha\|_{X_0} = \Delta(\alpha, \beta) s_{X_0}$$

If  $\pi_1(M(\alpha))$  is cyclic, then [BCSZ2, Proposition 8.1] implies that  $\Delta(\alpha, \beta) s_{X_0} = \|\alpha\|_{X_0} = s_{X_0}$  and therefore  $\Delta(\alpha, \beta) = 1$ . It also implies that  $\Delta(\alpha, \beta) s_{X_0} = \|\alpha\|_X \leq 2s_{X_0}$  if  $M(\alpha)$  is a prism

manifold since  $X_0$  contains strictly irreducible characters. Thus  $\Delta(\alpha, \beta) \leq 2$  (cf. [BCSZ2, Proposition 8.1]).

To deal with the remaining cases, note that by Lemma 5.3 of [BZ1] and Propositions 5.2, 5.3 and 5.4 of [Bo], if  $\rho : \pi_1(M(\alpha)) \rightarrow PSL_2(\mathbb{C})$  is an irreducible representation, then

$$\text{image}(\rho) \cong \begin{cases} T_{12} & \text{if } \alpha \text{ is of } T\text{-type} \\ D_3 \text{ or } O_{24} & \text{if } \alpha \text{ is of } O\text{-type} \\ I_{60} = \Delta(2, 3, 5) & \text{if } \alpha \text{ is of } I\text{-type} \\ D_3 \text{ or } T_{12} & \text{if } (a, b, c) = (2, 3, 6) \\ D_2 \text{ or } D_4 & \text{if } (a, b, c) = (2, 4, 4) \\ T_{12} & \text{if } (a, b, c) = (3, 3, 3) \end{cases}$$

Further, in each of these six possibilities at most two such representations have isomorphic images and if two, either  $\alpha$  has  $I$ -type and the image is  $I_{60}$  or  $(a, b, c) = (2, 4, 4)$  and the image is  $D_4$ . Note, in particular, that the image of  $\rho$  is a finite group whose non-trivial elements have order 2, 3, 4, or 5.

Assume that  $\Delta(\alpha, \beta) > 1$ . Then as in the proof of Proposition 7.3 we see that  $J_{X_0}(\alpha) \neq \emptyset$  and is contained in  $X'_0$ . Further, the image  $\chi_\rho$  of an element of  $J_{X_0}(\alpha)$  is a smooth point of  $X_{PSL_2}(M)$ . We know, moreover, that  $\rho(\alpha) = \pm I$ , and so  $\rho$  induces irreducible homomorphism

$$\bar{\rho} : \pi_1(M(\alpha)) \rightarrow PSL(2, \mathbb{C})$$

Lemma 6.4(2) then shows that  $n, d \in \{2, 3, 4, 5\}$ .

Suppose that either  $d \notin \{2, 4\}$  or  $d = 4$  and  $n > 2$ . Then Lemma 6.4(2) shows that  $\theta(\Delta(d, n, d))$  is generated by two elements of order larger than 2 and so is not conjugate into  $\mathcal{N}$ . It follows that  $X_0$  contains no dihedral characters and by Lemma 5.3 of [BZ1] and Propositions 5.2, 5.3 and 5.4 of [Bo] we have  $|J_{X_0}(\alpha)| \leq 2$  with equality only if  $\alpha$  is of  $I$ -type. Since  $s_{X_0} \geq 2$ , Proposition 5.2(2) implies that

$$\Delta(\alpha, \beta) \leq 1 + \frac{2|J_{X_0}(\alpha)|}{s_{X_0}} \leq 3$$

with equality implying that  $\alpha$  is of  $I$ -type.

Next suppose that  $n = 2$  and  $d \in \{2, 4\}$ . That is,  $(d, n, d) = (2, 2, 2)$  or  $(4, 2, 4)$ . In either case the curve  $X_0$  is constructed by bending a representation  $(\theta, A)$  where  $\theta : \Delta(d, n, d) \rightarrow \mathcal{K} \cong \Delta(2, 2, 2)$  and  $A\theta(a)A^{-1} = \theta(ab)$ . It is shown in the last paragraph of the proof of Lemma 6.4 that we can suppose that  $\theta(a) = \pm \begin{pmatrix} i & 0 \\ 0 & -i \end{pmatrix}$  and  $\theta(ab) = \pm \begin{pmatrix} 0 & 1 \\ -1 & 0 \end{pmatrix}$ . Further,  $X_0$  is parametrised by the characters of the representations  $(\theta, A_x)$  where

$$A_x = \pm \begin{pmatrix} x & i/2x \\ ix & 1/2x \end{pmatrix}$$

Suppose that  $\mathcal{K}$  is normal in the image of  $(\theta, A_x)$ . That is, this image is either  $D_2, D_4, T_{12}$ , or  $O_{24}$ . Since  $A_x\theta(a)A_x^{-1} = \theta(ab)$ ,  $A_x$  must commute with  $\theta(b) = \pm \begin{pmatrix} 0 & i \\ i & 0 \end{pmatrix}$ . The reader will verify that this occurs if and only if  $x = \pm \frac{1}{\sqrt{2}}$  or  $x = \pm \frac{i}{\sqrt{2}}$  and if it does, the image of  $(\theta, A_x)$  is isomorphic to  $D_4$ . This rules out the possibility that the image of  $(\theta, A_x)$  is  $D_2, T_{12}$ , or  $O_{24}$  and implies that if the image is conjugate into  $\mathcal{N}$ , it is  $D_4$ . It follows that if  $|J_{X_0}(\alpha)| \neq \emptyset$ , then

either  $\alpha$  has type  $I$  or  $(a, b, c) = (2, 4, 4)$ . Combined with the previous paragraph, this implies that  $\Delta(\alpha, \beta) \leq 2$  when  $\alpha$  has  $T$ -type or  $O$ -type or  $(a, b, c)$  is either  $(2, 3, 6)$  or  $(3, 3, 3)$ .

Suppose then that  $(a, b, c) = (2, 4, 4)$ , Proposition 5.3 of [Bo] combines with Proposition 5.2(2) to show that

$$\Delta(\alpha, \beta) \leq 1 + \frac{|J_{X_0}(\alpha)|}{s_{X_0}} \leq 1 + 2 = 3$$

Finally suppose that  $\alpha$  has  $I$ -type. Then  $|J_{X_0}(\alpha)| \leq 2$  ([BZ1, Lemma 5.3]) and so as Proposition 10.2 shows that

$$\Delta(\alpha, \beta) = 1 + \frac{2|J_{X_0}(\alpha)|}{s_{X_0}}$$

is at most 4, we have  $\Delta(\alpha, \beta) \leq 3$ .

The remaining case to consider is when  $d = 2$  and  $n > 2$ . In this case we have  $s_{X_0} \geq 2$ . Further, no representation of  $\pi_1(M)$  whose character lies on  $X_0$  has image  $D_2$  so the reader will verify that  $2|J_{X_0}(\alpha)| - |\mathcal{N}(\alpha)| \leq 4$  with equality implying that  $\alpha$  is of  $I$ -type. Proposition 5.2(2) now gives the distance bounds in Proposition 10.7. This completes the proof.  $\diamond$

## 11. ALGEBRAIC AND EMBEDDED $n$ -GONS IN $X^\epsilon$

We prove several results which will be used in the remainder of the paper. First we fix some notation.

The twice punctured essential torus  $F$  separates  $M$  into two components  $X^\epsilon$ ,  $\epsilon \in \{+, -\}$ . Let  $b_1, b_2$  denote the components of  $\partial F$ . These two circles cut  $\partial M$  into two annuli  $B^\epsilon$ ,  $\epsilon \in \{+, -\}$ , such that  $\partial X^\epsilon = F \cup B^\epsilon$ . Let  $\widehat{b}_1$  and  $\widehat{b}_2$  be two disjoint meridian disks of the filling solid torus  $V_\beta$  bounded by  $b_1$  and  $b_2$ . These two disks cut  $V_\beta$  into two 3-balls  $H^\epsilon$ ,  $\epsilon \in \{+, -\}$ , such that  $\partial H^\epsilon = B^\epsilon \cup \widehat{b}_1 \cup \widehat{b}_2$ . Recall that  $\widehat{F} = F \cup \widehat{b}_1 \cup \widehat{b}_2$  is an incompressible torus in  $M(\beta)$  and let  $\widehat{X}^\epsilon = X^\epsilon \cup H^\epsilon$ . Here  $H^\epsilon$  can be considered as a 2-handle attached to  $X^\epsilon$  along  $B^\epsilon$ .

Fix a sign  $\epsilon$ . An  $n$ -gon  $D$  in  $X^\epsilon$  is a singular disk  $D$  with  $\partial D \subseteq \partial X^\epsilon = F \cup B^\epsilon$  such that  $\partial D \cap B^\epsilon$  is a set of  $n$  embedded essential arcs in  $B^\epsilon$ , called the *corners* of  $D$ , and  $\partial D \cap F$  is a set of  $n$  singular paths, called the *edges* of  $D$ . As we go around  $\partial D$  in some direction we get a cyclic sequence of  $Y^{\pm 1}$  where  $Y, Y^{-1}$  indicate that  $\partial D$  is running across  $B^\epsilon$  from  $b_1$  to  $b_2$  or from  $b_2$  to  $b_1$ , respectively. In this way  $D$  determines an unreduced cyclic word  $W = W(Y^{\pm 1})$ , well-defined up to inversion. We say that  $D$  is an *algebraic  $m$ -gon* if the absolute value of the exponent sum of  $W$  is  $m$ . We say that  $D$  is *essential* if the map  $(D, \partial D) \rightarrow (X^\epsilon, \partial X^\epsilon)$  is essential as a map of pairs. For instance, an algebraic  $m$ -gon is essential if  $m > 0$ .

We use the term *monogon*, *bigon* or *trigon* for  $n$ -gon when  $n = 1, 2$  or  $3$  respectively. We call an  $n$ -gon an *algebraic monogon*, *algebraic bigon* or *algebraic trigon* if it is an algebraic  $m$ -gon for  $m = 1, 2$  or  $3$ .

**Lemma 11.1.** *Suppose that  $D$  is an embedded  $n$ -gon in  $X^\epsilon$  for some  $n \leq 3$ .*

(1)  *$D$  is not a monogon.*

(2) If  $D$  is an algebraic  $n$ -gon, then  $t_1^\epsilon = 0$  and  $\widehat{X}^\epsilon$  is Seifert fibred over  $D^2$  with two cone points, one of order  $n$ .

(3) If  $n = 3$  and  $D$  is an algebraic monogon, then there is an incompressible separating annulus  $(A_\epsilon, \partial A_\epsilon) \subset (X^\epsilon, F)$  which is the frontier of a trefoil knot exterior  $Q \subset \widehat{X}^\epsilon$  such that

(a)  $Q \cap \widehat{F}$  is an  $\widehat{F}$ -essential annulus whose slope on  $\partial Q$  is the meridional slope of  $Q$ ;

(b) if  $k_\epsilon$  is a core arc of the handle  $H^\epsilon$ , then  $(k_\epsilon, \partial k_\epsilon)$  can be isotoped in  $(Q, \partial Q)$  to lie as a core arc of an essential vertical annulus of  $Q$ .

*Proof.* If  $D$  is a monogon, its union with  $H^\epsilon$  has a 3-ball regular neighbourhood across which we could isotope the essential torus  $\widehat{F}$  into  $M$ , which is impossible. Thus (1) holds, so that  $n = 2$  or  $3$ .

Suppose that the embedded  $n$ -gon  $D$  is also an algebraic  $n$ -gon. Let  $e_1, \dots, e_n \subset F$  be the edges of  $D$ . If  $\hat{b}_1 \cup \hat{b}_2 \cup e_1 \cup \dots \cup e_n$  is contained in a 2-disk  $D_0 \subset \widehat{F}$ , then a regular neighbourhood of  $D_0 \cup D \cup H^\epsilon$  in  $M(\beta)$  is a once-punctured lens space of order  $n$ . But then as  $\widehat{F}$  is essential in  $M(\beta)$ , the latter would be reducible, contrary to Assumption 4.3(6). We claim that  $\hat{b}_1 \cup \hat{b}_2 \cup e_1 \cup \dots \cup e_n$  is contained in an  $\widehat{F}$ -essential annulus  $A$  as depicted in Figure 35. This is obvious when  $n = 2$ . To see it is the case when  $n = 3$ , we just need to note that each of the edges  $e_1, e_2, e_3$  connects  $b_1$  and  $b_2$  and that if the endpoints of the corners of  $D$  at  $b_1$  occur in clockwise (respectively anticlockwise) order, then their other endpoints at  $b_2$  occur in anticlockwise (respectively clockwise) order.

Now define  $Q$  to be a regular neighbourhood of  $A \cup H^\epsilon \cup D$  in  $\widehat{X}^\epsilon$ . The reader will verify that  $\pi_1(Q) \cong \langle t, x : tx^n \rangle$  where  $t$  generates  $\pi_1(A)$  and  $x$  corresponds to the core of  $H^\epsilon$ . Thus  $Q$  is a solid torus in which  $A$  has winding number  $n$ . Let  $A_\epsilon$  be the frontier of  $Q$  in  $X^\epsilon$ . Then  $A_\epsilon$  is an annulus of winding number  $n$  in  $Q$ .

Since  $\widehat{X}^\epsilon - \text{int}(Q)$  is contained in  $M$  and has boundary a torus containing an  $\widehat{F}$ -essential annulus, it must be also a solid torus. Furthermore  $A_\epsilon$  has winding number larger than one in  $\widehat{X}^\epsilon - \text{int}(Q)$  as otherwise  $\widehat{X}^\epsilon$  would be a solid torus and thus  $\widehat{F}$  would be compressible. Thus  $A_\epsilon$  is an essential annulus in  $X^\epsilon$ . It follows that  $\widehat{X}^\epsilon$  is Seifert fibred over  $D^2$  with two cone points, one of order  $n$ .

Recall from §9 that  $t_1^\epsilon$  is an even positive integer bounded above by 2. If  $t_1^\epsilon = 2$ , then  $\check{\Phi}_1^\epsilon$  is a collar on  $\partial F$ , so there are no essential homotopies in  $(X^\epsilon, F)$  of large maps to  $F$ . Let  $K_\beta$  be the core of the  $\beta$ -filling solid torus in  $M(\beta)$  and  $k_\epsilon = K_\beta \cap H^\epsilon$ . Then  $k_\epsilon$  is a core arc of  $H^\epsilon$  and by construction, the pair  $(k_\epsilon, \partial k_\epsilon)$  is isotopic in  $(Q, A)$  to a transverse arc of  $A_\epsilon$ . Thus  $k_\epsilon$  is a transverse arc in an essential annulus  $A'$  properly embedded in  $\widehat{X}^\epsilon$ . Consider a tubular neighbourhood  $N'$  of  $A'$  containing  $H^\epsilon \setminus (\hat{b}_1 \cup \hat{b}_2)$  in its interior and set  $N'_0 = N' \cap M$ . Then  $N'_0 \cap F$  is a disjoint union of two once-punctured tori  $A_1^0$  and  $A_2^0$  and  $(N'_0, A_1^0 \sqcup A_2^0) \cong (A_1^0 \times I, A_1^0 \times \partial I)$ . But then there is an essential homotopy  $(X^\epsilon, F)$  of the large subsurface  $A_1^0$  of  $F$ , a contradiction. Thus  $t_1^\epsilon = 0$ , which completes the proof of (2).

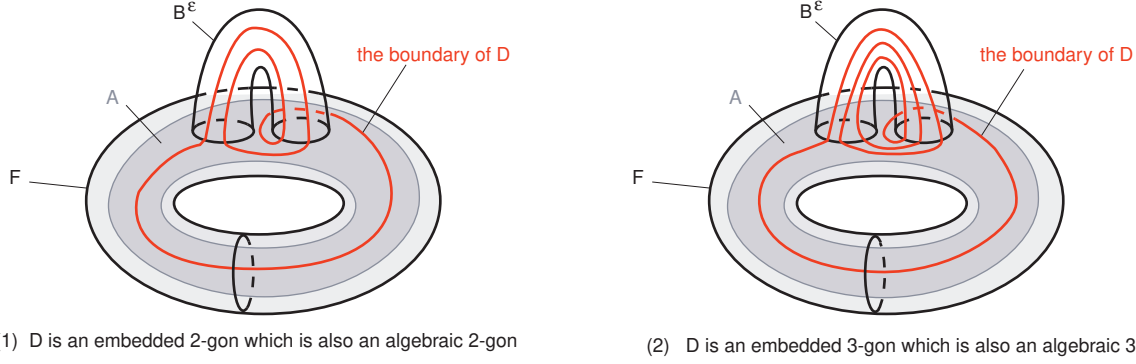

FIGURE 35.

Finally suppose that  $n = 3$  and  $D$  is an algebraic monogon. Then we may assume that the edges, denoted  $e_1, e_2, e_3$ , and the corners, denoted  $u, v, w$ , of  $D$  are as shown in Figure 36(1), where an endpoint of an edge (or a corner) of  $D$  is labeled 1 or 2 if it lies in  $b_1$  or  $b_2$ . For each of  $i = 1, 2$ , the ‘loop’  $\widehat{b}_i \cup e_i$  cannot be contained in a disk in  $\widehat{F}$ , for otherwise  $(D, \partial D) \subset (X^\epsilon, \partial X^\epsilon)$  can be isotoped into an embedded monogon, contradicting part (1) of the lemma. Hence the two loops  $\widehat{b}_1 \cup e_1$  and  $\widehat{b}_2 \cup e_2$  are essential and parallel in  $\widehat{F}$ . So the edges of  $D$  are contained in the annulus  $A$  shown in Figure 36 (2).

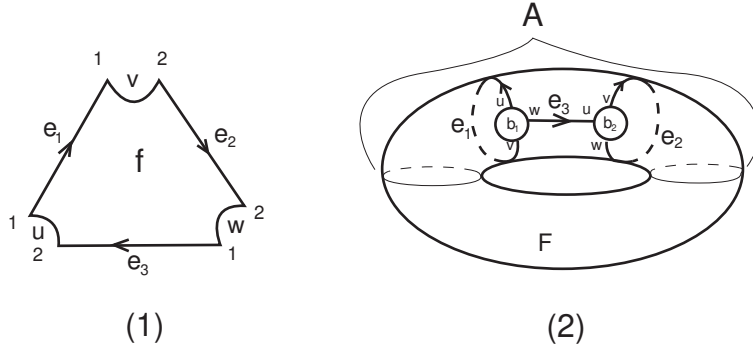

FIGURE 36.

Now define  $Q$  to be a regular neighbourhood of  $A \cup H^\epsilon \cup D$  in  $\widehat{X}^\epsilon$ . Choose a fat base point in  $\widehat{F}$  which contains  $b_1 \cup b_2 \cup e_3$ . Let  $x$  be the element of  $\pi_1(\widehat{X}^\epsilon)$  represented by an essential arc of the annulus  $B^\epsilon$  running from  $b_1$  to  $b_2$  and let  $t$  be the element represented by the edge  $e_1$  oriented as indicated in Figure 36(2). Then  $Q$  has the following fundamental group:

$$\pi_1(Q) = \langle t, x : txtx^{-2} \rangle$$

Note that  $\pi_1(Q)$  injects into  $\pi_1(\widehat{X}^\epsilon)$  since the frontier of  $Q$  in  $\widehat{X}^\epsilon$  is an incompressible annulus in  $(\widehat{X}^\epsilon, \widehat{F})$ . Let  $y = tx$ , then  $\pi_1(Q) = \langle x, y : y^2 = x^3 \rangle$  and we see that  $Q$  is homeomorphic to the trefoil knot exterior with the loop  $t$  as a meridian. In particular the loop  $t$  is distance 1 from a regular fibre of  $Q$  in  $\partial Q$ . A more explicit geometric illustration of the situation is given in part (1) of Figure 37, where  $A \times I \cup H^\epsilon$  is a genus two handlebody, the brown loop and the green loop bound two disjoint disks which cut the handle body into a 3-ball, the face  $f$  is attached to



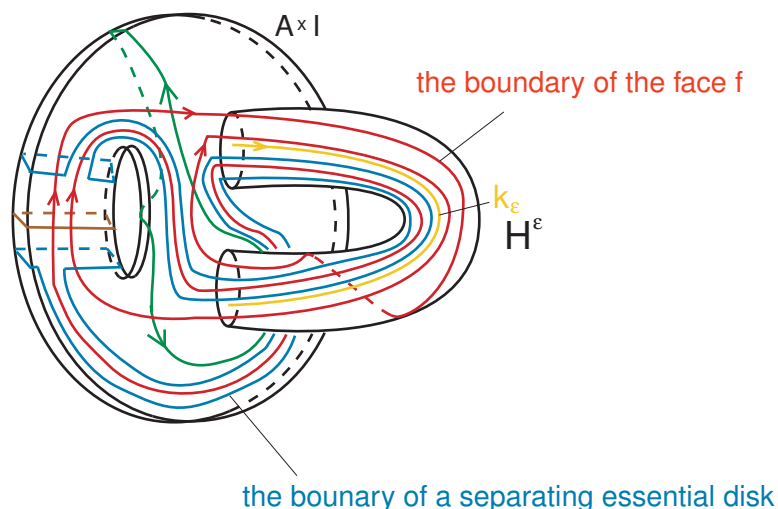

(1)

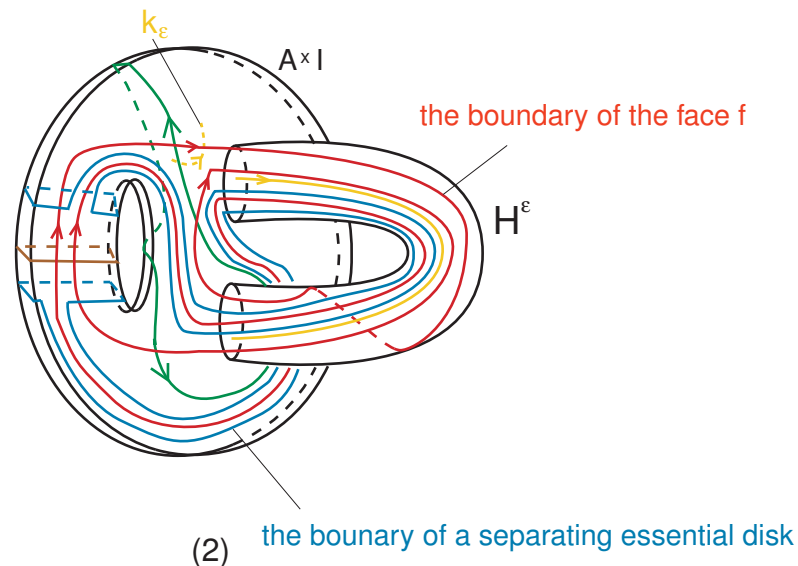

(2)

FIGURE 37.

the handlebody along the red loop which intersects the green loop three times with the same sign and intersects the brown curve twice with the same sign.

In Figure 37, the blue loop is the boundary of an essential separating disk  $D_*$  of the handlebody. The disk  $D_*$  separates the handlebody into two solid tori. Let  $V$  be the one which contains the green loop. The red loop intersects the blue loop twice (with opposite signs). Let  $e$  be the part of the red curve in  $\partial V$  and let  $E = e \times I$  be a regular neighbourhood of  $e$  in  $\partial V - \partial D_*$ . Observe that  $D_* \cup E$  is a vertical essential annulus of  $Q$ . Now one can see from Figure 37 that the arc  $(k_\epsilon, \partial k_\epsilon)$  can be isotoped in  $(Q, \partial Q)$  to lie in a position as shown in part (2) of Figure 37. This completes the proof.  $\diamond$

**Corollary 11.2.** *Suppose that  $t_1^\epsilon = 0$ . If there is a trigon face of  $\Gamma_F$  lying in  $X^\epsilon$  which is an algebraic monogon, then  $\widehat{X}^\epsilon$  is a trefoil exterior.*

*Proof.* Suppose that  $f$  is a trigon face of  $\Gamma_F$  lying in  $X^\epsilon$  which is an algebraic monogon. The hypothesis that  $t_1^\epsilon = 0$  implies that  $\widehat{X}^\epsilon$  admits a Seifert structure with base orbifold a disk with two cone points. We must show that the orders of these cone points are 2 and 3.

Combining Lemma 11.1(1) and the loop theorem with respect to the (mod 2) intersection with the class of  $b_1$  in  $H_1(\partial\widehat{X}^\epsilon)$  ([He, Theorem 4.10]), we see that there is an embedded trigon in  $X^\epsilon$ . If it is an algebraic monogon we are done by Lemma 11.1(3). If it is an algebraic trigon, then the base orbifold of  $\widehat{X}^\epsilon$  has a cone point of order 3 by Lemma 11.1(2). Now apply the loop theorem to  $f$  with respect to the (mod 3) intersection with the class of  $b_1$ . The result is either an embedded trigon which is an algebraic monogon, so we are done, or an embedded bigon which is also an algebraic bigon, in which case the base orbifold of  $\widehat{X}^\epsilon$  has a cone point of order 2 (Lemma 11.1(2)), so we are done.  $\diamond$

## 12. THE PROOF OF THEOREM 1.2 WHEN $F$ SEPARATES BUT IS NOT A SEMI-FIBRE AND

$$t_1^+ + t_1^- > 0$$

The goal of this section is to prove Theorem 1.2 in the case that  $F$  separates, is not a semi-fibre, and  $t_1^+ + t_1^- > 0$ . More particularly we show:

**Proposition 12.1.** *Suppose that Assumptions 4.3 and 9.2 hold,  $F$  is separating, and  $t_1^+ + t_1^- > 0$ . Then  $\Delta(\alpha, \beta) \leq 4$ .*

We begin with a lemma.

**Lemma 12.2.** *Suppose that  $t_1^+ + t_1^- > 0$ .*

(1) *If  $t_1^+ + t_1^- > 2$ , then  $\Delta(\alpha, \beta) \leq \begin{cases} 2 & \text{if } M(\alpha) \text{ is very small} \\ 3 & \text{otherwise} \end{cases}$*

(2) *Suppose that  $t_1^+ + t_1^- = 2$ , say  $t_1^\epsilon = 2$  and  $t_1^{-\epsilon} = 0$ .*

(a)  *$X^\epsilon$  admits no essential bigons or embedded trigons which are algebraic trigons.*

(b)  $\Delta(\alpha, \beta) \leq \begin{cases} 5 & \text{if } M(\alpha) \text{ is very small} \\ 6 & \text{otherwise} \end{cases}$

(c) *If  $\Delta(\alpha, \beta) \geq \begin{cases} 4 & \text{if } M(\alpha) \text{ is very small} \\ 5 & \text{otherwise} \end{cases}$ , then  $\widehat{X}^\epsilon$  is the union of a trefoil exterior  $Q$  and a solid torus  $U$  along an annulus  $A_\epsilon = \partial Q \cap \partial U$  which is meridional in  $Q$  and of winding number 2 or more in  $U$ .*

**Proof.** Recall from §9 that  $t_1^+$  and  $t_1^-$  are even integers satisfying  $0 \leq t_1^+, t_1^- \leq 2$ . If  $t_1^+ = t_1^- = 2$ , then  $\check{\Phi}_1^+ = \check{\Phi}_1^-$  is a collar on  $\partial F$ , so there are no essential homotopies in  $(M, F)$  of positive

length of large maps to  $F$ . Hence no pair of distinct edges in  $\Gamma_F$  are parallel ([BGZ2, Proposition 11.3]) and therefore the valency of each vertex of  $\bar{\Gamma}_F$  equals that of the vertices of  $\Gamma_F$ , which is  $2\Delta(\alpha, \beta)$ . If  $M(\alpha)$  is very small,  $\bar{\Gamma}_F$  is contained in a disk so that there is a vertex of valency at most 5. Hence  $\Delta(\alpha, \beta) \leq 2$ . Otherwise  $\bar{\Gamma}_F$  is contained in a torus and so has a vertex of valency at most 6. Thus  $\Delta(\alpha, \beta) \leq 3$ , which proves (1).

Assume next that  $t_1^+ + t_1^- = 2$ . Without loss of generality we can suppose that  $t_1^+ = 2$  and  $t_1^- = 0$ . Since  $t_1^+ = 2$ ,  $\check{\Phi}_1^+$  is a collar on  $\partial F$ , so there are no essential homotopies of large maps in  $(X^+, F)$ . Hence there are no essential bigons in  $X^+$ . Lemma 11.1(2) implies that there are no embedded trigons in  $X^+$  which are algebraic trigons, so (2)(a) holds.

Since there are no essential bigons in  $X^+$ , all bigon faces of  $\Gamma_F$  lie in  $X^-$ . It follows that the weight of each edge of  $\bar{\Gamma}_F$  is no more than 2. Since the valency of any vertex of  $\Gamma_F$  is  $2\Delta(\alpha, \beta)$  it follows that  $\Delta(\alpha, \beta)$  is bounded above by the valency of any vertex  $v$  of  $\bar{\Gamma}_F$  with equality if and only if the weight of each edge incident to  $v$  is 2. When the immersion surface  $Y$  containing  $\bar{\Gamma}_F$  is a torus (cf. (9.0.1)), there is a vertex of  $\bar{\Gamma}_F$  of valency 6 or fewer, so  $\Delta(\alpha, \beta) \leq 6$ . When it is a disk, for instance when  $M(\alpha)$  is very small, there is a vertex of  $\bar{\Gamma}_F$  of valency 5 or fewer, so  $\Delta(\alpha, \beta) \leq 5$ . Thus (2)(b) holds.

Now assume that the hypotheses of (2)(c) hold. Then from the previous paragraph we see that for each vertex  $v$  of  $\bar{\Gamma}_F$ ,

$$(12.0.1) \quad \text{valency}_{\bar{\Gamma}_F}(v) \geq \Delta(\alpha, \beta) \geq \begin{cases} 4 & \text{if } M(\alpha) \text{ is very small} \\ 5 & \text{otherwise} \end{cases}$$

**Claim 12.3.**  $\Gamma_F$  has a trigon face  $f$  which lies in  $X^+$ .

*Proof of Claim 12.3.* Let  $\varphi_j(v)$  denote the number of corners of  $j$ -gons incident to a vertex  $v$  of  $\Gamma_F$  and set

$$\mu(v) = \varphi_2(v) + \frac{\varphi_3(v)}{3}$$

If there is a vertex  $v$  of  $\Gamma_F$  such that  $\mu(v) > 2\Delta(\alpha, \beta) - 4$ , then our hypotheses combine with [BGZ2, Proposition 12.2 (1)] to show that either  $v$  has valency 4 and  $\varphi_3(v) \geq 1$  or  $v$  has valency 5 and  $\varphi_3(v) \geq 4$ . In either case, our assumed lower bound on  $\Delta(\alpha, \beta)$  implies that  $\text{valency}_{\bar{\Gamma}_F}(v) = \Delta(\alpha, \beta)$ . But as we remarked above, this implies that each edge of  $\bar{\Gamma}_F$  incident to  $v$  has weight 2. This implies that each of the faces of  $\bar{\Gamma}_F$  incident to  $v$  lie in  $X^+$ . In particular, the fact that  $\varphi_3(v) > 0$  implies that there is a trigon face of  $\Gamma_F$  lying in  $X^+$ .

Assume next that  $\mu(v) \leq 2\Delta(\alpha, \beta) - 4$  for each  $v$ . Then Corollary 12.4 of [BGZ2] implies that the immersion surface is a torus and  $\mu(v) = 2\Delta(\alpha, \beta) - 4$  for each  $v$ . Proposition 12.2 of [BGZ2] then implies that each vertex of  $\bar{\Gamma}_F$  has valency 5 or 6.

If  $\Delta(\alpha, \beta) = 6$  then each vertex has valency 6, each edge of  $\bar{\Gamma}_F$  has weight 2, and [BGZ2, Proposition 12.2] implies that each face of  $\bar{\Gamma}_F$  is a trigon. Thus  $\bar{\Gamma}_F$  is a hexagonal triangulation and any of its faces can serve as  $f$ .

Finally suppose that  $\Delta(\alpha, \beta) = 5$ . If there is a vertex  $v$  of valency 5 the edges of  $\bar{\Gamma}_F$  incident to  $v$  have weight 2 and  $\varphi_3(v) = 3$  ([BGZ2, Proposition 12.2]), so we are done. If all vertices of  $\bar{\Gamma}_F$  have valency 6, then all its faces are trigons and each vertex is incident to exactly four edges of weight 2, from which the existence of  $f$  follows. This completes the proof of Claim 12.3  $\diamond$

Apply the loop theorem to replace a trigon face  $f$  of  $\Gamma_F$  lying in  $X^+$  by an embedded monogon, bigon or trigon  $(D, \partial D) \subset (X^+, \partial X^+)$ , with each edge of  $D$  an essential arc in  $(F, \partial F)$ . Lemma 11.1(1) shows that  $D$  is not a monogon while as we noted above, the condition that  $t_1^+ = 2$  implies that it is not a bigon. Thus it is a trigon. Lemma 11.1(2) shows that it is an algebraic monogon.

According to Lemma 11.1(3), there is an incompressible separating annulus  $(A_+, \partial A_+) \subset (X^+, F)$  which is the frontier of a trefoil knot exterior  $Q \subset \hat{X}^+$  such that

- (a)  $Q \cap \hat{F}$  is an  $\hat{F}$ -essential annulus whose slope on  $\partial Q$  is the meridional slope of  $Q$ ;
- (b) if  $k_+$  is a core arc of the handle  $H^+$ , then  $(k_+, \partial k_+)$  can be isotoped in  $(Q, \partial Q)$  to lie as a core arc of an essential vertical annulus of  $Q$ .

If  $A_+$  is inessential in  $(X^+, F)$ , then  $Q$  is isotopic to  $\hat{X}^+$  in  $M(\beta)$ . But then, as in the proof of Lemma 11.1(2),  $t_1^+ = 0$ , which is a contradiction. Thus  $A_+$  is essential in  $(X^+, F)$ . On the other hand,  $A_+ \cup (F \setminus Q \cap F)$  is a separating torus in  $X^+ \subset M$  which contains an  $\hat{F}$ -essential annulus. Thus it bounds a solid torus  $U \subset X^+$  such that  $U \cap Q = A_+$  and  $A_+$  has winding number 2 or more in  $U$ . It follows that  $\hat{X}^+$  is the union of a trefoil exterior with a cable space in such a way that the cable slope is identified with the meridional slope of the trefoil. This completes the proof of Lemma 12.2.  $\diamond$

**Lemma 12.4.** *Suppose that Assumptions 4.3 and 9.2 hold,  $F$  separates,  $t_1^+ = 2, t_1^- = 0$ , and*

$$\Delta(\alpha, \beta) \geq \begin{cases} 4 & \text{if } M(\alpha) \text{ is very small} \\ 5 & \text{otherwise} \end{cases}$$

*If  $f$  is a trigon face of  $\Gamma_F$  contained in  $X^+$ , then there is a homotopy  $H : Y \times I \rightarrow M(\alpha)$  of  $h$  to a new immersion  $h'$  satisfying*

- $H$  has support in an arbitrarily small neighbourhood in  $Y$  of a compact subset of  $f$  disjoint from its corners;
- $(h')^{-1}(F) = h^{-1}(F)$ ;
- $h'(f) \subset Q$  where  $Q \subset \hat{X}^+$  is the trefoil exterior described in Lemma 12.2(2).

*Proof.* Lemmas 11.1(3) and 12.2(3) imply that

- $\hat{X}^+$  is the union of a trefoil exterior  $Q$  and a solid torus  $U$  along an essential annulus

$$(A_+, \partial A_+) = (\partial Q \cap \partial U, \partial Q \cap \partial U \cap F)$$

which is meridional in  $\partial Q$  and of winding number 2 or more in  $U$ ;

- $Q \cap \hat{F}$  is an  $\hat{F}$ -essential annulus  $A$  containing  $\partial F$  and  $H^+ \subset Q - A_+$ ;

- $U \cap F$  is an  $\widehat{F}$ -essential annulus  $E$ .

First homotope  $h$ , preserving  $h^{-1}(F)$ , in a small neighbourhood of  $f$  in  $Y$  disjoint from its corners so that  $h|_f$  is transverse to  $A_+$ . A loop component of  $f \cap h^{-1}(A_+)$  lies in  $\text{int}(f) \subset \text{int}(X^+)$  and so as  $\pi_2(Q, A_+) = \pi_2(U, A_+) = 0$ , any such component could be removed by a homotopy with support in the interior of  $f$ . In particular, the homotopy is fixed on  $h^{-1}(F)$ .

Next suppose there is an arc component of  $f \cap h^{-1}(A_+)$  whose end-points lie on an edge of  $f$ . Let  $a$  be such an arc which is outermost in  $f$  and  $D_0$  a disk in  $f$  whose boundary consists of  $a$  and an arc  $b$  in the edge of  $f$  containing  $\partial a$ . Then  $h|_{(D_0, a \cup b)}$  represents an element of  $\pi_2(Q, \partial Q)$  or  $\pi_2(U, \partial U)$  which is necessarily zero. To see why the latter holds, note that the long exact homotopy sequence of the pair  $(Q, \partial Q)$  shows that  $\pi_2(Q, \partial Q) = 0$  while that of  $(U, \partial U)$  yields a short exact sequence of abelian groups

$$0 \rightarrow \pi_2(U, \partial U) \xrightarrow{\partial} \pi_1(\partial U) \rightarrow \pi_1(U) \rightarrow 0,$$

from which we see that  $\pi_2(U, \partial U) \cong \mathbb{Z}$  is generated by a meridional disk of  $U$ .

Suppose that  $h|_{(D_0, a \cup b)}$  represents a non-zero homotopy class in its group. Then  $h(D_0) \subset U$  and the fundamental class of  $\partial D_0$  is sent by  $h_*$  to a non-zero multiple of the meridional class in  $H_1(\partial U)$ . If  $h(\partial a)$  is contained in a single component of  $\partial A_+$ , then  $h|_{D_0}$  is homotopic to a map  $(D_0, \partial D_0) \rightarrow (U, E)$  and so  $h|_{(D_0, a \cup b)}$  lies in the image of  $0 = \pi_2(U, E) \rightarrow \pi_2(U, \partial U)$ , a contradiction. Thus the two points of  $\partial a = \partial b$  are sent into distinct components of  $\partial A_+$  by  $h$ . It follows that  $h|_a$  is homotopic (rel  $\partial a$ ) to a transverse arc in  $A_+$  and  $h|_b$  is homotopic (rel  $\partial b = \partial a$ ) to a transverse arc in the annulus  $E$ . But then  $h|_{\partial D_0}$  is homotopic to a simple closed curve in  $\partial U$  which must be meridional. By construction, this curve has algebraic intersection  $\pm 1$  with the core of  $A_+$ . On the other hand, the absolute value of this intersection is the winding number of  $A_+$  in  $U$ , which is therefore 1, a contradiction.

Suppose next that  $h|_{(D_0, a \cup b)}$  represents zero in  $\pi_2(W, \partial W)$  where  $W$  is  $Q$  or  $U$  as the case may be. Then we can remove  $a$  from  $f \cap h^{-1}(A_+)$  by a homotopy preserving  $h^{-1}(F)$  with support in an arbitrarily small neighbourhood of  $D_0$  in  $Y$ . More precisely, the long exact sequence in homotopy of the pair  $(W, \partial W)$  shows that  $h|_{\partial D_0}$  is homotopically trivial in  $\partial W$ . Hence its algebraic intersection with either component of  $\partial A_+$  is zero. It follows that  $\partial b$  is contained in a single component of  $\partial A_+$  and therefore can be homotoped (rel  $\partial b$ ) into that component. Hence we can homotope  $h$ , preserving  $h^{-1}(F)$  and with support in an arbitrarily small neighbourhood of  $b$  in  $Y$  so as to replace  $a$  by a closed component of  $f \cap h^{-1}(A_+)$  contained in the interior of  $f$ . The latter can be removed as in the the first paragraph of this proof.

Finally suppose that there is an arc component of  $f \cap h^{-1}(A_+)$  whose end-points lie on distinct edges of  $f$ . Choose a cornermost such arc  $a$ . Then  $a$  cobounds a disk  $D_0$  in  $f$  with arcs  $b, c, d$  where  $h(D_0) \subset Q$ ,  $h(b \cup d) \subset A$ ,  $h(c)$  runs once over the annulus  $B^+$ , and the arcs are oriented so that the product  $a * b * c * d$  is well-defined and represents a fundamental class of  $\partial D_0$ .

Choose the base point for  $\pi_1(Q)$  to be  $p_0 = h(d \cap a) \in A_+ \cap F \subset A$  and recall the presentation  $\pi_1(Q; p_0) = \langle t, x : txtx^{-2} \rangle$  described above. By construction, we can suppose that  $t \in \pi_1(A; p_0) \leq \pi_1(Q; p_0)$ . On the other hand,  $x$  may be assumed to be represented

by  $h(d)^{-1} * h(c)^{-1} * \gamma$  where  $\gamma$  is a path in  $A$  from  $h(b \cap c)$  to  $h(a \cap d)$ . Then the existence of the disk  $D_0$  implies that  $h(d)^{-1} * h(c)^{-1} * \gamma \simeq h(a) * h(b) * \gamma \text{ rel } \{0, 1\}$ . But then  $x = [h(a) * h(b) * \gamma] \in \pi_1(\partial Q; p_0) \leq \pi_1(Q; p_0)$  which would imply that  $\pi_1(\partial Q; p_0) \rightarrow \pi_1(Q; p_0)$  is surjective, a contradiction. Thus this case does not arise, which completes the proof of the lemma.  $\diamond$

**Lemma 12.5.** *Suppose that Assumptions 4.3 and 9.2 hold,  $F$  is separating,  $t_1^+ = 2, t_1^- = 0$ , and*

$$\Delta(\alpha, \beta) \geq \begin{cases} 4 & \text{if } M(\alpha) \text{ is very small} \\ 5 & \text{otherwise} \end{cases}$$

*Then  $\bar{\Gamma}_F$  contains no pair of trigon faces  $f_1, f_2$  which share a positive edge  $e$  of weight 2.*

*Proof.* We use the notation from the previous lemma and note that it implies that we can assume  $h(f_1) \cup h(f_2) \subset Q$ .

Let  $e_i$  be the edge of  $f_i$  parallel to  $e$  and let  $R$  be the bigon of  $\Gamma_F$  cobounded by  $e_1$  and  $e_2$ . Since  $e$  is a positive edge,  $R$  is an algebraic bigon. By construction,  $\partial R \subset \partial X^- - E$ . Applying the loop theorem with respect to the (mod 3) intersection with  $b_1$  yields an embedded  $n$ -gon  $D$  with boundary contained in  $\partial X^- - E$  where  $n \leq 2$  such that  $D$  is an algebraic  $m$ -gon for some  $m \not\equiv 0 \pmod{3}$ . Lemma 11.1(1) shows that  $n = 2$  and so  $m = 2$  as well.

There is a disk  $D'$  properly embedded in  $H^-$  which contains  $k_- = K_\beta \cap H^-$  as a properly embedded arc and which intersects  $B^-$  in the two arcs  $D \cap B^-$ . Then  $D \cup D'$  is a Möbius band properly embedded in  $\hat{X}^-$  which contains  $k_-$  as a properly embedded essential arc. It has a solid torus regular neighbourhood,  $V$  say, which intersects  $\hat{F}$  in an essential annulus  $E' \subset \hat{F} - E$  whose interior contains  $\partial F$  and which has winding number 2 in  $V$ . Up to isotopy, we can assume that  $\partial E' = \partial A_+$ .

The annulus  $A_- = \partial V \setminus E'$  is properly embedded and separating in  $X^-$  and as  $t_1^- = 0$ , it cobounds a solid torus  $V' \subset X^-$  with  $E$  in which  $A_-$  has winding number two or more. But then  $U \cup V$  would be a Seifert manifold over the 2-disk with two cone points which is contained in the hyperbolic manifold  $M$ , which is impossible. Thus  $\bar{\Gamma}_F$  contains no pair of trigon faces  $f_1, f_2$  which share a positive edge  $e$ .  $\diamond$

**Lemma 12.6.** *Suppose that Assumptions 4.3 and 9.2 hold,  $F$  is separating,  $t_1^+ = 2, t_1^- = 0$ , and*

$$\Delta(\alpha, \beta) \geq \begin{cases} 4 & \text{if } M(\alpha) \text{ is very small} \\ 5 & \text{otherwise} \end{cases}$$

*Then  $\Gamma_{\bar{F}}$  contains no pair of trigon faces  $f_1, f_2$  which share a negative edge  $e$  of weight 2.*

*Proof.* We use the notation of Lemma 12.4 and note that it implies that we can assume  $h(f_1) \cup h(f_2) \subset Q$ .

Let  $e_i$  be the edge of  $f_i$  parallel to  $e$  and let  $R$  be the bigon of  $\Gamma_F$  cobounded by  $e_1$  and  $e_2$ . Let  $\sigma_i$  be the essential loop  $h|(e_i, \partial e_i) : (e_i, \partial e_i) \rightarrow (F, \partial F)$ . Without loss of generality we can

assume that  $b_i$  is the origin of  $\sigma_i$ . We can also assume that the images of  $\sigma_1, \sigma_2$  are contained in  $\hat{\Phi}_1^-$ .

If  $\sigma_i$  is  $\hat{F}$ -inessential, then the relation associated to  $f_i$  (cf. §15 of [BGZ2]) implies that the class of  $x \in \pi_1(Q) \leq \pi_1(\hat{X}^+)$  (cf. the proof of Lemma 11.1(3)) is peripheral (cf. [BGZ2, Corollary 15.2]), which is false. Thus  $\sigma_1$  and  $\sigma_2$  represent  $\hat{F}$ -essential loops and therefore  $\partial R$  is an essential loop in  $\partial X^- - E$ . The loop theorem produces an embedded bigon  $(D, \partial D) \subset (X^-, \partial X^-)$ . The proof of Lemma 12.5 shows that  $D$  is not an algebraic bigon, so intersects  $F$  in disjoint loops, one based at  $b_1$  and one at  $b_2$ . Since  $F$  is incompressible, each of the loops is  $\hat{F}$ -essential and thus is isotopic in  $\hat{F}$  into  $\partial E$ .

The union of  $D$  and an appropriate choice of a product region in  $B^-$  between the two arcs of  $D \cap B^-$  yields an embedded annulus  $A^-$  in  $X^-$  whose boundary is contained in  $A$  and is isotopic in  $A$  to  $\partial A = \partial E$ . After an isotopy in  $X^-$ , we can suppose that  $\partial A_- = \partial E$ . Since  $(k_-, \partial k_-)$  is isotopic in  $(\hat{X}^-, \hat{F})$  into the chosen product region in  $B^-$ ,  $A_-$  is an essential annulus in  $X^-$ .

If  $A_-$  is non-separating in  $\hat{X}^-$ , then  $\hat{X}^-$  is a twisted  $I$ -bundle over the Klein bottle and  $A_- \cup A_+$  is an embedded non-separating Klein bottle or torus in the hyperbolic manifold  $M$ , which is impossible. But if  $A_-$  is separating in  $\hat{X}^-$ , it splits the latter into two solid tori in each of which  $A_-$  has winding number 2. One of these solid tori,  $V$  say, is contained in  $X^-$  and has boundary  $A_- \cup E$ . Then  $V \cup U$  is a Seifert manifold over a 2-disk with two cone points contained in  $M$ , which is impossible.  $\diamond$

*Proof of Proposition 12.1.* Suppose otherwise that  $\Delta(\alpha, \beta) \geq 5$  and, without loss of generality, that  $t_1^+ = 2, t_1^- = 0$ . We saw in the proof of Lemma 12.2(2) that the condition  $t_1^+ = 2$  implies that each edge of  $\bar{\Gamma}_F$  has weight at most 2 and each vertex has valency at least 5. Further, if  $v$  is a vertex of  $\bar{\Gamma}_F$ , then  $\text{valency}_{\bar{\Gamma}_F}(v) \geq \Delta(\alpha, \beta)$  with equality if and only if each edge incident to  $v$  has weight 2.

Corollary 12.4 of [BGZ2] shows that there is a vertex  $v$  of  $\Gamma_F$  for which  $\mu(v) \geq 2\Delta(\alpha, \beta) - 4$ . Proposition 12.2 of that paper then shows that  $5 \leq \text{valency}_{\bar{\Gamma}_F}(v) \leq 6$ . Hence if  $k$  is the number of weight 2 edges incident to  $v$ , then

$$10 \leq 2\Delta(\alpha, \beta) = \text{valency}_{\Gamma_F}(v) = 2k + (\text{valency}_{\bar{\Gamma}_F}(v) - k) \leq 6 + k$$

Hence  $k \geq 4$ .

If  $\mu(v) > 2\Delta(\alpha, \beta) - 4$ , Proposition 12.2 of [BGZ2] shows that  $v$  has valency 5 with at least four trigon faces incident to it, two of which share a weight 2 edge as  $k \geq 4$ , contrary to Lemmas 12.5 and 12.6.

On the other hand if  $\mu(v) = 2\Delta(\alpha, \beta) - 4$ , then Proposition 12.2 of [BGZ2] shows that  $v$  has valency 5 with at least four trigon faces incident to it or 6 with six trigon faces incident to it. In either case the fact that  $k \geq 4$  implies that there are a pair of trigons incident to  $v$  which share a weight 2 edge, contrary to Lemmas 12.5 and 12.6. This final contradiction shows that  $\Delta(\alpha, \beta) \leq 4$ .  $\diamond$

13. BACKGROUND FOR THE PROOF OF THEOREM 1.2 WHEN  $F$  SEPARATES AND  $t_1^+ = t_1^- = 0$ 

Throughout the remainder of the paper we assume that  $F$  separates, is not a semi-fibre, and  $t_1^+ = t_1^- = 0$ .

Recall that when  $t_1^+ = t_1^- = 0$ ,  $\widehat{X}^+$  and  $\widehat{X}^-$  are Seifert fibred over the disk with two cone points [BGZ2, Proposition 7.4]. Further, if  $\widehat{X}^\epsilon$  has base orbifold  $D^2(p_\epsilon, q_\epsilon)$ ,  $2 \leq p_\epsilon \leq q_\epsilon$ , then

- $2 < p_\epsilon \leq q_\epsilon$  if and only if  $\widehat{\Phi}_1^\epsilon$  is the union of two once-punctured  $\widehat{F}$ -essential annuli which are vertical in  $\widehat{X}^\epsilon$ .
- $2 = p_\epsilon < q_\epsilon$  if and only if  $\widehat{\Phi}_1^\epsilon$  is a twice-punctured  $\widehat{F}$ -essential annulus which is vertical in  $\widehat{X}^\epsilon$ .
- $p_\epsilon = q_\epsilon = 2$  if and only if  $X^\epsilon$  is a twisted  $I$  bundle.

Without loss of generality, we assume that  $(p_-, q_-) \leq (p_+, q_+)$  lexicographically. That is,

- $p_- \leq p_+$  and if  $p_- = p_+$ , then  $q_- \leq q_+$ .

Since  $F$  is not a semi-fibre,  $(p_+, q_+) \neq (2, 2)$ . An analysis of the possible essential tori in  $M(\beta)$  then shows that it is not the union of two twisted  $I$ -bundles over the Klein bottle (cf. [BGZ2, Corollary 7.6]). Further, under the added assumption that  $X^-$  is not a twisted  $I$ -bundle,  $(p_-, q_-) \neq (2, 2)$ , if  $M(\beta)$  contains a Klein bottle then  $M(\beta)$  is Seifert with base orbifold  $S^2(p_+, q_+, p_-, q_-)$  where  $p_+ = p_- = 2$ .

**13.1. The case that  $M(\beta)$  is Seifert.** Let  $\phi_\epsilon$  denote the slope on  $\widehat{F}$  of a Seifert fibre of  $\widehat{X}^\epsilon$  corresponding to the Seifert structure whose base orbifold is  $D^2(p_\epsilon, q_\epsilon)$  and set

$$d = \Delta(\phi_+, \phi_-).$$

When  $\widehat{X}^-$  is a twisted  $I$ -bundle over the Klein bottle we let  $\phi'_-$  denote the slope on  $\widehat{F}$  of a Seifert fibre of  $\widehat{X}^-$  corresponding to the Seifert structure whose base orbifold is a Möbius band. It is well-known that

$$\Delta(\phi_-, \phi'_-) = 1.$$

Set

$$d' = \Delta(\phi_+, \phi'_-)$$

and orient  $\phi_+, \phi_-$ , and  $\phi'_-$  so that

$$d = \phi_+ \cdot \phi_- \quad \text{and} \quad d' = \phi_+ \cdot \phi'_-.$$

If  $d = 0$  or  $X^-$  is a twisted  $I$ -bundle and  $d' = 0$ , then there are Seifert fibre structures on  $\widehat{X}^+$  and  $\widehat{X}^-$  which piece together to give one on  $M(\beta)$ .

Conversely, if  $M(\beta)$  is a Seifert fibre space, the separating essential torus  $\widehat{F}$  cannot be horizontal as this would imply that  $M(\beta)$  has non-orientable Euclidean base orbifold  $P^2(2, 2)$  or the Klein bottle  $K$ . In either case,  $M(\beta)$  would be a union of two twisted  $I$ -bundles over the Klein bottle, contrary to what we noted above. Thus  $\widehat{F}$  is vertical and this implies that there are Seifert



structures on  $\widehat{X}^+$  and  $\widehat{X}^-$  which coincide on  $\widehat{F}$ . It follows that either  $\phi_+ = \phi_-$  (i.e.  $d = 0$ ) or  $\widehat{X}^-$  is a twisted  $I$ -bundle and  $\phi_+ = \phi'_-$  (i.e.  $d' = 0$ ).

**Proposition 13.1.** *Suppose that Assumptions 4.3 and 9.2 hold,  $F$  is separating but not a semi-fibre, and  $t_1^+ = t_1^- = 0$ . If  $d = 0$ , then  $\Delta(\alpha, \beta) \leq 1$ . In particular, Theorem 1.2 holds.*

*Proof.* When  $d = 0$ ,  $M(\beta)$  is Seifert fibred with base orbifold  $S^2(p_+, q_+, p_-, q_-)$ . Since  $(p_+, q_+) \neq (2, 2)$ ,  $S^2(p_+, q_+, p_-, q_-)$  is a hyperbolic 2-orbifold and so [BGZ1, Theorem 1.7] implies that  $\beta$  is a singular slope of a closed essential surface in  $M$ . Consequently,  $\Delta(\alpha, \beta) \leq 1$  by Proposition 4.1.  $\diamond$

**Proposition 13.2.** *Suppose that Assumptions 4.3 and 9.2 hold,  $F$  is separating but not a semi-fibre, and  $t_1^+ = t_1^- = 0$ ,  $p_- = q_- = 2$  (i.e.  $X^-$  is a twisted  $I$ -bundle),  $d' = 0$ , and  $\Delta(\alpha, \beta)$  is even. Then  $\Delta(\alpha, \beta) \leq 2$ . In particular, Theorem 1.2 holds.*

*Proof.* By assumption,  $X^-$  is a twisted  $I$ -bundle over a once-punctured Klein bottle and hence there is a 2-fold cover of  $\widetilde{M} \rightarrow M$  which restricts to the cover  $F \times I \rightarrow X^-$  on the  $-$ -side of  $F$  and the trivial double cover on the  $+$ -side of  $F$ . Since  $m \equiv 2 \pmod{4}$  the boundary of  $\widetilde{M}$  is connected.

Now  $\beta$  lifts to a slope  $\beta'$  on  $\partial\widetilde{M}$  whose associated filling admits a 2-fold cover  $\widetilde{M}(\beta') \rightarrow M(\beta)$ . Since  $d' = 0$ ,  $M(\beta)$  admits a Seifert fibre structure with base orbifold  $P^2(p_+, q_+)$  and the reader will verify that  $\widetilde{M}(\beta')$  admits a Seifert fibre structure with base orbifold  $S^2(p_+, q_+, p_+, q_+) \neq S^2(2, 2, 2, 2)$ . Hence  $\beta'$  is a singular slope of some closed essential surface  $S \subseteq \widetilde{M}$  ([BGZ1, Theorem 1.7]).

Since the distance of  $\alpha$  to  $\beta$  is even,  $\alpha$  also lifts to a slope  $\alpha'$  on  $\partial\widetilde{M}$  with the associated filling a 2-fold cover of  $M(\alpha)$ . Hence  $\widetilde{M}(\alpha')$  admits a Seifert fibre structure with base orbifold a 2-sphere with three or four cone points.

Suppose that  $\Delta(\alpha, \beta) \geq 4$ . It's easy to see that the distance between  $\alpha'$  and  $\beta'$  is  $\Delta(\alpha, \beta)/2 \geq 2$ . Hence as  $\beta'$  is a singular slope for  $S$ ,  $S$  is incompressible in  $\widetilde{M}(\alpha')$ . As  $\widetilde{M}$  is hyperbolic,  $S$  cannot be a torus and therefore must be horizontal in  $\widetilde{M}(\alpha')$ . It cannot be separating as the base orbifold of  $\widetilde{M}(\alpha')$  is orientable. Thus it is non-separating. But then Proposition 4.1 implies the distance between  $\alpha'$  and  $\beta'$  is at most 1, and therefore  $\Delta(\alpha, \beta) = 2\Delta(\alpha', \beta') \leq 2$ , a contradiction. Thus  $\Delta(\alpha, \beta) \leq 3$ , and as this distance is even,  $\Delta(\alpha, \beta) \leq 2$ .  $\diamond$

### 13.2. Edge weights.

**Lemma 13.3.** *Suppose that  $t_1^+ = t_1^- = 0$  and  $\Delta(\alpha, \beta) > 3$ .*

- (1) *If  $X^-$  is not a twisted  $I$ -bundle, then,*
  - (a) *the edges of  $\overline{\Gamma}_F$  have weight at most 3 and a negative edge of weight 3 determines an  $\widehat{F}$ -inessential loop;*
  - (b) *if there is an edge of weight 3 then  $p_+ = p_- = 2$ ;*

- (c) a negative edge of  $\bar{\Gamma}_F$  incident to a trigon has weight at most 2, and if 2, then  $d = 1$ .
- (2) If  $X^-$  is a twisted  $I$ -bundle, then the faces of  $\bar{\Gamma}_F$  which lie in  $X^-$  can be assumed to be bigons and its edges can be assumed to have even weight. Further,
- (a) the edges of  $\bar{\Gamma}_F$  have weight at most 4;
- (b) a negative edge of  $\bar{\Gamma}_F$  incident to a trigon has weight at most 2.

*Proof.* (1)(a) Proposition 13.1 shows that  $d \geq 1$ , so when  $X^-$  is not a twisted  $I$ -bundle,  $\dot{\Phi}_2^+ \cong \dot{\Phi}_2^- \cong \dot{\Phi}_1^+ \wedge \dot{\Phi}_1^-$  consists of tight components ([BGZ2, Lemma 9.2]). Hence  $\dot{\Phi}_3^+ = \dot{\Phi}_3^- = \emptyset$  ([BGZ2, Proposition 9.3]), so the weight of each edge is at most 3. Further, any negative edge of weight 3 represents loop contained in a tight component of  $\dot{\Phi}_2^\epsilon$  for some  $\epsilon$ , so is  $\widehat{F}$ -inessential. This proves (1)(a).

For (1)(b), suppose that  $p_\epsilon > 2$ . Then  $\dot{\Phi}_1^\epsilon$  consists of two once-punctured annuli, so each edge of  $\Gamma_F$  which lies in  $\dot{\Phi}_1^\epsilon$  is negative and  $\widehat{F}$ -essential. Thus if an edge  $\bar{e}$  of  $\bar{\Gamma}_F$  has weight 3, it is negative and its lead edge is  $\widehat{F}$ -essential, contrary to (1)(a). Thus  $p_+ = p_- = 2$ .

(1)(c) Let  $\bar{e}$  be a negative edge of  $\bar{\Gamma}_F$  incident to a trigon  $f$  lying in  $X^\epsilon$  and denote by  $e_1$  the edge of  $f$  parallel to  $\bar{e}$ . Then [BGZ2, Corollary 15.2] shows that the loop in  $\widehat{F}$  corresponding to  $e_1$  is  $\widehat{F}$ -essential. If the weight of  $\bar{e}$  is 3,  $\tau_{-\epsilon}(h(e_1))$  is an  $\widehat{F}$ -essential loop contained in  $\dot{\Phi}_1^+$  and in  $\dot{\Phi}_1^-$ . But then  $\phi_+ = \phi_-$ , contrary to the assumption that  $d \neq 0$ . Hence the weight of  $\bar{e}$  can be at most 2, which proves the first part of (1)(c).

For the second part of (1)(c), suppose that  $\bar{e}$  has weight 2 and recall from the proof of Lemma 11.1(3) that  $\pi_1(\widehat{X}^\epsilon)$  is generated by  $\pi_1(\widehat{F})$  and a class  $x$  represented by a loop which is the concatenation of an essential arc in  $B^\epsilon$  and a path in  $F$ . Let  $\gamma$  denote the class of the loop  $h(e_1)$  in  $\pi_1(\widehat{X}^\epsilon)$ . Since  $X^{-\epsilon}$  is not a twisted  $I$ -bundle and the weight of  $\bar{e}$  is 2,  $\gamma = \phi_{-\epsilon}^k$  for some integer  $k$ . The relation associated to  $f$  (cf. §15 of [BGZ2]) shows that the image  $x$  in  $\pi_1(\widehat{X}^\epsilon)/\langle\langle\gamma\rangle\rangle = \pi_1(\widehat{X}^\epsilon)/\langle\langle\phi_{-\epsilon}^k\rangle\rangle$  is contained in the image of  $\pi_1(\widehat{F})$ , so  $\pi_1(\widehat{X}^\epsilon)/\langle\langle\phi_{-\epsilon}^k\rangle\rangle$  is abelian. On the other hand,  $\pi_1(\widehat{X}^\epsilon)/\langle\langle\phi_{-\epsilon}^k\rangle\rangle$  admits the presentation  $\langle u, v : u^{p_\epsilon}, v^{q_\epsilon}, (uv)^{kd} \rangle$  which is abelian only if  $kd = \pm 1$ . Thus  $k = \pm 1$  and  $d = 1$ .

(2) If  $X^-$  is a twisted  $I$ -bundle, its base is a once-punctured Klein bottle  $K_0$ . We use  $K_0$  to construct an intersection graph  $\Gamma_{K_0}$  as in §2 of [BCSZ1]. Though surfaces were assumed orientable in [BCSZ1], the construction goes through in our context to yield a graph  $\Gamma_{K_0}$  such that the image of each of its edges in  $K_0$  is an essential path in  $(K_0, \partial K_0)$ . There is an associated intersection graph  $\Gamma_F$  obtained by doubling each edge of  $\Gamma_{K_0}$ . In this case, each face of  $\Gamma_F$  contained in  $X^-$  is a bigon and each edge of  $\bar{\Gamma}_F$  has even weight.

(2)(a) If the weight of an edge  $\bar{e}$  is larger than 4, then [BGZ2, Corollary 11.4 and Proposition 9.4(3)] show that the weight of  $\bar{e}$  is 6,  $\dot{\Phi}_1^+$  is an  $\widehat{F}$ -essential twice-punctured annulus,  $\dot{\Phi}_3^+$  is the union of two  $\widehat{F}$ -essential once-punctured annuli, and  $\phi_+ = \phi_-$  so that  $M(\beta)$  is Seifert fibred with base orbifold  $P^2(2, n)$  for some  $n \geq 3$ . Let  $e_1, \dots, e_6$  be the parallel successive edges

represented by  $\bar{e}$ . Since  $e_2$  lies in  $\dot{\Phi}_4^+ = \dot{\Phi}_3^+$ ,  $\bar{e}$  is a negative edge representing an  $\widehat{F}$ -essential loop.

Let  $R$  be the bigon face between  $e_3$  and  $e_4$ , which lie in  $\dot{\Phi}_1^+$ , and apply the loop theorem to the singular disk  $h|_R : (R, \partial R) \rightarrow (X^-, \partial X^-)$  to obtain an embedded disk  $(D, \partial D) \subset (X^-, \partial X^-)$ , which must be a bigon whose two edges  $d_1$  and  $d_2$  are contained in  $\dot{\Phi}_1^+$  and two corners of  $D$  are essential arcs in the annulus  $B^-$ .

If  $D$  is an algebraic bigon, then the union of  $D$  and a product region in  $B^-$  between the two corners of  $D$  yields an embedded Möbius band in  $X^-$  whose boundary has slope  $\phi_-$  (since the boundary of any embedded Möbius band in  $\widehat{X}^-$  has slope  $\phi_-$ ). But the boundary of this Möbius band is contained in  $\dot{\Phi}_1^+$  and thus has slope  $\phi_+ = \phi'_-$ . But then  $\phi_- = \phi'_-$ , which is false.

So  $D$  is an algebraic 0-gon. In this case, the union of  $D$  and an appropriate choice of a product region in  $B^-$  between the two corners of  $D$  yields an embedded essential annulus  $A^-$  in  $X^-$  whose boundary is contained in  $\dot{\Phi}_1^+$  and is isotopic to the boundary of the annulus  $\widehat{\Phi}_1^+$ . Since the boundary slope of  $A^-$  in  $\widehat{F}$  is  $\phi_+ = \phi'_-$ ,  $A^-$  is a non-separating annulus in  $\widehat{X}^-$ . On the other hand we know that the boundary of  $\widehat{\Phi}_1^+$  bounds a separating essential annulus  $A^+$  in  $X^+$ . So up to isotopy the two annuli  $A^-$  and  $A^+$  can be pieced together to form a Klein bottle in  $M$ , which contradicts the fact that  $M$  is hyperbolic.

(2)(b) follows as in the proof of [BGZ2, Lemma 19.6].  $\diamond$

**Definition 13.4.** We say that an edge of  $\bar{\Gamma}_F$  has *maximal weight* if its weight is 3 when  $X^-$  is not a twisted  $I$ -bundle and 4 when  $X^-$  is a twisted  $I$ -bundle.

**13.3. The trace of an essential annulus in a face of  $\Gamma_F$ .** In this subsection we assume that  $X^\epsilon$  is not a twisted  $I$ -bundle. In particular,

$$q_\epsilon \geq 3.$$

Up to isotopy, there are two choices for an essential annulus  $A$  properly embedded in  $(X^\epsilon, F)$  which cobounds a solid torus in  $X^\epsilon$  with an  $\widehat{F}$ -essential annulus in  $F$ , one for which  $A$  has winding number  $q_\epsilon \geq 3$  in the solid torus and one for which it has winding number  $p_\epsilon \geq 2$ . Throughout the rest of the paper we use

- $A_\epsilon$  to denote the essential annulus of winding number  $q_\epsilon$ ,  $U$  to denote the associated solid torus,  $E = U \cap F$  to denote the associated  $\widehat{F}$ -essential annulus, and  $c_1, c_2$  to denote the boundary components of  $A_\epsilon$ ;
- $A'_\epsilon$  to denote the essential annulus of winding number  $p_\epsilon$ ,  $V$  to denote the associated solid torus,  $G = V \cap F$  to denote the associated  $\widehat{F}$ -essential annulus, and  $c'_1, c'_2$  to denote the boundary components of  $A'_\epsilon$ .

We can write  $X^\epsilon = U \cup P \cup V$  where  $P$  is the product of a once-punctured annulus with an interval and  $P$  has frontier  $A_\epsilon \cup A'_\epsilon$  in  $X^\epsilon$ . Up to isotopy we have

$$(\dot{\Sigma}_1^\epsilon, \dot{\Phi}_1^\epsilon) = \begin{cases} (P, P \cap F) & \text{if } p_\epsilon > 2 \\ (P \cup V, (P \cup V) \cap F) & \text{if } p_\epsilon = 2. \end{cases}$$

Note that

$$(\widehat{P}, A_\epsilon, A'_\epsilon) \cong (A_\epsilon \times I, A_\epsilon \times \{0\}, A_\epsilon \times \{1\})$$

in such a way that  $P$  is the exterior of  $a_0 \times \{\frac{1}{2}\}$  where  $a_0$  is a transverse arc of  $A_\epsilon$ .

Index the boundary components of  $A_\epsilon$  and  $A'_\epsilon$  so that  $b_i, c_i$ , and  $c'_i$  lie in the same component of  $P \cap F$ .

It is clear that  $W = V \cup P = X^\epsilon \setminus U$  is a genus 2 handlebody and  $\widehat{W} = W \cup H^\epsilon$  is a solid torus in which  $A_\epsilon \subset \partial \widehat{W}$  has winding number  $p_\epsilon$ . Then

$$(\widehat{\Sigma}_1^\epsilon, \widehat{\Phi}_1^\epsilon) = \begin{cases} (\widehat{P}, \widehat{P} \cap \widehat{F}) & \text{if } p_\epsilon > 2 \\ (\widehat{W}, \widehat{W} \cap \widehat{F}) & \text{if } p_\epsilon = 2. \end{cases}$$

In either case,  $(\widehat{P}, \widehat{P} \cap \widehat{F})$  is a regular neighbourhood of  $A_\epsilon$  in  $(\widehat{W}, \widehat{W} \cap \widehat{F})$ .

Recall the immersion  $h$  of a disk or torus  $Y$  into  $M(\alpha)$  which yields the graph  $\Gamma_F$ . Fix a face  $f$  of  $\Gamma_F$  lying in  $X^\epsilon$ . We can homotope  $h$  to a new immersion such that

- the homotopy has support in an arbitrarily small neighbourhood in  $Y$  of a compact subset of  $f$  disjoint from its corners;
- the homotopy preserves  $h^{-1}(F), h^{-1}(X^+), h^{-1}(X^-)$  and therefore  $\Gamma_F$ ;
- the restriction of the new immersion to  $f$  is transverse to  $A_\epsilon$  and further,  $f \cap h^{-1}(A_\epsilon)$  has the minimal number of components among all such immersions.

We say that  $f$  is in *minimal position* if  $h|_f$  satisfies the last of these conditions and assume that this is the case for the remainder of this subsection.

Label an endpoint of an arc component of  $h^{-1}(A_\epsilon) \cap f$  by  $i$  if its image under  $h$  lies in  $c_i$ .

**Lemma 13.5.** *Suppose that  $X^\epsilon$  is not a twisted  $I$ -bundle and that  $f$  is a minimally positioned face of  $\Gamma_F$  lying in  $X^\epsilon$ .*

- (1) *There are no closed components of  $f \cap h^{-1}(A_\epsilon)$ .*
- (2) *No arc component of  $f \cap h^{-1}(A_\epsilon)$  has both of its endpoints lying on the same edge of  $f$ .*
- (3) *If  $e$  is an edge of  $f$  and there are endpoints of arcs of  $f \cap h^{-1}(A_\epsilon)$  which are successive on  $e \cap h^{-1}(A_\epsilon)$  and have the same label, then they cobound a subarc  $e_0$  of  $e$  which is mapped by  $h$  into  $F - E \subset W$ .*

*Proof.* (1) Fix an innermost closed component  $c$  of  $f \cap h^{-1}(A_\epsilon)$  and let  $f_0 \subset f$  be the disk which it bounds. Then  $h|_{f_0}$  represents an element of  $\pi_2(U, A_\epsilon)$  or of  $\pi_2(W, A_\epsilon)$  depending on

which side of  $A_\epsilon$   $h(f_0)$  lies on. Since the homomorphisms  $\pi_1(A_\epsilon) \rightarrow \pi_1(U), \pi_1(A_\epsilon) \rightarrow \pi_1(W)$  are injective and  $\pi_2(U) \cong \pi_2(W) \cong \{0\}$ , the groups  $\pi_2(U, A_\epsilon)$  and  $\pi_2(W, A_\epsilon)$  are both  $\{0\}$ . Hence we can homotope  $h$  with support in an arbitrarily small neighbourhood of  $f_0$  to eliminate  $c$ . The minimality condition on  $h|_f$  implies that there can be no such component  $c$  of  $f \cap h^{-1}(A_\epsilon)$ . Thus  $f \cap h^{-1}(A_\epsilon)$  contains no loop components.

(2) Since  $A_\epsilon$  has winding number 2 or more in  $U$  and in  $\widehat{W}$ , the result follows as in the proof of a similar situation described in the proof of Lemma 12.4.

(3) Suppose that  $e$  is an edge of  $f$  and there are two arc components of  $f \cap h^{-1}(A_\epsilon)$  whose endpoints are successive on  $e$  and have the same label. Let  $e_0$  be the subarc of  $e$  bounded by these endpoints. Then  $h(e_0)$  is a path contained in the annulus  $E$  or  $F \setminus E$ . If  $h(e_0)$  is contained in  $E$ , it is disjoint from one of the components of  $c_1 \cup c_2 = \partial E$ . Using the fact that  $E$  strong deformation retracts onto either of its boundary components, we could homotope  $h|_f$  with support in an arbitrarily small neighbourhood of  $e_0$  to eliminate the two endpoints from  $e \cap h^{-1}(A_\epsilon)$ . Minimality shows that such a situation does not arise.  $\diamond$

We know from Lemma 13.5 that the components of  $f \cap h^{-1}(A_\epsilon)$  are arcs connecting different edges of  $f$ . Call an arc component of  $f \cap h^{-1}(A_\epsilon)$  a *corner-arc* if it is parallel to a corner of  $f$ , i.e. the arc joins adjacent edges of  $f$ . We call an arc component of  $f \cap h^{-1}(A_\epsilon)$  a *cross-arc* if it joins edges of  $f$  which are not adjacent.

Since  $A_\epsilon$  separates  $X^\epsilon$  into two components, the arcs of  $f \cap h^{-1}(A_\epsilon)$  decompose  $f$  into subsurfaces, called *tiles*, each of which is mapped by  $h$  into  $U$  or  $W$ . Adjacent tiles lie on different sides of  $A_\epsilon$ . Colour a tile red if it is mapped into  $U$  by  $h$  and call it an  $n$ -gon if its boundary contains  $n$  arcs from  $f \cap h^{-1}(A_\epsilon)$ .

**Corollary 13.6.** *Suppose that  $X^\epsilon$  is not a twisted  $I$ -bundle and that  $f$  is a minimally positioned face of  $\Gamma_F$  lying in  $X^\epsilon$ . If the intersection of a red tile with an edge  $e$  of  $f$  is non-empty, the intersection is a closed arc  $e_0$  contained in the interior of  $e$ . Further, the labels at the endpoints of  $e_0$  are different.  $\diamond$*

**Lemma 13.7.** *Suppose that  $X^\epsilon$  is not a twisted  $I$ -bundle and that  $f$  is a minimally positioned face of  $\Gamma_F$  lying in  $X^\epsilon$ .*

- (1) *If  $a$  is a corner-arc of  $f \cap h^{-1}(A_\epsilon)$ , then its endpoints have different labels.*
- (2) *No two corner-arcs in  $f \cap h^{-1}(A_\epsilon)$  are parallel in  $f$ . Equivalently, there are no red tile bigons which intersect adjacent edges of  $\partial f$ . In particular, a trigon face of  $\Gamma_F$  lying in  $X^\epsilon$  contains no red tile bigons.*

**Proof.** (1) If the endpoints of  $a$  have the same label, say 1, then  $a$  can be homotoped, with its endpoints fixed, into  $c_1 \subset F$ . So in turn, the corner of  $f$  parallel to  $a$  can be homotoped, with its endpoints fixed, into  $F$ , which is impossible.

(2) Suppose otherwise and choose  $a_1, a_2$  from among the arcs of  $f \cap h^{-1}(A_\epsilon)$  parallel to a given corner such that  $a_1 \cup a_2$  lie in the boundary of a red tile  $D$ . By part (1), the endpoints of each

$a_i$  have different labels and by Lemma 13.5(3) the labels of endpoints of  $a_1$  and  $a_2$  alternate 1, 2, 1, 2 around  $\partial D$ . This implies that the algebraic intersection in  $\partial U$  between the loop  $h|_{\partial D}$  and the circle  $c_1$  is 2. Now applying the loop theorem to the singular disk  $h|_D$  in  $U$ , we get an embedded disk  $D_*$  in  $U$  such that the geometric intersection number in  $\partial U$  between  $\partial D_*$  and  $c_1$  is either 1 or 2, which in turn implies that  $A_\epsilon$  has winding number 1 or  $2 < q_\epsilon$  in  $U$ , a contradiction. This completes the proof.  $\diamond$

**Corollary 13.8.** *Suppose that  $X^\epsilon$  is not a twisted  $I$ -bundle and that  $f$  is a minimally positioned trigon face of  $\Gamma_F$  lying in  $X^\epsilon$ . Then  $f$  contains at most one red tile and if one, it is a trigon. If there is one, then  $q_\epsilon = 3$ .*

*Proof.* Suppose that  $f$  contains a red tile. Lemma 13.7(2) shows that it cannot be a bigon, so it is a trigon. Then  $\partial D$  consists of three corner-arcs  $a_1, a_2, a_3$ , one for each corner of  $f$ , and three subarcs  $e_1^0, e_2^0, e_3^0$  of  $\partial f$ , one for each boundary edge of  $f$ . The labels of endpoints of  $a_1, a_2, a_3$  alternate 1, 2, 1, 2, 1, 2 around  $\partial D$  and so as  $h|_D : (D, \partial D) \rightarrow (U, \partial U)$ , the algebraic intersection in  $\partial U$  between the loop  $h|_{\partial D}$  and  $c_1$  is 3, which in turn by the loop theorem (as in the proof of Lemma 13.7 (2)) implies that  $q_\epsilon$ , the winding number of  $A_\epsilon$  in  $U$ , is 3.  $\diamond$

**Corollary 13.9.** *Suppose that  $X^\epsilon$  is not a twisted  $I$ -bundle and that  $f$  is a minimally positioned quad face of  $\Gamma_F$  lying in  $X^\epsilon$ . If  $e_1, e_2$  are two adjacent edges of  $f$  and two or more red tiles are incident to  $e_1$ , then there is at most one red tile incident to  $e_2$ .*

**Proof.** No red tile bigon connects adjacent edges by Lemma 13.7(2) and so as there are at least two red tiles incident to  $e_1$ , each of their boundaries contains a cross-arc. It follows that if there is a red tile incident to  $e_2$ , it must be a trigon with boundary arcs connecting  $e_1, e_2$  and the other edge  $e_3$  of  $f$  adjacent to  $e_2$ . But then any other red tile incident to  $e_2$  would have to be a bigon, which we have already ruled out.  $\diamond$

**Lemma 13.10.** *Suppose that  $X^\epsilon$  is not a twisted  $I$ -bundle and that  $f$  is a minimally positioned face of  $\Gamma_F$  lying in  $X^\epsilon$ . Let  $\{a_1, \dots, a_n\}$  be any set of parallel adjacent cross-arcs of  $f \cap h^{-1}(A_\epsilon)$ .*

- (1) *Every  $a_i$  has the same label at its endpoints or every  $a_i$  has different labels at its endpoints.*
- (2) *If the  $a_i$  have different labels at their endpoints, then  $n \leq 2$  and if 2, the two arcs are contained in different red tiles.*
- (3) *If  $e$  is an edge of  $\Gamma_F$  incident to  $f$  which has maximal weight in  $\bar{\Gamma}_F$ , the  $a_i$  connect the two edges of  $f$  adjacent to  $e$ , and the labels at the endpoints of  $a_i$  are the same, then there is a red tile incident to  $e$ .*

**Proof.** (1) Since  $A_\epsilon$  is an essential annulus in  $X^\epsilon$  and  $\pi_2(X^\epsilon, F) = 0$ , a properly embedded arc in  $A_\epsilon$  is essential as a map of pairs to  $(A_\epsilon, \partial A_\epsilon)$  if and only if it is essential as a map of pairs to  $(X^\epsilon, F)$ . It follows that for each  $i$ , the map  $h_i = h|_{a_i} : (a_i, \partial a_i) \rightarrow (X^\epsilon, F)$  is essential as a map of pairs if and only if the labels at the endpoints of  $a_i$  are distinct. Since any two of the  $h_i$  are homotopic as maps to  $(X^\epsilon, F)$ , the first assertion of the lemma follows.

(2) For the second assertion suppose  $n \geq 2$  and there is a pair of adjacent arcs  $a_i$  and  $a_{i+1}$  which lie in the boundary of some red tile  $D$ , necessarily a bigon. It follows from Lemma 13.5(3) that the labels of the endpoints of  $a_i$  and  $a_{i+1}$  alternate around  $\partial D$  as 1, 2, 1, 2, which implies that  $D$  is an essential disk in the solid torus  $U$  whose algebraic intersection number with  $c_1$  is 2. But then  $c_1$  has winding number 2 in  $U$ , a contradiction.

(3) Suppose that the  $a_i$  closest to  $e$  is  $a_1$  and that there are no red tiles incident to  $e$ . Then  $a_1$  cobounds a disk  $D$  in  $f$  with  $e$ , the two corners incident to  $e$ , and two subarcs  $e_0, e'_0$  of the edges of  $\Gamma_F$  incident to  $e$ . Since the labels at the endpoints of  $a_1$  are the same, we can homotope  $h|_{e_0 * a_1 * e'_0}$  (rel  $\partial$ ) to have image in  $F$ . But then the disk  $D$  provides an essential homotopy of  $e$  in  $X^\epsilon$  contrary to the fact that it has maximal weight. Thus there must be a red tile incident to  $e$ .  $\diamond$

#### 14. RECOGNIZING THE FIGURE EIGHT KNOT EXTERIOR

In this section we describe how work of Martelli, Petronio and Roukema can be used to recognize when  $M$  is the figure eight knot exterior. This will be used below to handle the proof of Theorem 1.2 in the case that  $d = 1$ .

**14.1. Exceptional Dehn fillings of the minimally twisted chain link.** In [MP], Martelli and Petronio classified the non-hyperbolic Dehn fillings of the “magic manifold”  $M_3$ , which is the exterior of the hyperbolic chain link of three components in  $S^3$ . (This link appears as  $6_1^3$  in Appendix C of Rolfsen’s book [Rlf].) We remark that  $M_3$  is the manifold  $N$  of the first two sections of the paper. We’ve changed notation for convenience.

The following result is contained in [MP, Corollary A.6].

**Proposition 14.1.** (Martelli, Petronio) *Let  $M$  be a hyperbolic knot manifold obtained by Dehn filling  $M_3$  along two of its boundary components. If  $M(\beta)$  is a toroidal manifold and  $M(\alpha)$  is a Seifert fibred manifold such that  $\Delta(\alpha, \beta) > 5$ , then  $M$  is the figure eight knot exterior.  $\diamond$*

In [Rou], Roukema classified all non-hyperbolic Dehn fillings on the link exterior  $M_5$  of the minimally twisted chain link of five components in  $S^3$  (shown in Figure 38).

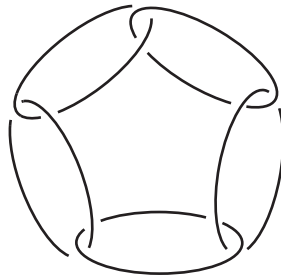

FIGURE 38.

In particular, the following result is contained in [Rou, Theorem 3 and Theorem 4].

**Proposition 14.2.** (Roukema) *Suppose that  $M$  is a hyperbolic knot manifold obtained by Dehn filling  $M_5$  along four of its boundary components but  $M$  cannot be obtained by Dehn filling  $M_3$  along two of its boundary components. Then  $\Delta(\alpha, \beta) \leq 4$  for any two non-hyperbolic filling slopes  $\alpha, \beta$  of  $M$ .  $\diamond$*

Combining the latter two propositions, one gets

**Corollary 14.3.** *Suppose that  $M$  is a hyperbolic knot manifold obtained by Dehn filling  $M_5$  along four of its boundary components. If  $M(\beta)$  is a toroidal manifold and  $M(\alpha)$  is a Seifert fibred manifold such that  $\Delta(\alpha, \beta) > 5$ , then  $M$  is the figure eight knot exterior.  $\diamond$*

**14.2. Essential annuli in  $\widehat{X}^\epsilon$  and the figure eight knot exterior.** We prove two lemmas which provide sufficient topological conditions for  $M$  to be the figure eight knot exterior.

Let  $K_\beta$  be the core of the filling solid torus in forming  $M(\beta)$ . We noted above that for each  $\epsilon$ ,  $\widehat{X}^\epsilon$  admits a Seifert structure over  $D(p_\epsilon, q_\epsilon)$ . The  $(I, S^0)$ -bundle pair  $(\Sigma_1^\epsilon, \Phi_1^\epsilon)$  extends to an  $(I, S^0)$ -bundle pair  $(\widehat{\Sigma}_1^\epsilon, \widehat{\Phi}_1^\epsilon)$  in which  $k_\epsilon = K_\beta \cap \widehat{\Sigma}_1^\epsilon$  is an  $I$ -fibre.

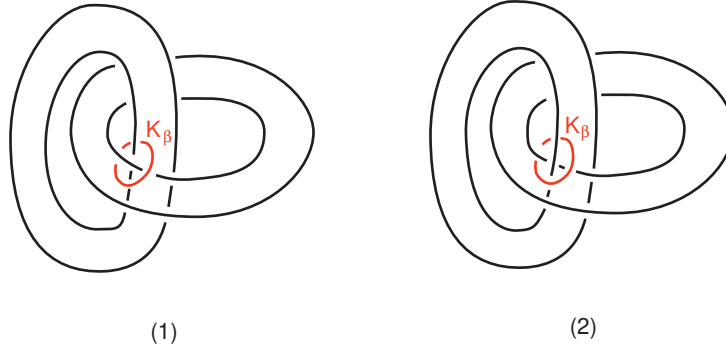

FIGURE 39.

**Lemma 14.4.** *Suppose that  $\Delta(\alpha, \beta) > 5$  and that for each  $\epsilon$  there is an embedded essential annulus  $A^\epsilon$  in  $\widehat{X}^\epsilon$  such that*

- $\partial A^\epsilon$  has slope  $\phi_\epsilon$  in  $\widehat{F}$ ;
- $k_\epsilon$  is an essential arc in  $A^\epsilon$ ;
- each boundary component of  $A^+$  intersects each boundary component of  $A^-$  transversely and exactly once.

*Then  $M$  can be obtained by Dehn filling four boundary components of the minimally twisted 5-chain link exterior and thus it is the figure eight knot exterior.*

**Proof.** Note that  $A^\epsilon$  separates  $\widehat{X}^\epsilon$  into two solid tori in which  $A^\epsilon$  has winding numbers  $p_\epsilon, q_\epsilon$  respectively and the core circles of the two solid tori are singular fibres of the Seifert fibred space  $\widehat{X}^\epsilon$ . Let  $Z^\epsilon$  be the exterior of the singular fibres in  $\widehat{X}^\epsilon$ , and let  $Z$  be the connected submanifold of  $M(\beta)$  which is the union of  $Z^+$  and  $Z^-$  in  $M(\beta)$  meeting along  $\widehat{F}$ . Then  $Z^\epsilon$  is homeomorphic



to  $Q^\epsilon \times S^1$  where  $Q^\epsilon$  is a twice punctured disk. Call  $\widehat{F}$  the outer boundary component of  $Z^\epsilon$  and called the other two boundary components of  $Z^\epsilon$  inner components. Correspondingly the component of  $\partial Q^\epsilon$  contained in  $\widehat{F}$  is called the outer component and the other two components of  $\partial Q^\epsilon$  are called inner components. The choice of  $Q^\epsilon$  in the product structure of  $Z^\epsilon = Q^\epsilon \times S^1$  is not unique. By Dehn twisting along a vertical annulus in  $Z^\epsilon$  disjoint from  $A^\epsilon$  which connects  $\widehat{F}$  to an inner boundary component of  $Z^\epsilon$ , we may assume that  $Q^+$  has been chosen so that its outer boundary component has slope  $\phi_-$  in  $\widehat{F}$  and similarly we may assume that  $Q^-$  has been chosen so that its outer boundary component has slope  $\phi_+$  in  $\widehat{F}$ . It follows that  $Z$  is homeomorphic to the exterior of “the untwisted double Hopf link” in  $S^3$  such that the torus  $\widehat{F}$  becomes a torus in  $S^3$  which bounds a trivial solid torus  $V^\epsilon$  in  $S^3$  on each side of  $\widehat{F}$  and which separates the two pairs of parallel components of the double Hopf link. Furthermore the twice punctured disk  $Q^\epsilon$  in  $Z^\epsilon$  caps off in  $V^\epsilon$  to a standard meridian disk of  $V^\epsilon$ . The annulus  $A^\epsilon$  is a vertical essential annulus in  $Z^\epsilon$  and it separates the two inner components of  $\partial Z^\epsilon$ . In fact  $A^\epsilon = \delta_\epsilon \times S^1$  where  $\delta_\epsilon$  is a proper arc in  $Q^\epsilon$  which separates the two inner components of  $\partial Q^\epsilon$ . The arc  $k_\epsilon$  in  $A^\epsilon$  is an essential arc. By Dehn twisting along a vertical annulus  $\sigma_\epsilon \times S^1$  in  $Q^\epsilon$  where  $\sigma_\epsilon$  is a proper arc in  $Q^\epsilon$  connecting the two inner boundary components of  $Q^\epsilon$  and intersecting  $\delta_\epsilon$  exactly once, we may assume that  $K_\beta = k_+ \cup k_-$  is as shown in part (1) of Figure 39 (cf. the red coloured component). Let  $Y$  be the exterior of  $K_\beta$  in  $Z$ , i.e.  $Y$  is the exterior of the 5-component link shown in Figure 39 (1). Considering Dehn surgery on the component  $K_\beta$  (the red coloured component) in  $S^3$ , we see that  $Y$  is homeomorphic to the exterior of the 5-component link in  $S^3$  shown in part (2) of Figure 39. The latter link is the minimally twisted chain link of 5 components.  $\diamond$

**Remark 14.5.** This argument was used in [GL2].

For the exterior  $N$  of a link  $L$  in  $S^3$  with components  $K_0, K_1, \dots, K_{n-1}$ , let  $T_0, T_1, \dots, T_{n-1}$  be the corresponding ordered boundary tori of  $N$ . A slope on each  $T_i$  will be expressed as  $(p, q)$  with respect to the standard (meridian, longitude) coordinates, where  $p, q$  are relative prime integers and  $q \geq 0$ , e.g.  $(1, 0)$  is the meridional slope,  $(0, 1)$  is the canonical longitude. Let  $(0, 0)$  denote the empty slope. Dehn filling of  $N$  will be denoted by  $N[(p_0, q_0), (p_1, q_1), \dots, (p_{n-1}, q_{n-1})]$ , meaning each  $T_i$  is assigned the slope  $(p_i, q_i)$ , possibly empty. For example when  $n = 3$ ,  $N[(0, 0), (-2, 1), (2, 3)]$  means leaving  $T_0$  unfilled and filling  $T_1, T_2$  with slopes  $(-2, 1), (2, 3)$  respectively. When  $N$  is clear, we may simply denote the filling by  $[(p_0, q_0), (p_1, q_1), \dots, (p_{n-1}, q_{n-1})]$ . For each  $k$ ,  $1 \leq k \leq n$ , a  $k$ -filling of  $N$  means filling  $N$  along  $k$  boundary tori with nonempty slopes and leaving the rest of the boundary tori unfilled. For example  $N[(0, 0), (-2, 1), (2, 3)]$  is a 2-filling of  $N$ .

**Lemma 14.6.** *Suppose that  $\Delta(\alpha, \beta) > 5$ ,  $X^-$  is a twisted  $I$ -bundle and  $d = 1$ . Suppose that for each  $\epsilon$  there is an embedded essential annulus  $A^\epsilon$  in  $\widehat{X}^\epsilon$  such that*

- $\partial A^+$  has slope  $\phi_+$  in  $\widehat{F}$  and  $\partial A^-$  has slope  $\phi'_-$  in  $\widehat{F}$ ;
- $k_\epsilon$  is an essential arc in  $A^\epsilon$ ;
- each boundary component of  $A^+$  intersects each boundary component of  $A^-$  transversely and exactly once.

Then  $M$  can be obtained by Dehn filling the boundary components  $T_1, \dots, T_6$  of the exterior of the 7-component link  $\{K_0, K_1, \dots, K_6\}$  in  $S^3$  shown in Figure 41(2) such that the slopes on  $T_3$  and  $T_4$  are both  $(-1, 1)$ . Furthermore  $M$  is the figure eight knot exterior.

*Proof.* As in the proof of Lemma 14.4, let  $Z^\epsilon$  be the exterior of the singular fibres in  $\widehat{X}^\epsilon$  with respect to the Seifert structure whose base orbifold is  $D^2(p_\epsilon, q_\epsilon)$ , and let  $Z$  be the connected submanifold of  $M(\beta)$  which is the union of  $Z^+$  and  $Z^-$  in  $M(\beta)$  meeting along  $\widehat{F}$ . Then  $Z^\epsilon$  is homeomorphic to  $Q^\epsilon \times S^1$  where  $Q^\epsilon$  is a twice punctured disk. Since  $d = 1$ , we have, as in the proof of Lemma 14.4, that  $Z$  is homeomorphic to the exterior of “the double Hopf link” in  $S^3$  such that the torus  $\widehat{F}$  becomes a torus in  $S^3$  which bounds a trivial solid torus  $V^\epsilon$  in  $S^3$  on each side of  $\widehat{F}$  and which separates the two pairs of parallel components of the double Hopf link and that the twice punctured disk  $Q^\epsilon$  in  $Z^\epsilon$  caps off in  $V^\epsilon$  to a standard meridian disk of  $V^\epsilon$ . Figure 40 shows  $Z^-$  cut open along  $Q^-$ . Note that  $\widehat{X}^-$  is an annulus bundle over  $S^1$  with  $A^-$  as a fibre. The part of  $A^-$  in  $Z^-$  is a twice punctured annulus. Figure 40 shows the part of  $A^-$  in the cut-open  $Z^-$  (the surface coloured green). Here we may assume that  $A^-$  is of the form shown in Figure 40 inside  $Z = Z^+ \cup Z^-$  (i.e. after the specific choice of  $Q^-$  for  $Z^-$ ) since there is only one twisted I-bundle over the Klein bottle up to homeomorphism.

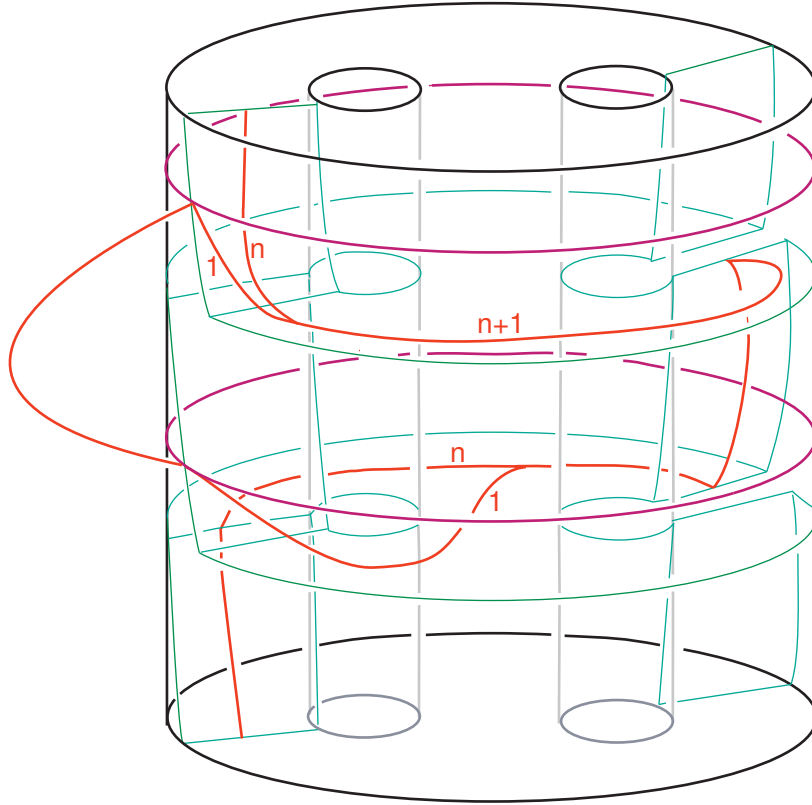

FIGURE 40.

Also as in the proof of Lemma 14.4, we have that the annulus  $A^+$  separates the two inner components of  $\partial Z^+$ ,  $\partial A^+$  is as shown in Figure 40 (the two horizontal circles coloured purple), and up to Dehn twists and isotopy, the arc  $k_+$  in  $A^+$  is transverse to the  $S^1$  fibres of  $A^+$  and is

disjoint from a copy of  $Q^+$  (shown in Figure 40 as the red coloured arc that lies outside  $Z^-$ ). The arc  $k_-$  is an essential transverse arc in  $A^-$  which may wrap along the  $S^1$  factor of  $A^-$  many times. In Figure 40  $k_-$  is illustrated as a branched curve in  $A^-$  (a branch with label  $n$  means  $n$  parallel arcs in  $A^-$ ). To eliminate the wraps of  $k_-$  in  $A^-$ , we drill out two knots  $K_5, K_6$  in  $Z^-$  which are chosen as follows:  $\partial A^-$  cuts the torus  $\widehat{F}$  into two annuli, push the center circle of each of these two annuli slightly into the interior of  $Z^-$  but disjoint from  $A^-$ , the resulting knots are  $K_5$  and  $K_6$ . Let  $Y^-$  be the exterior of  $K_5$  and  $K_6$  in  $Z^-$ , and let  $T_5$  and  $T_6$  be the torus boundary components of  $Y^-$  corresponding to  $K_5$  and  $K_6$ . There is an obvious essential annulus  $A$  in  $Y^-$  connecting  $T_5$  and  $T_6$  which intersects  $A^-$  in a single circle which is essential in both  $A$  and  $A^-$ . Twisting along this annulus  $A$  (which does not change the homeomorphism type of  $Y^-$ , which fixes  $\widehat{F}$  point-wise and which preserves  $A^-$  set-wise) together with some isotopy, we may simplify  $k_-$  in  $A^-$  so that it does not fully wrap around the  $S^1$  factor of  $A^-$  and is disjoint from a copy of  $Q^-$ . Now let  $N$  be the exterior in  $S^3$  of the 7-component link shown in part (1) of Figure 41 where the red coloured component  $K_0$  is  $K_\beta = k_+ \cup k_-$ , the two green coloured components are  $K_5$  and  $K_6$  and the remaining four components form the double Hopf link. Then by the construction of  $N$ ,  $M$  can be obtained by Dehn filling the six boundary components  $T_1, \dots, T_6$  of  $N$ , leaving  $T_0$  unfilled.

Note that the twisted  $I$ -bundle over the Klein bottle  $\widehat{X}^-$  can be recovered from  $Z^-$  by Dehn filling the two inner boundary tori  $T_3$  and  $T_4$  of  $Z^-$  both with slope  $(-2, 1)$  since the twisting along the annulus  $A$  above fixes  $T_3$  and  $T_4$  point-wise and thus does not change filling slopes on these two tori.

Simplifying this link as illustrated in Figure 41 (which does not change the homeomorphism type of  $N$ ), we get the link shown in Figure 41 part (2). By the Kirby-Rolfsen surgery calculus, the filling slope for the new  $T_3$  and  $T_4$  becomes  $(-1, 1)$ . This proves the first conclusion of the lemma.

To prove the second conclusion of the lemma, let  $N$  be the exterior of the ordered 7-component link in  $S^3$  shown in part (2) of Figure 41, which can be checked with SnapPy to be hyperbolic. Our manifold  $M$  is supposed to be a hyperbolic filling of  $N$  leaving  $T_0$  unfilled, i.e.

$$M = N[(0, 0), (p_1, q_1), (p_2, q_2), (-1, 1), (-1, 1), (p_5, q_5), (p_6, q_6)]$$

for some nonempty slopes  $(p_1, q_1), (p_2, q_2), (p_5, q_5), (p_6, q_6)$ . Let  $Y$  be the manifold

$$N[(0, 0), (0, 0), (0, 0), (-1, 1), (-1, 1), (0, 0), (0, 0)].$$

There is an annulus  $E$  in  $Y$  joining  $T_5$  and  $T_6$  (since  $\widehat{X}^-$  is an  $A^-$ -bundle over  $S^1$ ,  $K_5$  and  $K_6$  bound an annulus in  $\widehat{X}^-$  disjoint from the annulus  $A^-$  which contains  $k_-$ ). A regular neighbourhood  $Z_*$  of  $E \cup T_5 \cup T_6$  in  $Y$  is homeomorphic to  $P \times S^1$ , where  $P$  is a twice punctured disk. Let  $W = Y \setminus Z_*$ , and let  $T$  be the torus  $W \cap Z_*$ . Our manifold  $M$  is obtained by Dehn filling  $Y$  along  $T_1, T_2, T_5$  and  $T_6$ :  $M = \widehat{W} \cup_T \widehat{Z}_*$ , say, where  $\widehat{W}$  is the result of Dehn filling  $W$  along  $T_1$  and  $T_2$  with slopes  $(p_1, q_1)$  and  $(p_2, q_2)$ , and  $\widehat{Z}_*$  is  $Z_*$  Dehn filled along  $T_5$  and  $T_6$  with slopes  $(p_5, q_5)$  and  $(p_6, q_6)$ . Since  $M$  is hyperbolic,  $T$  compresses in either  $\widehat{Z}_*$  or  $\widehat{W}$ . In the first case,  $\widehat{Z}_*$  must be a solid torus, and in the second case,  $\widehat{W} \cong M \# V$ , where  $V$  is a solid torus and  $V \cup \widehat{Z}_* \cong S^3$ . In the first case,  $\widehat{Z}_*$  can be obtained from  $Z_*$  by doing the

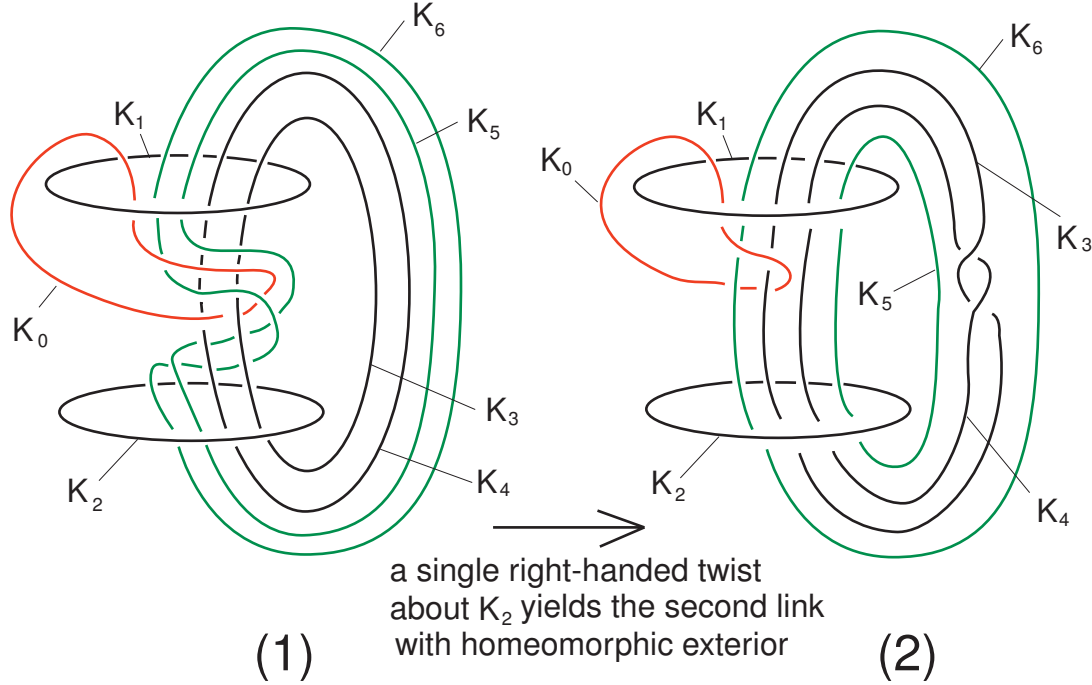

FIGURE 41.

trivial Dehn filling  $(1, 0)$  on  $T_6$  and some filling on  $T_5$ , with slope  $(p'_5, q'_5)$ , say. In the second case, we can do a similar Dehn filling on  $Z_*$  to get a solid torus  $U$  such that  $V \cup_T U \cong S^3$ . Thus in both cases  $M = N[(0, 0), (p_1, q_1), (p_2, q_2), (-1, 1), (-1, 1), (p'_5, q'_5), (1, 0)]$ . That is, if  $N_*$  is the exterior of the 6-component link in  $S^3$  shown in part (1) of Figure 42, then  $M = N_*[(0, 0), (p_1, q_1), (p_2, q_2), (-1, 1), (-1, 1), (p'_5, q'_5)]$ . Using the Kirby-Rolfsen surgery calculus we can eliminate the component  $K_4$  and get the ordered 5-component link  $\{J_0, J_1, J_2, J_3, J_4\}$  in  $S^3$  shown in part (2) of Figure 42 so that  $M = N_\#[(0, 0), (m_1, n_1), (m_2, n_2), (m_3, n_3), (0, 1)]$  for non-empty slopes  $(m_1, n_1), (m_2, n_2), (m_3, n_3)$ , where  $N_\#$  is the exterior of the ordered 5-component link  $\{J_0, J_1, J_2, J_3, J_4\}$  in  $S^3$ .

The five component link  $\{J_0, J_1, J_2, J_3, J_4\}$  in  $S^3$  is hyperbolic and we have reduced the proof of the lemma to the proof of the following

**Claim.** If  $M$  can be obtained by Dehn filling  $N_\#$  along  $T_1, \dots, T_4$  with slope  $(0, 1)$  on  $T_4$ , then  $M$  is the figure 8 knot exterior.

It is enough to show that if a 4-filling  $N_\#[(0, 0), (m_1, n_1), (m_2, n_2), (m_3, n_3), (0, 1)]$  is a hyperbolic manifold which has two non-hyperbolic filling slopes on  $T_0$  distance at least 6 apart, then it is either the figure eight knot exterior, or  $Wh[(0, 0), (-2, 1)]$  or  $Wh[(0, 0), (5, 1)]$ , where  $Wh$  is the exterior of the Whitehead link in the 3-sphere<sup>1</sup>, because for each of  $Wh[(0, 0), (-2, 1)]$  and

<sup>1</sup>For the rest of this section we've replaced the Whitehead link exterior  $Wh$  (cf. Figure 1) with its mirror image as a matter of convenience.

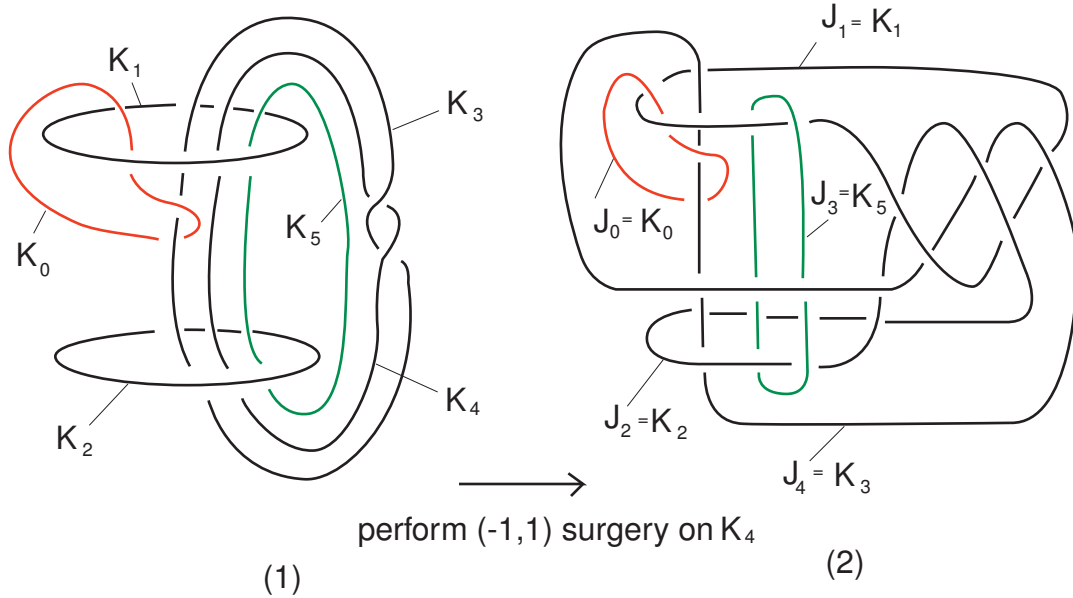

FIGURE 42.

$Wh[(0, 0), (5, 1)]$ , if two non-hyperbolic filling slopes are distance at least 6 apart, they are both toroidal filling slopes.

To this end, we apply the Python codes *find\_exceptional\_fillings.py* and *search\_geometric\_solutions* written by Martelli [Ma], used on SnapPy written by Culler, Dunfield, Goerner and Weeks [CDGW], to the 5-component link exterior  $N_{\#}$ . Note that when running *find\_exceptional\_fillings.py* on the 5-component link exterior  $N_{\#}$  we only need to find those fillings of  $N_{\#}$  which either have slope  $(0, 1)$  on  $T_4$  or leave  $T_4$  unfilled (this can be done by adding a finite set of well chosen 1-fillings into the *exclude.py* file in Martelli's Python package). We get two lists as the outputs from running the code *find\_exceptional\_fillings.py*: a list of candidate isolated non-hyperbolic fillings on  $N_{\#}$  and a list of candidate hyperbolic fillings on  $N_{\#}$ , here an isolated non-hyperbolic filling means a non-hyperbolic filling whose proper sub-fillings are all hyperbolic fillings.

We first need to check if the fillings in the second list are indeed hyperbolic fillings, which is accomplished by running *search\_geometric\_solutions* on it. It turns out the fillings in the second list are all 5-fillings (there are 862 of them) and they are all hyperbolic. (To reduce the running time, we first set the max degree in the code to 3, at which 809 fillings are confirmed to be hyperbolic, then set the max degree at 5, at which another twenty fillings are confirmed, then degree 7 confirming twenty-six more fillings. The remaining seven fillings are confirmed at degree 11.)

We now deal with the first list. We don't have to confirm if all the fillings listed are indeed non-hyperbolic. We treat them as possible isolated non-hyperbolic fillings. The good thing is that

the list contains all real isolated non-hyperbolic fillings. The list contains eight 1-fillings, twenty-seven 2-fillings, sixty-three 3-fillings, one hundred and seventy 4-fillings and three hundred and one 5-fillings.

If a  $k$ -filling of  $N_\#$ ,  $1 \leq k \leq 3$ , is an isolated non-hyperbolic filling but contains hyperbolic pieces, it might extend to infinitely many hyperbolic 4-fillings of  $N_\#$  with  $T_0$  unfilled, which could potentially contribute many new non-hyperbolic slopes on  $T_0$  which have not occurred in the fillings of the list. Therefore such cases, if they exist, are potentially difficult to deal with. Fortunately such a case does not happen for our manifold  $N_\#$ . There are some  $k$ -fillings,  $1 \leq k \leq 3$ , which are isolated non-hyperbolic containing hyperbolic pieces. But after adding the slope  $(0, 1)$  on  $T_4$  to such  $k$ -filling (if  $T_4$  is unfilled there), it still contains a hyperbolic piece only when its slope on  $T_0$  is non-empty and therefore this  $k$ -filling contributes at most one non-hyperbolic slope on  $T_0$ . Similarly we don't need to worry about isolated non-hyperbolic 4-fillings as each of them either contributes only one slope on  $T_0$  or can not yield  $M$ .

Now we combine fillings in the first list (exclude those with empty slope on  $T_0$ ) into the list of maximal subgroups so that in each subgroup any two fillings are compatible in the sense that their slopes on each of  $T_1, T_2, T_3, T_4$  agree unless one or both of them are empty. (The new list, obtained using a simple Python code, as well as the two lists mentioned earlier will be posted along with the paper on authors' web pages). Each such subgroup contains at least one 5-filling which by restriction gives a hyperbolic 4-filling leave  $T_0$  unfilled (this hyperbolic 4-filling is unique for this subgroup). Slopes on  $T_0$  from the elements in this subgroup contain all possible non-hyperbolic filling slopes for the hyperbolic 4-filling. So we just need to calculate the distance between such slopes on  $T_0$  for each subgroup (which can be done using a simple Python code). It turns out that if the distance between two slopes on  $T_0$  from a subgroup is at least 6, then one of the following events holds:

- 1) The corresponding hyperbolic 4-filling for this subgroup is the figure eight knot exterior (occurs for 4 subgroups) or  $Wh[(0, 0), (5, 1)]$  (occurs for 4 subgroups) or  $Wh[(0, 0), (-2, 1)]$  (occurs for 8 subgroups), which can be verified by SnapPy.
- 2) One of the two slopes is  $(0, 1)$ . But this slope is not a non-hyperbolic slope of the corresponding 4-filling of the subgroup, which can be checked using *search\_geometric\_solutions*. (Such instance occurs for 11 subgroups). Such case happens because  $[(1, 0), (0, 0), (0, 0), (0, 0), (0, 0)]$  is a non-hyperbolic filling which contains a hyperbolic piece.
- 3) The distance is 7 and is realized on the unique pair  $[(-3, 4), (2, 1), (3, 1), (-2, 1), (0, 1)]$  and  $[(1, 1), (2, 1), (0, 0), (0, 0), (0, 0)]$ . But  $[(1, 1), (2, 1), (3, 1), (-2, 1), (0, 1)]$  is hyperbolic. This happens because  $[(1, 1), (2, 1), (0, 0), (0, 0), (0, 0)]$  is an isolated non-hyperbolic filling which contains hyperbolic piece.

The proof of the second conclusion of the lemma is now finished.  $\diamond$

**14.3. The combinatorics of  $\bar{\Gamma}_F$  and the figure eight knot exterior.** We show how combinatorial conditions on  $\bar{\Gamma}_F$  guarantee the existence of annuli as in the previous subsection.

**Proposition 14.7.** *Suppose that  $d \neq 0$ ,  $\Delta(\alpha, \beta) \geq 6$ , and  $f$  is a trigon face of  $\bar{\Gamma}_F$  contained in  $X^\epsilon$  with a maximal weight edge  $\bar{e}$ . Then there are annuli  $A^+$  and  $A^-$  with the properties given in Lemma 14.4. Therefore  $M$  is the figure eight knot exterior.*

*Proof.* Since  $f$  is a trigon,  $X^\epsilon$  is not a twisted  $I$ -bundle and by Lemma 13.3,  $\bar{e}$  is a positive edge.

Let  $e_1, e_2, e_3$  be parallel adjacent edges of  $\Gamma_F$  corresponding to  $\bar{e}$  where  $e_1$  is an edge of  $f$  and  $e_2$  is the edge lying between  $e_1$  and  $e_3$ . Since  $\bar{e}$  is a positive edge of weight 3 or more,  $\widehat{\Sigma}_1^+$  is a twisted  $I$ -bundle over a Möbius band and  $\widehat{\Sigma}_1^-$  is either a twisted  $I$ -bundle over a Möbius band or a twisted  $I$ -bundle over a Klein bottle.

After a homotopy of  $h$  we can assume that the face  $f$  of  $\Gamma_F$  is minimally positioned (cf. §13.3). Recall that  $A_\epsilon$  is the frontier of  $\widehat{\Sigma}_1^\epsilon$  in  $\widehat{X}^\epsilon$  with boundary components  $c_1$  and  $c_2$ ,  $\widehat{P} = A_\epsilon \times I$  is a product region in  $\widehat{\Sigma}_1^\epsilon$  and  $k_\epsilon = K_\beta \cap H^\epsilon$  is an essential arc in  $A^\epsilon = A_\epsilon \times \{1/2\}$ . By Corollary 13.8,  $e_1$  can be homotoped in  $F$  with its two endpoints fixed so that it intersects each  $c_i$  at most once. Further, since the bigon face between  $e_2$  and  $e_3$  lies in  $X^\epsilon$ ,  $e_2$  can be homotoped in  $F$  with its two endpoints fixed so that it is contained in the interior of  $\widehat{\Phi}_1^\epsilon$ .

Recall that  $\partial X^{-\epsilon} = F \cup B^{-\epsilon}$  and  $b_1, b_2$  are components of  $\partial F = \partial B^{-\epsilon}$ .

If we apply the loop theorem to the algebraic bigon  $R$  between  $e_1$  and  $e_2$  with respect to the algebraic intersection with  $b_1$ , we obtain an embedded disk  $D$  in  $X^{-\epsilon}$  such that  $\partial D$  has non-zero algebraic intersection with  $b_1$ . In particular  $\partial D$  must intersect  $b_1$ . The loop theorem implies that we may assume that  $\partial D \cap (B^{-\epsilon} \cup c_1 \cup c_2)$  is contained in  $h(\partial R) \cap (B^{-\epsilon} \cup c_1 \cup c_2)$  (cf. [He, Theorem 4.10]). Lemma 11.1(1) shows that  $D$  cannot be a monogon, so it is an algebraic bigon. Each of the two components of  $F \cap \partial D$  are arcs connecting  $b_1$  and  $b_2$  so that one of them,  $d_1$  say, intersects each  $c_i$  at most once, and the other,  $d_2$  say, is contained in the interior of  $\widehat{\Phi}_1^\epsilon$ , and thus is disjoint from each  $c_i$ .

Note that  $D$  is part of an embedded Möbius band in  $X^{-\epsilon}$  obtained by attaching a product region in the annulus  $B^{-\epsilon}$  between the two corners of  $D$  (cf. the proof of Lemma 12.5). The boundary of this Möbius band has slope  $\phi_{-\epsilon}$  and  $c_i$  has slope  $\phi_\epsilon$ . Our hypothesis that  $d \neq 0$  implies that  $\phi_+ \neq \phi_-$ , so the boundary of the Möbius band intersects each  $c_i$  exactly once and the intersection is transverse. (So  $d = 1$ .) That is, the edge  $d_1$  intersects each  $c_i$  transversely exactly once.

Recall  $\hat{b}_1$  and  $\hat{b}_2$  are the disks attached to  $F$  to form  $\widehat{F}$ . If we consider  $\hat{b}_1, \hat{b}_2$  as points then  $d_1 \cup \hat{b}_1 \cup d_2 \cup \hat{b}_2$  is a loop in  $\widehat{F}$  of slope  $\phi_{-\epsilon}$  which intersects  $c_i$  transversely exactly once. We may now isotope  $D$  in  $X^{-\epsilon}$  so that its edges become transverse to the  $S^1$ -fibres of the annulus  $\widehat{\Phi}_1^\epsilon$ . Figures 43(1) and (2) illustrate the possibilities for the edges  $d_1$  and  $d_2$  of  $D$  up to Dehn twists fixing their endpoints along a  $S^1$ -fibre of the annulus  $\widehat{\Phi}_1^\epsilon$ . If the case of Figure 43(1) occurs, the resulting algebraic bigon  $D$  yields a corresponding embedded Möbius band  $B$  in  $X^{-\epsilon}$  such that the frontier of a suitably chosen regular neighbourhood of  $B$  in  $\widehat{X}^{-\epsilon}$  is an essential annulus

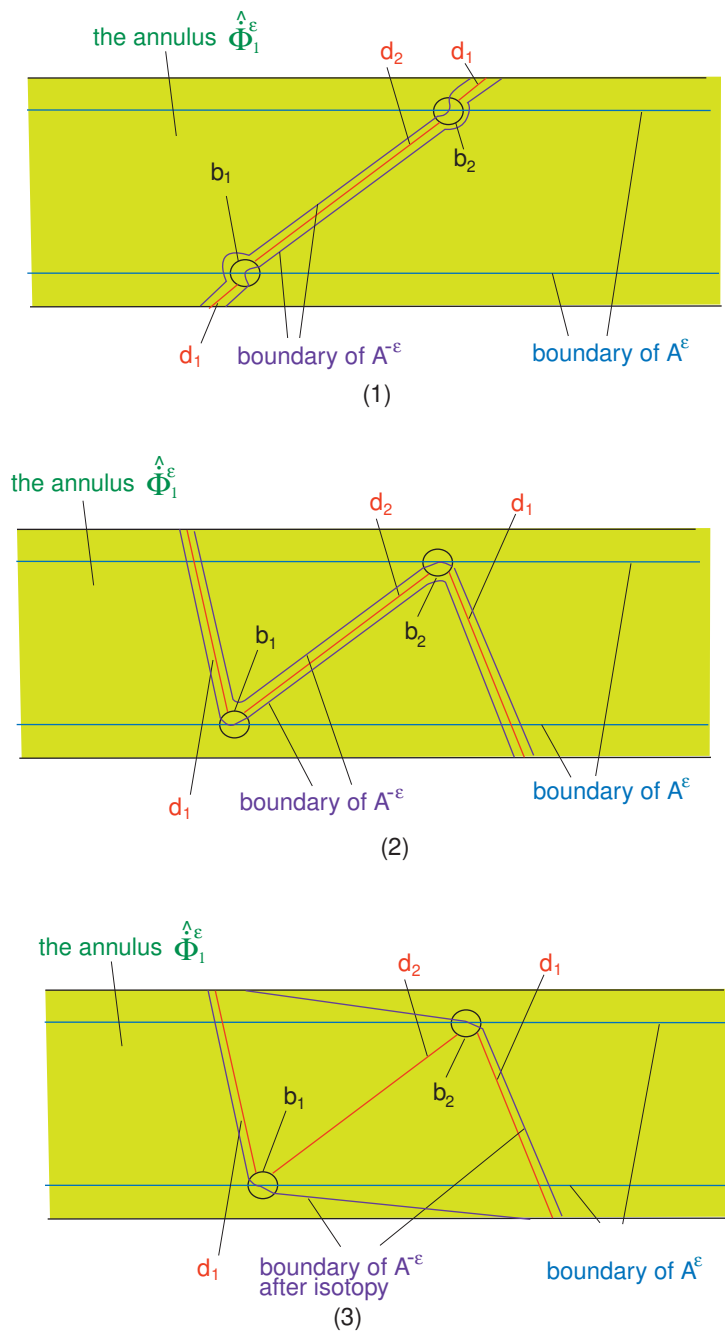

FIGURE 43.

$A^{-\epsilon}$  which contains  $k_{-\epsilon}$  as an essential arc. Moreover each component of  $\partial A^{-\epsilon}$  intersects each component of  $\partial A^{\epsilon}$  exactly once. The boundary of  $A^{-\epsilon}$  is illustrated in Figure 43(1).

If the case of Figure 43(2) occurs, the resulting algebraic bigon  $D$  also yields a corresponding embedded Möbius band  $B$  in  $X^{-\epsilon}$  such that the frontier of a suitably chosen regular neighbourhood of  $B$  in  $\hat{X}^{-\epsilon}$  is an essential annulus  $A^{-\epsilon}$  which contains  $k_{-\epsilon}$  as an essential arc, as



illustrated in Figure 43(2). But at this stage each component of  $\partial A^{-\epsilon}$  intersects each component of  $\partial A^\epsilon$  exactly twice, one transverse and one tangent. We may now isotope  $A^{-\epsilon}$  in  $\widehat{X^{-\epsilon}}$ , fixing the arc  $k_{-\epsilon} \subset A^{-\epsilon}$ , so that at the end of the isotopy each component of  $\partial A^{-\epsilon}$  intersects each component of  $\partial A^\epsilon$  exactly once, and transversely, as indicated in Figure 43(3).  $\diamond$

**Proposition 14.8.** *If  $\Delta(\alpha, \beta) \geq 6$  and there is a quad face  $f$  of  $\bar{\Gamma}_F$  with adjacent edges of maximal weight, then there are annuli  $A^+$  and  $A^-$  with the properties given in Lemma 14.4. Therefore  $M$  is the figure eight knot exterior.*

**Proof.** Suppose that  $f$  lies in  $X^\epsilon$  and note that  $X^\epsilon$  cannot be a twisted  $I$ -bundle as in this case the only faces of  $\Gamma_F$  lying in  $X^-$  are bigons. We may assume that  $f$  is minimally positioned (cf. §13.3).

By Corollary 13.9,  $f$  has an edge  $\bar{e}$  of maximal weight which intersects each  $c_i$  at most once. Let  $e_1, e_2, e_3$  be the parallel adjacent edges in the family of edges represented by  $\bar{e}$  with  $e_1$  being the edge of  $f$  and  $e_2$  being the one between  $e_1$  and  $e_3$ . Note that we may assume that  $e_2$  is contained in the interior of  $\dot{\Phi}_1^\epsilon$  and thus is disjoint from each  $c_i$ .

Let  $R$  be the bigon face between  $e_1$  and  $e_2$ . Note that  $\partial R$  is an essential loop in  $\partial X^{-\epsilon}$  since each of the edges  $e_1$  and  $e_2$  is an essential arc in  $F$ , so we can apply the loop theorem to the singular disk  $R$  which is the bigon face between  $e_1$  and  $e_2$ . We obtain a properly embedded disk  $(D, \partial D)$  in  $(X^{-\epsilon}, \partial X^{-\epsilon})$  such that  $\partial D$  is an essential loop in  $\partial X^{-\epsilon}$  which intersects each  $c_i$  transversely and in at most one point. Since  $F$  is incompressible and  $X^{-\epsilon}$  does not contain a monogon,  $D$  is a bigon.

If  $D$  is an algebraic 0-gon, its edges are disjoint  $\widehat{F}$ -essential loops and therefore their algebraic intersection with each  $c_i$  is even, contrary to what we have deduced. Thus it is an algebraic bigon. Now proceed as in the proof of Proposition 14.7 to see that the existence of such an embedded disk  $D$  implies that there are annuli  $A^+$  and  $A^-$  with the properties given in Lemma 14.4. Therefore  $M$  is the figure eight knot exterior.  $\diamond$

**Proposition 14.9.** *Suppose that  $\Delta(\alpha, \beta) = 6$  and  $d = 1$ . If  $\bar{\Gamma}_F$  has two trigon faces  $f_1$  and  $f_2$  sharing a common positive edge  $\bar{e}$  of weight 2, then  $M$  is the figure eight knot exterior.*

**Proof.** Let  $e_1$  and  $e_2$  be the two parallel edges of  $\Gamma_F$  represented by  $\bar{e}$ . Note that  $f_1$  and  $f_2$  lie on the same side of  $F$ , say  $X^\epsilon$ , and as they are trigons,  $X^\epsilon$  is not a twisted  $I$ -bundle. We may assume that each of  $e_1$  and  $e_2$  intersects each  $c_i$  exactly once by Corollaries 13.6(2) and 13.8.

The bigon  $R$  containing  $e_1$  and  $e_2$  in its boundary is an  $S$ -bigon. That is,  $e_1$  and  $e_2$  form an  $S$ -cycle. Applying the loop theorem to the singular disk  $R$  with respect to (mod 2) intersection with  $b_1$  yields an embedded  $S$ -bigon  $D$  in  $X^{-\epsilon}$  the union of whose two edges intersects each  $c_i$  at most twice. As in the proof of Proposition 14.7, the bigon yields a Möbius band in  $X^{-\epsilon}$  whose boundary has slope  $\phi_{-\epsilon}$  and intersects each  $c_i$  at most twice. Since  $d = 1$ , we see that the boundary of the Möbius band intersects each  $c_i$  exactly once and the intersection is transverse. As in the proof of Proposition 14.7, such a Möbius band will yield an embedded

essential annulus  $A^{-\epsilon}$  which together with  $A^\epsilon$ , chosen as in the proof of Proposition 14.7, satisfy the properties of Lemma 14.4 and thus  $M$  is the figure eight knot exterior.  $\diamond$

**Proposition 14.10.** *Suppose that  $\Delta(\alpha, \beta) = 6$ ,  $d = 1$  and  $X^-$  is a twisted  $I$ -bundle. If  $\bar{\Gamma}_F$  has two trigon faces  $f_1$  and  $f_2$  sharing a common edge  $\bar{e}$ , then  $M$  is the figure eight knot exterior.*

**Proof.** Since  $X^-$  is a twisted  $I$ -bundle, both  $f_1$  and  $f_2$  lie in  $X^+$ . By Proposition 14.7, we may assume that  $\bar{e}$  has weight 2.

Let  $e_1$  and  $e_2$  be the two parallel edges of  $\Gamma_F$  represented by  $\bar{e}$ . By Corollary 13.8, we may assume that each of  $e_1$  and  $e_2$  intersects each  $c_i$  at most once. Now applying the loop theorem to the bigon face  $R$  of  $\Gamma_F$  containing  $e_1$  and  $e_2$  in its boundary to obtain an embedded bigon  $D$  in  $X^-$ . The boundary of  $D$  intersects each  $c_i$  transversely and in at most two points.

**Case 1.**  $D$  is an algebraic 0-gon.

In this case, the edges of  $D$  are disjoint  $\widehat{F}$ -essential loops and therefore their union intersects each  $c_i$  transversely in at most two points. Since these two loops are homologous, either both are disjoint from the  $c_i$  or both intersect each  $c_i$  exactly once.

As in the third paragraph of the proof of Lemma 12.6, the edges of  $D$  form a pair of  $\widehat{F}$ -essential loops which are the boundary of an essential annulus  $A^-$  in  $X^-$ . Thus they have slope  $\phi_-$  or  $\phi'_-$ . Since  $d = 1$  and  $d' \neq 0$  (cf. Proposition 13.2), each edge of  $D$ , which is an  $\widehat{F}$ -essential loop in  $F$ , intersects each  $c_i$  exactly once and the intersection is transverse. In particular, in the case that the edges of  $D$  have slope  $\phi'_-$ , we have  $d' = 1$ . The reader will verify that  $A^-$  and  $A^+$  can be positioned to have the properties listed in the statement of Lemma 14.4 when  $\partial A^-$  has slope  $\phi_-$ , or those listed in Lemma 14.6 when  $\partial A^-$  has slope  $\phi'_-$ . Hence  $M$  is the figure eight knot exterior.

**Case 2.**  $D$  is an algebraic bigon.

The argument is similar to that given in the proof of Proposition 14.7.  $\diamond$

The proof of Proposition 14.10 actually shows the following result.

**Corollary 14.11.** *Suppose that  $\Delta(\alpha, \beta) = 6$ ,  $d = 1$ , and  $X^-$  is a twisted  $I$ -bundle. If  $\Gamma_F$  has a bigon face in  $X^-$  the union of whose two edges are incident to at most two red tiles, then  $M$  is the figure eight knot exterior.  $\diamond$*

**Proposition 14.12.** *If  $\Delta(\alpha, \beta) = 6$ ,  $d = 1$ ,  $X^-$  is a twisted  $I$ -bundle, and there is a 5-gon face  $f$  of  $\bar{\Gamma}_F$  with adjacent edges of weight 4, then  $M$  is the figure eight knot exterior.*

**Proof.** Note that  $f$  lies in  $X^+$ , so we may assume that  $f$  is minimally positioned (cf. §13.3). Let  $e_1$  and  $e_2$  be adjacent edges of  $f$  in  $\Gamma_F$  which have maximal weight. Suppose that we can show that there are at most two red tiles incident to one of these edges,  $e_1$  say. Since  $q_+ \geq 3$ , no bigon face of  $\Gamma_F$  lying in  $X^+$  contains a red tile, so we can apply Corollary 14.11 to the bigon face of  $\Gamma_F$  incident to  $e_1$  to complete the proof.

Suppose that there are three red tiles incident to each of  $e_1$  and  $e_2$ . Since  $q_+ \geq 3$ , there are no red tile bigons connecting  $e_1$  to either of its adjacent edges in  $\partial f$ , and a similar statement holds for  $e_2$ . It follows that for  $i = 1, 2$ , a red tile incident to  $e_i$  contains a cross-arc in its boundary running between  $e_i$  and the edge  $e'$  of  $f$  which is adjacent to neither  $e_1$  nor  $e_2$  (cf. Figure 44). By Lemma 13.10, each cross-arc connecting  $e_1$  and  $e'$  has the same labels at its endpoints, and the same holds for the cross-arcs connecting  $e_2$  and  $e'$ . But then the restriction of  $h$  to each of these arcs is homotopic (rel endpoints) to a path in  $F$  and so we can construct a monogon in  $X^+$  (cf. Figure 44); the sub-disk of  $f$  between the cross-arcs  $a$  and  $a'$  with a corner at  $v$  is a monogon), which gives a contradiction.  $\diamond$

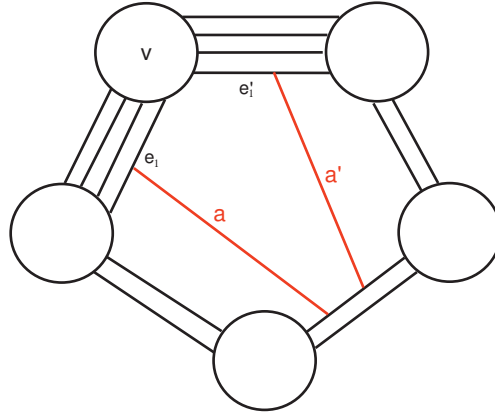

FIGURE 44.

#### 15. COMPLETION OF THE PROOF OF THEOREM 1.2 WHEN $\Delta(\alpha, \beta) \geq 7$

To complete of the proof of Theorem 1.2 when  $\Delta(\alpha, \beta) \geq 7$ , we must prove the following proposition.

**Proposition 15.1.** *Suppose that Assumptions 4.3 and 9.2 hold,  $F$  is separating but not a semi-fibre, and  $t_1^+ = t_1^- = 0$ . If  $\Delta(\alpha, \beta) \geq 7$ , then  $M$  is the figure eight knot exterior.*

**Proof.** Since the edges of  $\bar{\Gamma}_F$  have weight at most 4 (Lemma 13.3), for each vertex  $v$  of  $\Gamma_F$  we have an inequality

$$14 \leq 2\Delta(\alpha, \beta) = \text{valency}_{\Gamma_F}(v) \leq 4 \text{ valency}_{\bar{\Gamma}_F}(v),$$

which shows that the valency of  $v$  in  $\bar{\Gamma}_F$  is at least 4.

First suppose that there is a vertex  $v$  of  $\Gamma_F$  such that  $\mu(v) > 2\Delta(\alpha, \beta) - 4$ . Proposition 12.2 of [BGZ2] then shows that the valency of  $v$  is at most 5 and

$$\varphi_3(v) \geq \begin{cases} 1 & \text{if valency}(v) = 4 \\ 4 & \text{if valency}(v) = 5 \end{cases}$$

Consequently, the condition that  $\Delta(\alpha, \beta) \geq 7$  implies that there is a trigon face of  $\bar{\Gamma}_F$  incident to  $v$  with an edge of maximal weight and therefore  $M$  is the figure eight knot exterior by Proposition 14.7.

Thus we may assume that  $\mu(v) \leq 2\Delta(\alpha, \beta) - 4$  for each  $v$ . By Corollary 12.4 of [BGZ2],  $\mu(v) = 2\Delta(\alpha, \beta) - 4$  for each  $v$  and then Proposition 12.5 of [BGZ2] implies that if  $v$  is a vertex of  $\bar{\Gamma}_F$ , then either

- valency( $v$ ) = 4 =  $\varphi_4(v)$ , or
- valency( $v$ ) = 5,  $\varphi_3(v) = 3$ , and  $\varphi_4(v) = 2$ , or
- valency( $v$ ) = 6 =  $\varphi_3(v)$ .

Hence if  $\bar{\Gamma}_F$  has a vertex of valency 5 or 6, our assumption that  $\Delta(\alpha, \beta) \geq 7$  implies that it is incident to a trigon face with an edge of maximal weight, so we are done by Proposition 14.7.

Assume then that valency( $v$ ) = 4 =  $\varphi_4(v)$  for each vertex  $v$ . Then  $\bar{\Gamma}_F$  is rectangular and as the weight of the edges is 4 or less,  $\Delta(\alpha, \beta)$  is either 7 or 8. It follows that each vertex  $v$  of  $\bar{\Gamma}_F$  is incident to at least three edges of weight 4, so there is a quad face of  $\bar{\Gamma}_F$  with adjacent edges of maximal weight. Proposition 14.8 then shows that  $M$  is the figure eight knot exterior.  $\diamond$

## 16. COMPLETION OF THE PROOF OF THEOREM 1.2 WHEN $X^-$ IS NOT A TWISTED $I$ -BUNDLE

In this section we complete of the proof of Theorem 1.2 when  $X^-$  is not a twisted  $I$ -bundle.

**Proposition 16.1.** *Suppose that Assumptions 4.3 and 9.2 hold,  $F$  is separating but not a semi-fibre, and  $t_1^+ = t_1^- = 0$ . If  $X^-$  is not a twisted  $I$ -bundle, then  $\Delta(\alpha, \beta) \leq 5$ .*

**Proof.** Since  $X^-$  is not a twisted  $I$ -bundle,  $M$  is not the figure eight knot exterior.

Suppose that  $\Delta(\alpha, \beta) \geq 6$  and note that  $\Delta(\alpha, \beta) = 6$  by Proposition 15.1. Proposition 13.1 implies that  $d > 0$ . The weight of each edge in  $\bar{\Gamma}_F$  is at most 3 by Lemma 13.3 and therefore  $\bar{\Gamma}_F$  has no valency 3 vertices and each edge incident to a valency 4 vertex is of maximal weight.

If there is a vertex  $v$  of  $\Gamma_F$  such that  $\mu(v) > 2\Delta(\alpha, \beta) - 4$ , Proposition 12.2(1) of [BGZ2] implies that  $\bar{\Gamma}_F$  has a trigon face with an edge of weight 3. But then  $M$  would be the figure eight knot exterior by Proposition 14.7, a contradiction.

Corollary 12.4 of [BGZ2] now shows that  $\mu(v) = 2\Delta(\alpha, \beta) - 4$  for each vertex  $v$  and by Proposition 12.5 of that paper, for each vertex  $v$  of  $\bar{\Gamma}_F$  either

- valency( $v$ ) = 4 =  $\varphi_4(v)$ , or
- valency( $v$ ) = 5,  $\varphi_3(v) = 3$ , and  $\varphi_4(v) = 2$ , or
- valency( $v$ ) = 6 =  $\varphi_3(v)$ .

Applying Propositions 14.7 and 14.8 we see that  $\bar{\Gamma}_F$  has no vertices of valency 4 or 5. It follows that  $\bar{\Gamma}_F$  is hexagonal. Each of its edges has weight 2 by Proposition 14.7 while Proposition 11.2 of [BGZ2] shows that some edge  $\bar{e}$  of  $\bar{\Gamma}_F$  is negative. Then  $d = 1$  by Lemma 13.3(1)(c) and as every trigon face of  $\bar{\Gamma}_F$  has a positive edge we can apply Proposition 14.9 to see that  $M$  is the figure eight knot exterior. This final contradiction completes the proof.  $\diamond$

17. COMPLETION OF THE PROOF OF THEOREM 1.2 WHEN  $\Delta(\alpha, \beta) = 6$  AND  $d = 1$ 

We suppose that  $F$  is separating,  $\Delta(\alpha, \beta) = 6$ ,  $t_1^+ = t_1^- = 0$ , and  $d = 1$  in this section. By Proposition 16.1 we can assume that  $X^-$  is a twisted  $I$ -bundle and therefore each edge of  $\bar{\Gamma}_F$  has weight 2 or 4 by Lemma 13.3. We prove,

**Proposition 17.1.** *Suppose that Assumptions 4.3 and 9.2 hold,  $F$  is separating but not a semi-fibre, and  $t_1^+ = t_1^- = 0$ . If  $\Delta(\alpha, \beta) = 6$  and  $d = 1$ , then  $M$  is the figure eight knot exterior.*

The proof of this proposition follows from Lemmas 17.2 and 17.3 below. In order to set these lemmas up, recall that  $0 \leq \chi(Y) = \sum_v \chi(v)$  where the sum is over the vertices of  $\bar{\Gamma}_F$  and

$$\chi(v) = 1 - \frac{\text{valency}(v)}{2} + \sum_{v \in f} \frac{\chi(f)}{|\partial f|}$$

**Lemma 17.2.** *Suppose that  $X^-$  is a twisted  $I$ -bundle,  $\Delta(\alpha, \beta) = 6$ , and  $d = 1$ . If  $\bar{\Gamma}_F$  has a vertex  $v$  with  $\chi(v) > 0$ , then  $M$  is the figure eight knot exterior.*

**Proof.** Consider a vertex  $v$  of  $\bar{\Gamma}_F$  such that  $\chi(v) > 0$ . Then

$$0 < \chi(v) = 1 - \frac{\text{valency}(v)}{2} + \sum_{v \in f} \frac{\chi(f)}{|\partial f|} \leq 1 - \frac{\text{valency}(v)}{2} + \frac{\text{valency}(v)}{3} \leq 1 - \frac{\text{valency}(v)}{6}$$

so that  $\text{valency}(v) \leq 5$ . On the other hand, the assumption that  $\Delta(\alpha, \beta) = 6$  implies that the vertices of  $\bar{\Gamma}_F$  have valency 3 or more. Thus the valency of  $v$  is either 3, 4, or 5.

**Case 1.  $v$  has valency 5.**

The reader will verify that  $\chi(v) > 0$  is equivalent to requiring that  $\varphi_3(v) \geq 4$ . Then each edge incident to  $v$  is incident to a trigon face of  $\bar{\Gamma}_F$ . On the other hand, as  $\Delta(\alpha, \beta) = 6$  and  $v$  has valency 5, there is at least one edge incident to  $v$  having weight 4. Proposition 14.7 then shows that  $M$  is the figure eight knot exterior.

**Case 2.  $v$  has valency 4.**

Since  $\Delta(\alpha, \beta) = 6$ , two edges incident to  $v$  have weight 2 and two have weight 4. The condition that  $\chi(v) > 0$  implies that  $\varphi_3(v) \geq 1$ . By Proposition 14.7, we may assume that  $\varphi_3(v) = 1$  and the weights of the edges incident to  $v$  are 2, 2, 4, 4 in cyclic order. The condition that  $\chi(v) > 0$  then implies that either  $\varphi_4(v) = 3$  or  $\varphi_4(v) = 2$  and  $\varphi_5(v) = 1$ . In the former case there is a quad face incident to  $v$  which has adjacent edges of maximal weight, and so Proposition 14.8 shows that  $M$  is the figure eight knot exterior. In the latter case there is either a quad face or a 5-gon face incident to  $v$  with adjacent edges of weight 4. We may now apply Propositions 14.8 and 14.12 to see that  $M$  is the figure eight knot exterior.

**Case 3.  $v$  has valency 3.**

Since  $\Delta(\alpha, \beta) = 6$ , each of the edges incident to  $v$  has weight 4. The condition that  $\chi(v) > 0$  shows that at least one of the faces incident to  $v$  is a 3-gon or 4-gon or 5-gon. So we may apply Propositions 14.7, 14.8 and 14.12 respectively to see that  $M$  is the figure eight knot exterior.  $\diamond$

**Lemma 17.3.** *Suppose that  $X^-$  is a twisted  $I$ -bundle,  $\Delta(\alpha, \beta) = 6$ , and  $d = 1$ . If  $\chi(v) \leq 0$  for each vertex  $v$  of  $\bar{\Gamma}_F$ , then  $M$  is the figure eight knot exterior.*

**Proof.** Since  $0 \leq \chi(Y) = \sum_v \chi(v)$ , we have  $\chi(v) = 0$  for each vertex  $v$ . One can easily verify that for any vertex  $v$  with  $\chi(v) = 0$ , one of the following four cases holds:

- valency( $v$ ) = 3 and the number of edges of the three faces incident to  $v$  are (4, 6, 12), (4, 8, 8), (5, 5, 10), or (6, 6, 6);
- valency( $v$ ) = 4 =  $\varphi_4(v)$ ;
- valency( $v$ ) = 5,  $\varphi_3(v) = 3$ , and  $\varphi_4(v) = 2$ ;
- valency( $v$ ) = 6 =  $\varphi_3(v)$ .

By Proposition 14.10, we may assume that  $\bar{\Gamma}_F$  has no vertices of valency 5 or 6.

Suppose that  $\bar{\Gamma}_F$  has a vertex  $v$  of valency 3. Then each of the edges incident to  $v$  have weight 4, so by Propositions 14.7, 14.8 and 14.12 we may assume that  $\varphi_6(v) = 3$ . It follows that  $v$  cannot be connected to a valency 4 vertex by an edge of  $\bar{\Gamma}_F$ . In particular, the vertices of  $\bar{\Gamma}_F$  which cobound an edge with  $v$  have valency 3. It follows that if  $f$  is a 6-gon faces incident to  $v$ , each of its edges has weight 4.

Since  $q_+ \geq 3$ , no bigon face of  $\Gamma_F$  lying in  $X^+$  contains a red tile and there are no red tile bigons connecting adjacent edges of  $f$ . It follows that if an edge  $e$  of  $f$  has at least two red tiles incident to it, each of these tiles has a cross-arc in its boundary connecting  $e$  to another edge of  $f$ . But then it's easy to see that some edge of  $f$  is incident to at most one red tile. Corollary 14.11 then shows that  $M$  is the figure eight knot exterior.

Finally suppose that  $\bar{\Gamma}_F$  has no valency 3 vertices. In this case,  $\bar{\Gamma}_F$  is rectangular ([BGZ2, Proposition 11.5]) and the weights of edges at any of its vertices alternate 2, 4, 2, 4 (Proposition 14.8). By Corollary 14.11 we may assume that every edge of weight 4 intersects cross-arcs and thus there are no cross-arcs incident to a weight 2 edge. It follows that the two edges of a bigon face corresponding to a weight 2 edge is incident to at most two red tiles. Corollary 14.11 then implies that  $M$  is the figure 8 exterior.  $\diamond$

## 18. THE CASE THAT $F$ SEPARATES BUT NOT A SEMI-FIBRE, $t_1^+ = t_1^- = 0$ , $d \neq 1$ , AND $M(\alpha)$ IS VERY SMALL

In this section we suppose that  $F$  is separating, though not a semi-fibre,  $t_1^+ = t_1^- = 0$ ,  $d \neq 1$ , and  $M(\alpha)$  is a small Seifert manifold which is very small. We use character variety methods to prove the following proposition.

**Proposition 18.1.** *Suppose that Assumptions 4.3 and 9.2 hold,  $F$  is separating but not a semi-fibre,  $t_1^+ = t_1^- = 0$ , and  $d \neq 1$ . If  $M(\alpha)$  is a very small Seifert manifold, then*

$$\Delta(\alpha, \beta) \leq \begin{cases} 1 & \text{if } d = 0 \text{ or } M(\alpha) \text{ is of } C\text{-type} \\ 2 & \text{if } \alpha \text{ is of } D\text{-type} \\ 3 & \text{if } \alpha \text{ is of } T\text{-type, } O\text{-type or } I\text{-type, or } (a, b, c) = (2, 3, 6), (2, 4, 4) \text{ or } (3, 3, 3) \end{cases}$$

The case that  $d = 0$  is handled in Proposition 13.1, so we suppose that  $d \geq 2$  below.

Recall that  $\widehat{X}^\epsilon$  has base orbifold  $D^2(p_\epsilon, q_\epsilon)$  where  $2 \leq p_\epsilon \leq q_\epsilon$ . Write  $\pi_1(D^2(p_\epsilon, q_\epsilon)) \cong \mathbb{Z}/p_\epsilon * \mathbb{Z}/q_\epsilon$  and choose generators  $a_\epsilon$  of  $\mathbb{Z}/p_\epsilon$  and  $b_\epsilon$  of  $\mathbb{Z}/q_\epsilon$  for which  $a_\epsilon b_\epsilon$  generates  $\pi_1(\partial D^2(p_\epsilon, q_\epsilon))$ . There is an epimorphism

$$\pi_1(M(\beta)) \xrightarrow{\varphi} \Delta(p_+, q_+, d) *_\psi \Delta(p_-, q_-, d)$$

where  $\varphi$  is the quotient by  $\langle\langle \phi_+, \phi_- \rangle\rangle_{\pi_1(M(\beta))}$  and  $\psi : \varphi(\pi_1(\widehat{F})) \rightarrow \varphi(\pi_1(\widehat{F}))$  is the isomorphism determined by the gluing map  $\partial \widehat{X}^+ \rightarrow \partial \widehat{X}^-$ . The reader will verify that for either  $\epsilon$ ,  $\varphi(\pi_1(\widehat{F}))$  is the copy  $\mathbb{Z}/d$  contained in  $\Delta(p_\epsilon, q_\epsilon, d)$  corresponding to  $(a_\epsilon b_\epsilon)^d$ .

If  $\beta^* \in \pi_1(\partial M)$  is a dual class to  $\beta$ , then  $\varphi(\beta^*) = a_+(a_+ b_+)^k a_-$  for some integer  $k$ .

**Lemma 18.2.** *Suppose that  $t_1^+ = t_1^- = 0$  and  $d \geq 2$ . If  $d' > 1$  is a divisor of  $d$ , there is a non-trivial curve  $X_{d'} \subset X_{PSL_2}(M(\beta)) \subset X_{PSL_2}(M)$  such that*

- (1)  $\tilde{f}_{\beta^*}$  has a pole at each ideal point of  $X_{d'}$ ;
- (2)(a)  $X_{d'}$  has one ideal point if  $(p_-, q_-, d') = (2, 2, 2)$ , and therefore  $s_{X_{d'}} \geq 1$ ;
- (b)  $X_{d'}$  has two ideal points if  $(p_-, q_-, d') \neq (2, 2, 2)$ , and therefore  $s_{X_{d'}} \geq 2$ .
- (3)  $X_{d'}$  is not strictly non-trivial if and only if  $(p_+, q_+, d') = (2, 4, 4)$  and  $(p_-, q_-, d')$  is either  $(2, 2, 4)$  or  $(2, 4, 4)$ .

*Proof.* If  $d' > 1$  is a positive integer dividing  $d$  we can use the surjective composition of homomorphisms

$$\pi_1(M(\beta)) \xrightarrow{\varphi} \Delta(p_+, q_+, d) *_{\mathbb{Z}/d} \Delta(p_-, q_-, d) \rightarrow \Delta(p_+, q_+, d') *_{\mathbb{Z}/d'} \Delta(p_-, q_-, d')$$

to construct a curve  $X_{d'} \subset X_{PSL_2}(M(\beta)) \subset X_{PSL_2}(M)$ . Lemma 6.3(3) shows that assertion (1) of the lemma holds and further, that  $X_{d'}$  has two ideal points unless  $(p_\epsilon, q_\epsilon, d) = (2, 2, 2)$  for some  $\epsilon$ , and otherwise one. Since  $(p_+, q_+) \neq (2, 2)$ , assertion (2) of the lemma holds. Lemma 6.3(2) shows that  $X_{d'}$  is not strictly non-trivial if and only if  $(p_\epsilon, q_\epsilon, d') \in \{(2, 2, d'), (2, 4, 4)\}$  for both  $\epsilon$ . Since  $(p_+, q_+) \neq (2, 2)$ , the latter condition is equivalent to  $(p_+, q_+, d') = (2, 4, 4)$  and  $(p_-, q_-, d') \in \{(2, 2, 4), (2, 4, 4)\}$ . Thus assertion (3) of the lemma holds.  $\diamond$

*Proof of Proposition 18.1.* As mentioned above, the case  $d = 0$  is handled by Proposition 13.1. Suppose then that  $d \geq 2$ .

If  $d' > 1$  is a divisor of  $d$  and  $X_{d'} \subset X_{PSL_2}(M)$  is a non-trivial curve obtained as in Lemma 18.2, then

$$\Delta(\alpha, \beta) s_{X_{d'}} = \|\alpha\|_{X_{d'}}$$

by (5.0.2) and further,  $s_{X_{d'}} \neq 0$ . Hence if  $\pi_1(M(\alpha))$  is cyclic, then  $\|\alpha\|_{X_{d'}} = s_{X_{d'}}$  by [BCSZ2, Proposition 8.1], so  $\Delta(\alpha, \beta) = 1$ .

Next suppose that  $M(\alpha)$  is a prism manifold. That is,  $\alpha$  is of  $D$ -type. If  $X_{d'}$  is strictly non-trivial, then  $\Delta(\alpha, \beta)s_{X_{d'}} = \|\alpha\|_X \leq 2s_{X_{d'}}$  ([BCSZ2, Proposition 8.1]), so  $\Delta(\alpha, \beta) \leq 2$ . On the other hand, if  $X_{d'}$  is not strictly non-trivial, then  $(p_+, q_+, d') = (2, 4, 4)$  and  $(p_-, q_-, d')$  is  $(2, 2, 4)$  or  $(2, 4, 4)$  by Lemma 18.2(3). In either case,  $X_2$  is a strictly non-trivial curve, so  $\Delta(\alpha, \beta) \leq 2$  as above.

Finally suppose that  $M(\alpha)$  is neither  $C$ -type nor  $D$ -type and recall from the proof of Proposition 10.7 that if  $\rho : \pi_1(M(\alpha)) \rightarrow PSL_2(\mathbb{C})$  is an irreducible representation, then

$$\text{image}(\rho) \cong \begin{cases} T_{12} & \text{if } \alpha \text{ is of } T\text{-type or } (a, b, c) = (3, 3, 3) \\ D_3 \text{ or } O_{24} & \text{if } \alpha \text{ is of } O\text{-type} \\ I_{60} & \text{if } \alpha \text{ is of } I\text{-type} \\ D_3 \text{ or } T_{12} & \text{if } (a, b, c) = (2, 3, 6) \\ D_2 \text{ or } D_4 & \text{if } (a, b, c) = (2, 4, 4) \end{cases}$$

Further, in each of these five possibilities at most two such representations have isomorphic images and if two, either  $\alpha$  has  $I$ -type and the image is  $I_{60}$  or  $(a, b, c) = (2, 4, 4)$  and the image is  $D_4$ . Note, in particular, that the image of  $\rho$  is finite with elements of order at most 5.

Suppose that  $(p_-, q_-, d') \neq (2, 2, 2)$ , so that  $s_{X_{d'}} \geq 2$  and no representation with character lying on  $X_{d'}$  has image isomorphic to  $D_2$ . If  $X_{d'}$  is strictly non-trivial, we can apply Proposition 5.2(2) to see that  $\Delta(\alpha, \beta) \leq 2$  when  $\alpha$  is of  $T$ -type,  $O$ -type or  $(a, b, c)$  is either  $(2, 3, 6)$ ,  $(2, 4, 4)$ , or  $(3, 3, 3)$  and that  $\Delta(\alpha, \beta) \leq 3$  when it is of  $I$ -type.

If  $(p_-, q_-, d') \neq (2, 2, 2)$  and  $X_{d'}$  is not strictly non-trivial, then as in the prism manifold case we know that  $(p_+, q_+, d') = (2, 4, 4)$  and  $(p_-, q_-, d')$  is either  $(2, 2, 4)$  or  $(2, 4, 4)$ . In either case,  $X_2$  is a strictly non-trivial curve with  $s_{X_2} \geq 2$  and as in the previous paragraph,  $\Delta(\alpha, \beta) \leq 2$  when  $\alpha$  is of  $T$ -type,  $O$ -type or  $(a, b, c)$  is either  $(2, 3, 6)$ ,  $(2, 4, 4)$ , or  $(3, 3, 3)$ , and that  $\Delta(\alpha, \beta) \leq 3$  when it is of  $I$ -type.

Next suppose that  $(p_-, q_-, d') = (2, 2, 2)$ . In this case  $X_{d'} = X_2$  is strictly non-trivial and the image of each representation whose character lies on  $X_2$  contains a copy of  $\Delta(2, 2, 2)$  as a proper subgroup, which excludes the possibility that the image is  $D_2$  or  $D_3$ . It then follows from Proposition 5.2(2) that  $\Delta(\alpha, \beta) \leq 3$  when  $\alpha$  is of  $T$ -type or  $O$ -type or  $(a, b, c)$  is either  $(2, 3, 6)$ ,  $(2, 4, 4)$  or  $(3, 3, 3)$ .

Finally suppose that  $\alpha$  has  $I$ -type. Proposition 5.2 shows that to obtain the inequality  $\Delta(\alpha, \beta) \leq 3$ , it suffices to prove  $|J_{X_2}(\alpha)| \leq 1$ .

Suppose then that  $|J_{X_2}(\alpha)| = 2$ . There cannot be another non-trivial curve  $X_* \subset X_{PSL_2}(M(\beta)) \subset X_{PSL_2}(M)$  as otherwise  $|J_{X_*}(\alpha)| = \emptyset$ , so  $\Delta(\alpha, \beta) = 1$  (Proposition 5.2). In particular, since killing  $\pi_1(\widehat{F})$  in  $\pi_1(M(\beta))$  yields  $\mathbb{Z}/\gcd(p_+, q_+) * \mathbb{Z}/2$ , we must have  $\gcd(p_+, q_+) = 1$ . Also, the discussion in §6.1 shows that  $(p_+, q_+) = (2, 3)$ , so  $\widehat{X}^+$  is a trefoil exterior and  $(p_+, q_+, d) = (2, 3, 2)$ . We claim that there are no  $I$ -type filling slopes in this situation.



The assumption that  $(p_-, q_-, d') = (2, 2, 2)$  implies that  $X^-$  is a twisted  $I$ -bundle ([BGZ2, Proposition 7.5]) and therefore  $X^-$  is a twisted  $I$ -bundle over the Klein bottle. Then  $H_1(\widehat{X}^-) \cong \mathbb{Z} \oplus \mathbb{Z}/2$  where the  $\mathbb{Z}$  factor is generated by a class  $\xi$  such that  $2\xi = [\phi_-]$  and the  $\mathbb{Z}/2$  factor is generated by  $[\phi'_-]$ .

Now if  $[\phi_+] = m[\phi_-] + n[\phi'_-]$ , then  $|n| = \Delta(\phi_+, \phi_-) = d = 2$ , so  $[\phi_+] = 2m\xi \pm 2[\phi'_-] \in H_1(\widehat{X}^-)$ . Hence  $[\phi_+]$  maps to zero in  $H_1(\widehat{X}^-; \mathbb{Z}/2)$ . On the other hand, as the fibre class in a trefoil knot exterior,  $[\phi_+]$  maps to zero in  $H_1(\widehat{X}^+; \mathbb{Z}/2)$ . Consideration of the Mayer-Vietoris sequence for  $M(\beta) = \widehat{X}^+ \cup \widehat{X}^-$  then shows that the first (mod 2) Betti number of  $M(\beta)$  is 2. Hence that of  $M$  is at least 2, and so that of  $M(\alpha)$  is at least 1. In particular,  $\alpha$  cannot be an  $I$ -type filling slope (cf. [BZ1, page 117]), contrary to our assumptions.

We conclude that  $|J_{X_2}(\alpha)| \leq 1$  and therefore  $\Delta(\alpha, \beta) \leq 3$ .  $\diamond$

19. THE CASE THAT  $F$  SEPARATES BUT IS NOT A SEMI-FIBRE,  $t_1^+ = t_1^- = 0$ ,  $d > 1$ , AND  $M(\alpha)$  IS NOT VERY SMALL

In this final section we complete the proof of Theorem 1.2 with the following proposition.

**Proposition 19.1.** *Suppose that Assumptions 4.3 and 9.2 hold,  $F$  is separating but not a semi-fibre,  $t_1^+ = t_1^- = 0$ , and  $d > 1$ . If  $M(\alpha)$  is a small Seifert manifold but not very small, then  $\Delta(\alpha, \beta) \leq 5$ .*

We suppose that the hypotheses of the proposition hold for the remainder of this section. Since  $d > 1$ ,  $M$  is not the figure eight knot exterior, and so  $\Delta(\alpha, \beta) \leq 6$  by Proposition 15.1. We assume below that  $\Delta(\alpha, \beta) = 6$  in order to derive a contradiction. Proposition 16.1 then implies that  $X^-$  is a twisted  $I$ -bundle.

**19.1. Involutions on  $M$  and its fillings.** For each  $\epsilon \in \{+, -\}$ , recall the essential annulus  $A^\epsilon$  which separates  $\widehat{X}^\epsilon$  into a union of two solid tori which contains  $k_\epsilon = K_\beta \cap \widehat{X}^\epsilon$  as an essential arc. Recall as well that  $\widehat{X}^+$  is Seifert fibred over  $D^2(p_+, q_+)$  with  $p_+ \geq 3$  and  $q_+ \geq 2$ , and  $\widehat{X}^-$  is Seifert fibred over  $D^2(2, 2)$ .

Let  $V_a$  and  $V_b$  be the two solid tori which arise as the components of  $\widehat{X}^+ \setminus A^+$  where  $A^+$  has winding number  $p_+$  in  $V_a$  and  $q_+$  in  $V_b$ .

There is an involution  $\tau_+$  on  $\widehat{X}^+$  under which each of  $V_a, V_b, A^+, k_+$  is invariant. More precisely,

- the restriction of  $\tau_+$  to both  $V_a$  and  $V_b$  is a standard involution of a solid torus whose fixed point set is a pair of arcs each contained in a meridional disk of the solid torus;
- the restriction of  $\tau_+$  to  $A^+$  is a  $\pi$ -rotation with two fixed points (cf. Figure 45);
- the restriction of  $\tau_+$  to  $k_+$  is a rotation about a fixed point (cf. Figure 45);
- the restriction of  $\tau_+$  to  $\widehat{F}$  is a hyperelliptic involution which exchanges the two points  $\partial k_+$ ;

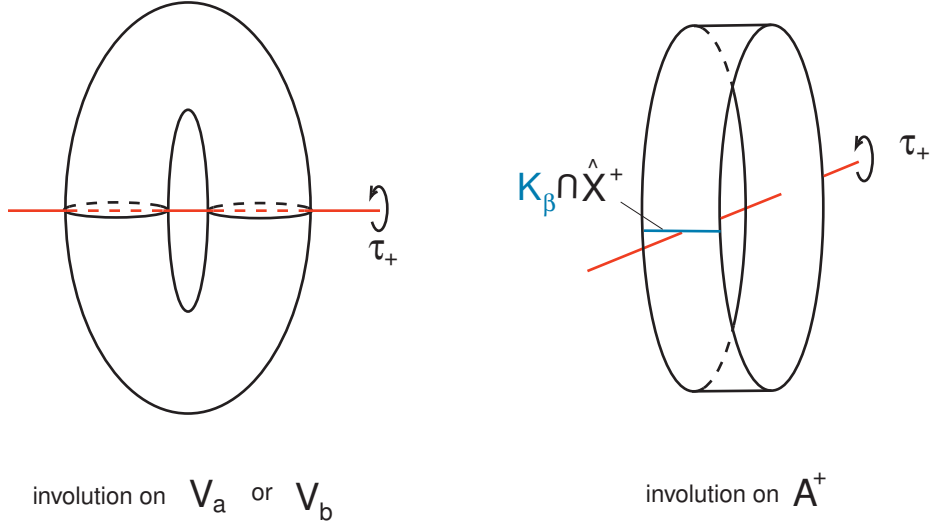

FIGURE 45.

- the quotient space of  $\widehat{X}^+$  under  $\tau_+$  is a 3-ball whose branched set is shown in Figure 46(1).

There is an analogous involution  $\tau_-$  on  $\widehat{X}^-$  with quotient space as shown in Figure 46(2), at least up to homeomorphism.

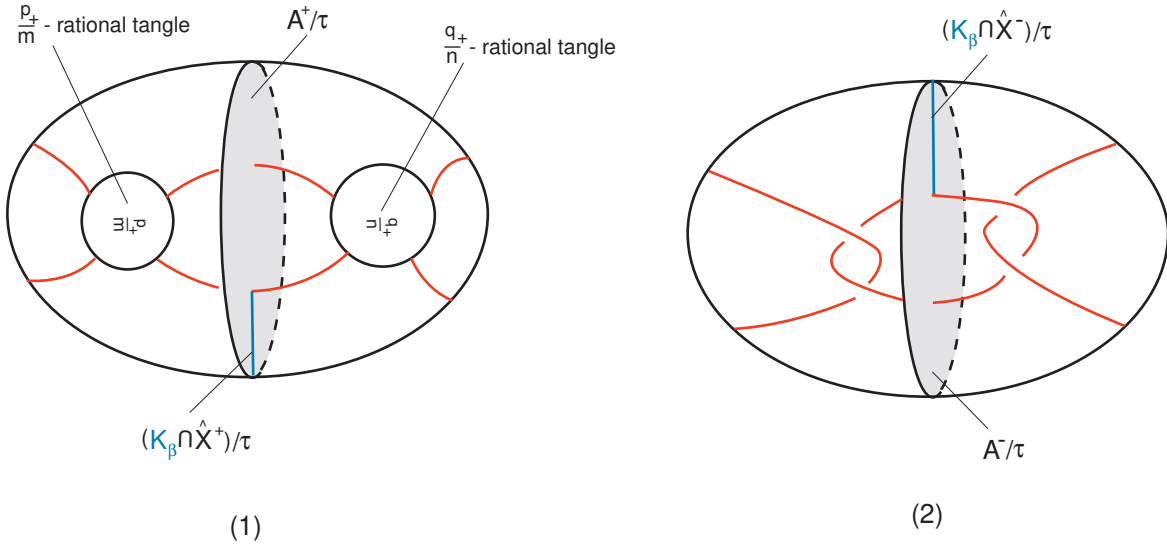

FIGURE 46.

Let  $f : \partial\widehat{X}^+ \rightarrow \partial\widehat{X}^-$  be the gluing map yielding  $M(\beta) = \widehat{X}^+ \cup \widehat{X}^-$ . Then as both  $\tau_-|_{\widehat{F}}$  and  $f \circ \tau_+|_{\widehat{F}} \circ f^{-1}$  are hyperelliptic involutions exchanging the two points  $\partial k_+ = \partial k_-$ , there is a homeomorphism  $g$  of  $\widehat{X}^-$  isotopic (rel  $\partial k_-$ ) to the identity such that

$$f \circ (\tau_+|_{\partial\widehat{X}^+}) \circ f^{-1} = (g \circ \tau_- \circ g^{-1})|_{\partial\widehat{X}^-}$$

Hence, up to replacing  $\tau_-$  by  $g \circ \tau_- \circ g^{-1}$ , we may assume that the restriction of  $\tau_+$  to  $(\partial\widehat{X}^+, k_+)$  equals that of  $\tau_-$  to  $(\partial\widehat{X}^-, k_-)$ . Let

$$\tau_\beta : (M(\beta), K_\beta) \rightarrow (M(\beta), K_\beta)$$

be the involution obtained by gluing  $\tau_+$  and  $\tau_-$  together along  $\widehat{F}$ .

We may assume that the filling solid torus  $V_\beta$  is  $\tau_\beta$ -invariant and thus obtain an involution  $\tau$  of  $M = M(\beta) \setminus V_\beta$ . The quotient spaces  $M(\beta)/\tau_\beta$  and  $M/\tau$  and their branched sets are as shown in Figure 47. The involution  $\tau$  extends to an involution  $\tau_\gamma$  on any  $\gamma$ -filling of  $M$  along  $\partial M$  and the branched set in  $M(\gamma)/\tau_\gamma$  is obtained by filling  $M/\tau$  with a corresponding rational tangle along  $\partial M/\tau$ . It follows that  $M(\gamma)$  is a 2-fold cover of  $S^3$  branched along a link  $L_\gamma$ .

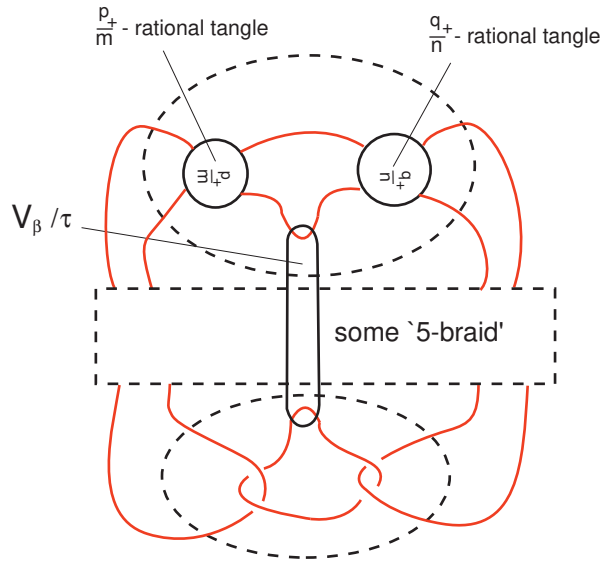

FIGURE 47.

**19.2. Branched sets of the involutions on small Seifert manifolds.** Suppose that  $W$  is Seifert fibred with base orbifold  $S^2(a, b, c)$  where  $a, b, c \geq 2$ , but is not a prism manifold, which is the 2-fold cover of  $S^3$  branched over a link  $L$ . By the orbifold theorem we may assume that the associated covering involution,  $\theta$  say, preserves the Seifert structure on  $W$ . We distinguish two cases. If  $\theta$  reverses the orientations of the Seifert fibres of  $W$  then  $L$  is a Montesinos link ([Mo]). If it preserves their orientations, the Seifert structure on  $W$  quotients to one on  $S^3$  for which  $L$  is a union of fibres. In the former case we say that  $L$  is a Montesinos link  $L$  of type  $(a, b, c)$ . In the latter case we say that  $L$  is a *Seifert link*.

Our goal in this subsection is to describe more precisely the possibilities for  $L$  when it is a Seifert link. We begin with some standard examples of Seifert links and the base orbifolds of their branched covers.

**Example 19.2.** If  $L$  is a  $(p, q)$  torus knot, then its 2-fold branched cover has base orbifold

$$S^2(a, b, c) \cong \begin{cases} S^2(2, p, q) & \text{if } pq \text{ is odd} \\ S^2(\frac{p}{2}, q, q) & \text{if } p \text{ is even} \\ S^2(\frac{q}{2}, p, p) & \text{if } q \text{ is even} \end{cases}$$

**Example 19.3.** If  $L = U \cup K \subset S^3$  is a two component link where  $U$  is an unknot and  $K$  is a  $(p, q)$ -cable of  $U$  (i.e.  $K$  is isotopic in  $S^3 - U$  into the boundary of a regular neighbourhood  $N(U)$  of  $U$  as a  $(p, q)$ -torus knot with winding number  $q$  in  $N(U)$ ), then we say  $K$  is a  $(p, q)$ -torus knot with respect to  $U$ . In this case, the linking number between  $U$  and  $K$  is  $p$ . The 2-fold branched cover of  $L$  has base orbifold

$$S^2(a, b, c) \cong \begin{cases} S^2(q, p, p) & \text{if } q \text{ is odd} \\ S^2(2, p, 2q) & \text{if } q \text{ is even} \end{cases}$$

**Example 19.4.** If  $L = U_0 \cup U_1 \cup K \subset S^3$  is a three component link where  $U_0 \cup U_1$  is a Hopf link and  $K$  is a  $(p, q)$ -torus knot which is isotopic in  $S^3 - (U_0 \cup U_1)$  into the boundary of a regular neighbourhood  $N(U_0)$  of  $U_0$ , then we say that  $K$  is a  $(p, q)$ -torus knot with respect to  $U_0 \cup U_1$ . The 2-fold branched cover of  $L$  has base orbifold

$$S^2(a, b, c) \cong S^2(2, 2p, 2q)$$

The following lemma is a consequence of [BGZ3, Lemma 4.3] and the list of the base orbifolds of the 2-fold branched covers of the Seifert links in the three examples above.

**Lemma 19.5.** *Let  $W$  and  $\theta$  be as above. Suppose that  $\theta$  preserves the orientations of the Seifert fibres of  $W$  and endow  $W/\tau$  with the induced Seifert structure. Assume as well that  $W/\theta = S^3$  and let  $L_\theta \subset W/\tau \cong S^3$  be the branched set of  $\theta$ .*

- (1)  $L_\theta$  is a union of at most three Seifert fibres of  $S^3$ . Moreover at least one component of  $L_\theta$  is a regular fibre.
- (2) If  $|L_\theta| = 1$ , then either
  - (i)  $(a, b, c) = (2, p, q)$  where  $p$  and  $q$  are odd,  $\gcd(p, q) = 1$ , and  $L_\theta$  is a  $(p, q)$  torus knot, or
  - (ii)  $(a, b, c) = (p/2, q, q)$  where  $p$  is even,  $\gcd(p, q) = 1$ , and  $L_\theta$  is a  $(p, q)$ -torus knot.
- (3) If  $|L_\theta| = 2$ , then either
  - (i)  $(a, b, c) = (2, p, 2q)$  where  $q$  is even,  $\gcd(p, q) = 1$ , and  $L_\theta$  is the union of an unknot  $U$  and a  $(p, q)$ -torus knot with respect to  $U$ , or
  - (ii)  $(a, b, c) = (q, p, p)$  where  $q$  is odd,  $\gcd(p, q) = 1$ , and  $L_\theta$  is the union of an unknot  $U$  and a  $(p, q)$ -torus knot with respect to  $U$ .
- (4) If  $|L_\theta| = 3$ , then  $(a, b, c) = (2, 2p, 2q)$  where  $\gcd(p, q) = 1$  and  $L_\theta$  is the union of a Hopf link and a  $(p, q)$ -torus knot  $K$  with respect to  $L_\theta - K$ .  $\diamond$

**19.3. The proof of Proposition 19.1.** Suppose that  $M(\alpha)$  is Seifert fibred with base orbifold  $S^2(a, b, c)$  where  $a, b, c \geq 2$ , but is not a prism manifold. We know that with respect to the involution  $\tau_\alpha$  constructed in §19.1,  $M(\alpha)$  is a 2-fold branched cover of  $(S^3, L_\alpha)$  where  $L_\alpha$  is either a Montesinos link or a link whose exterior is Seifert fibred.

As  $\Delta(\alpha, \beta) = 6$  is even,  $L_\alpha$  contains a trivial component  $U_0$ , as shown in Figure 48(1), where  $L_\alpha - U_0$  is a Montesinos link whose 2-fold branched cover is obtained by Dehn filling  $\widehat{X}^+$  with a slope of distance  $d$  from  $\phi_+$ . Thus  $L_\alpha - U_0$  is a Montesinos link of type  $(p_+, q_+, d)$  (cf. Figure 48(2)). As  $d > 1$ , the fundamental group of the 2-fold branched cover of  $L_\alpha - U_0$  is not cyclic, so  $L_\alpha - U_0$  is not a 2-bridge link, and therefore  $L_\alpha$  cannot be a Montesinos link of three cyclically composed rational tangles. Hence  $L_\alpha$  must be a Seifert link of two or three components. In particular,  $\tau_\alpha$  can be assumed to preserve the orientations of the Seifert fibres of  $M(\alpha)$ , so that Lemma 19.5 applies to our situation. Then  $L_\alpha - U_0$  has either one or two components.

### Case 1. $K = L_\alpha - U_0$ is a knot

If  $K = L_\alpha - U_0$  is a knot, it is both a torus knot and a Montesinos knot of type  $(p_+, q_+, d)$ . Therefore  $K$  is either the  $(-2, 3, 3)$ -pretzel knot or the  $(-2, 3, 5)$ -pretzel knot ([Oe]). Equivalently,  $K$  is either the  $(3, 4)$ -torus knot or, respectively, the  $(3, 5)$ -torus knot. Further, the linking number between  $U_0$  and  $K$  is an odd number (see Figure 48(2) and apply [BuZi, Remark 12.7]).

First suppose that  $K = T(3, 4)$ . Then  $K$  is a  $(3, 4)$ -torus knot with respect to  $U_0$ . Lemma 19.5 then shows that  $M(\alpha)$  has base orbifold  $S^2(2, 8, 3)$ . On the other hand, the 2-fold branched cover of  $K$  has base orbifold  $S^2(p_+, q_+, d) \cong S^2(2, 3, 3)$ , so  $(p_+, q_+, d)$  is either  $(2, 3, 3)$  or  $(3, 3, 2)$ .

If  $(p_+, q_+, d) = (2, 3, 3)$ , there is an epimorphism  $\pi_1(M(\beta)) \xrightarrow{\varphi} \Delta(2, 3, 3) *_{\psi} \Delta(2, 2, 3)$  and as in Lemma 18.2, we can build a strictly non-trivial curve  $X_0$  in  $X_{PSL_2}(M(\beta)) \subset X_{PSL_2}(M)$  which contains only irreducible characters and for which  $s_{X_0} \geq 2$ . Further,  $\tilde{f}_\alpha$  has a pole at each of ideal point of  $X_0$ . By [BeBo, Proposition 3.2],  $\Delta(2, 8, 3)$  has exactly four irreducible characters and therefore Proposition 5.2(2) implies that  $\Delta(\alpha, \beta) \leq 1 + \frac{8}{2} = 5$ , contrary to our assumptions.

If  $(p_+, q_+, d) = (3, 3, 2)$ , there is an epimorphism  $\pi_1(M(\beta)) \xrightarrow{\varphi} \Delta(3, 3, 2) *_{\psi} \Delta(2, 2, 2)$  and as above we can build a strictly non-trivial curve  $X_0$  in  $X_{PSL_2}(M(\beta)) \subset X_{PSL_2}(M)$  which contains only irreducible characters and for which  $s_{X_0} \geq 1$ . Further,  $\tilde{f}_\alpha$  has a pole at each of ideal point of  $X_0$ . Two of the four irreducible characters of  $\Delta(2, 8, 3)$  correspond to the discrete faithful representation  $\Delta(2, 8, 3) \rightarrow PSL_2(\mathbb{R}) \rightarrow PSL_2(\mathbb{C})$  and to the quotient map to  $\Delta(2, 2, 3)$ . Neither of these can lie on  $X_0$ , so Proposition 5.2(2) implies that  $\Delta(\alpha, \beta) \leq 1 + \frac{4}{1} = 5$ , contrary to our assumptions. Thus  $K \neq T(3, 4)$ .

Next suppose that  $K = T(3, 5)$ . By Lemma 19.5, the base orbifold of  $M(\alpha)$  is either  $S^2(3, 3, 5)$  or  $S^2(3, 5, 5)$ . Further, the base orbifold of the 2-fold branched cover of  $K$  is  $S^2(2, 3, 5)$ , so  $(p_+, q_+, d) = (2, 3, 5)$  or  $(2, 5, 3)$  or  $(3, 5, 2)$ . In any event, we can construct a strictly non-trivial curve  $X_0 \subset X_{PSL_2}(M)$  as above. In fact, since there are two conjugacy classes of elements of order 5 in  $PSL_2(\mathbb{C})$ , we can construct disjoint, strictly non-trivial curve  $X_0, X_1 \subset X_{PSL_2}(M)$ . Since  $\Delta(3, 3, 5)$  and  $\Delta(3, 5, 5)$  are generated by elements of odd order, no representation whose character lies on these curves can have image in  $\mathcal{N}$ . Hence if  $s_{X_j} = 1$  for some  $j$ , Proposition 5.1(3) implies that  $\Delta(\alpha, \beta)$  is odd, contrary to assumption. Thus  $s_{X_j} \geq 2$  for both  $j$ . Set  $X = X_0 \cup X_1$ . Then  $\|\cdot\|_X = \|\cdot\|_{X_0} + \|\cdot\|_{X_1}$  so that  $s_X = s_{X_0} + s_{X_1} \geq 4$ . Since  $\Delta(3, 3, 5)$  has exactly four irreducible characters and  $\Delta(3, 5, 5)$  exactly eight ([BeBo, Proposition 3.2]), we see

that  $\Delta(\alpha, \beta) \leq 1 + \frac{16}{4} = 5$ , a contradiction. We have therefore ruled out the possibility that  $L_\alpha - U_0$  is a knot.

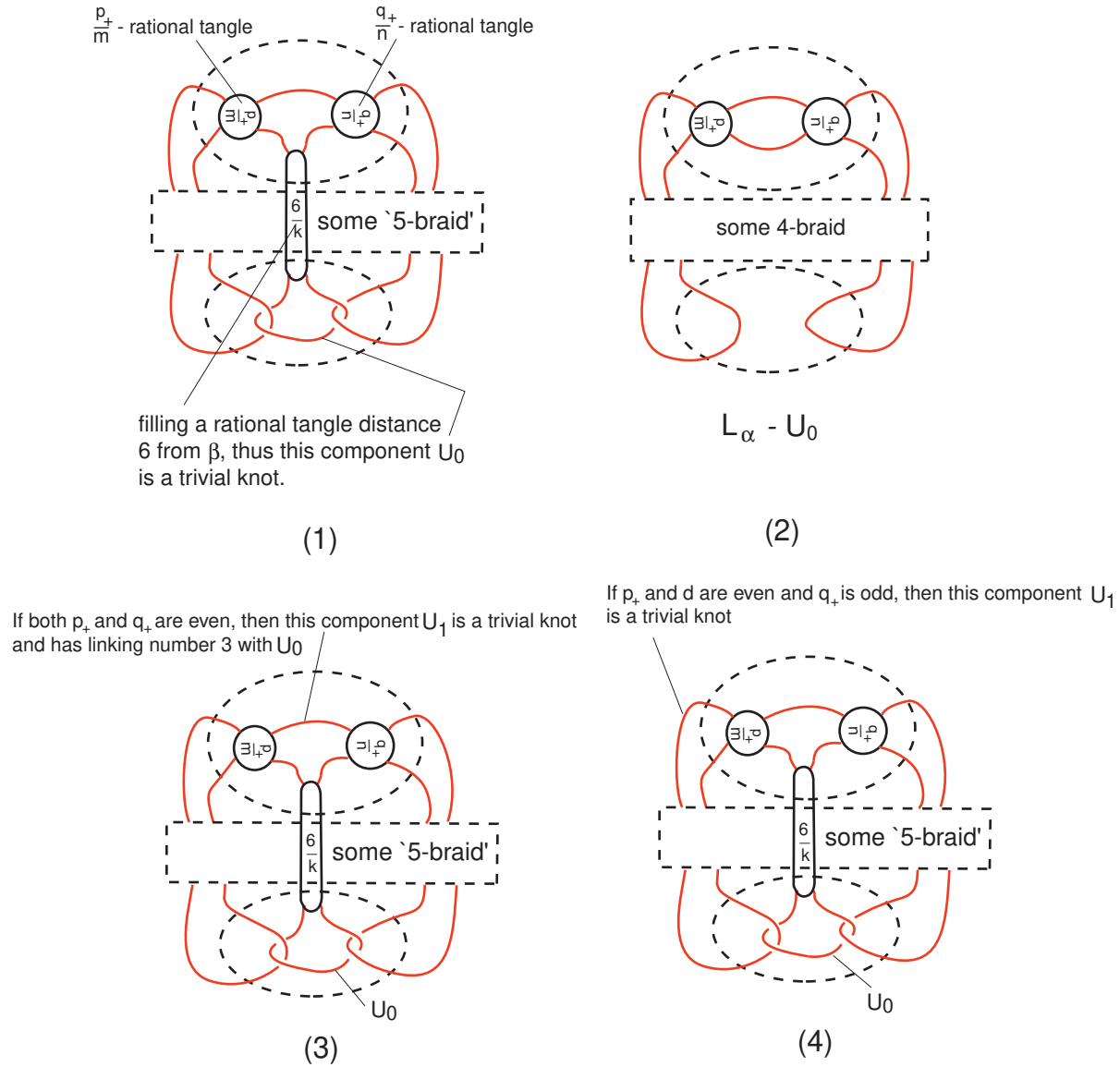

FIGURE 48.

**Case 2.  $L_\alpha - U_0$  is a two component link**

If  $L_\alpha - U_0$  is a two component link, then  $L_\alpha - U_0 = U_1 \cup K_1$  where  $U_1$  is a trivial knot and  $K_1$  is both a 2-bridge knot and a torus knot. Thus  $K_1$  is a  $(2, n)$  torus knot for some odd integer  $n$ . By Lemma 19.5(3),  $M(\alpha)$  is Seifert fibred over  $S^2(2, 4, 2q)$ .

Now  $K$  is either a  $(2, n)$  or  $(n, 2)$  torus knot with respect to  $U_1$ . Hence the base orbifold  $S^2(p_+, q_+, d)$  of the 2-fold branched cover of  $U_1 \cup K_1$  is either  $S^2(2, 4, n)$  or  $S^2(2, 2, n)$ , so exactly two of  $p_+, q_+$  and  $d$  are even. Now  $d$  cannot be odd, as otherwise  $p_+$  and  $q_+$  would both

be even. Inspection of Figure 48(3) then shows that the linking number between  $U_0$  and  $U_1$  is 3, which is impossible since  $U_1 \cup U_0$  is a Hopf link. We assume then that  $p_+$  and  $d$  are even. The case that  $q_+$  and  $d$  are even is treated similarly.

Since  $q_+ = n$  odd, we know that  $(p_+, q_+, d)$  is either  $(2, q_+, 2)$ ,  $(2, q_+, 4)$  or  $(4, q_+, 2)$ . Further,  $U_1$  is as illustrated in Figure 48(4) and  $K_1$  is a  $(2, q_+)$ -torus knot. We can also see from the figure that the linking number between  $U_0$  and  $K_1$  is even and therefore,  $K_1$  is a  $(q_+, 2)$ -torus knot with respect to  $U_1$ . Hence the base orbifold  $S^2(p_+, q_+, d)$  of the 2-fold branched cover of  $U_1 \cup K_1$  is  $S^2(2, 4, q_+)$ , so  $(p_+, q_+, d) = (2, q_+, 4)$  or  $(4, q_+, 2)$ .

If  $d = 4$ , we can build  $\lfloor \frac{q_+}{2} \rfloor$  strictly non-trivial disjoint curves  $X_0$  as above, each with  $s_{X_0} \geq 2$  (cf. §6.1). Hence if  $X$  is the union of these curves,  $s_X \geq q_+ - 1$ . Similarly if  $d = 2$ , we can build  $2\lfloor \frac{q_+}{2} \rfloor = q_+ - 1$  strictly non-trivial disjoint curves  $X_0$  as above, each with  $s_{X_0} \geq 1$ . Hence if  $X$  is the union of these curves, we again have  $s_X \geq q_+ - 1$ . By Lemma 19.5(2),  $M(\alpha)$  is Seifert fibred over  $S^2(2, 4, 2q_+)$  and by [BeBo, Proposition 3.2],  $\Delta(2, 4, 2q_+)$  has exactly  $q_+$  irreducible characters of representations with values in  $PSL_2(\mathbb{C})$ . Hence,  $\Delta(\alpha, \beta) \leq 1 + \frac{2q_+}{q_+-1} \leq 5$ , contrary to our assumptions. This rules out the possibility that  $L_\alpha - U_0$  is a two component link and completes the proof of Proposition 19.1.

## 20. PROOF OF THEOREM 1.8

The first proposition deals with the case where  $M(\alpha)$  is of  $C$ - or  $D$ -type.

**Proposition 20.1.** *Let  $M$  be a hyperbolic knot manifold with slopes  $\alpha$  and  $\beta$  on  $\partial M$  such that  $M(\beta)$  is toroidal and  $M(\alpha)$  is a very small Seifert manifold.*

- (1) *If  $M(\alpha)$  is of  $C$ -type then  $\Delta(\alpha, \beta) \leq 4$ .*
- (2) *If  $M(\alpha)$  is of  $D$ -type then*
  - (a)  $\Delta(\alpha, \beta) \leq 4$ , and
  - (b) *if  $M(\beta)$  is a torus semi-bundle then  $\Delta(\alpha, \beta) \leq 3$ .*

**Proof.** (1) If  $M(\alpha)$  is  $S^3$  then  $\Delta(\alpha, \beta) \leq 2$  by [GL1], if  $M(\alpha)$  is  $S^1 \times S^2$  then  $\Delta(\alpha, \beta) \leq 3$  by [Oh] and [Wu2], and if  $M(\alpha)$  is a lens space then  $\Delta(\alpha, \beta) \leq 4$  by [L3].

(2) (a) If  $M$  is a hyperbolic knot manifold such that  $M(\beta)$  is toroidal and  $M(\alpha)$  contains a Klein bottle, it follows from [V] (if  $\Delta(\alpha, \beta) > 5$ ) and [L2] (if  $\Delta(\alpha, \beta) = 5$ ), that  $M(\alpha)$  is toroidal. If  $M(\alpha)$  is of  $D$ -type then it contains a Klein bottle but is atoroidal. Hence  $\Delta(\alpha, \beta) \leq 4$ . Part (b) is Proposition 7.2 (5).  $\diamond$

**Proposition 20.2.** *Let  $M$  be a hyperbolic knot manifold which contains an  $m$ -punctured torus  $F$  with boundary slope  $\beta$ , that is not a fibre in  $M$  if  $m \geq 3$ . Let  $\alpha$  be a slope on  $\partial M$  such that  $M(\alpha)$  is a very small Seifert manifold. Then*

- (1)  $\Delta(\alpha, \beta) \leq 5$ , and

(2) if  $\Delta(\alpha, \beta) = 5$ , then either

(a)  $m = 1$ ,  $F$  is not a fibre,  $(M; \alpha, \beta) \cong (Wh(-3/2); -5, 0)$ , and  $M(\alpha)$  has base orbifold  $S^2(2, 3, 3)$ , or

(b)  $F$  is separating in  $M$  though not a semi-fibre.

**Proof.** This follows from Propositions 13.1 and 13.2 and Theorem 2.7 of [BGZ2], Theorem 1.3 of [BGZ3], Theorem 1.2 and Proposition 10.1, and the fact that the figure eight knot exterior admits no small Seifert Dehn fillings which are very small.  $\diamond$

Theorem 1.8 follows from Propositions 20.1, 7.2 and 20.2.

#### REFERENCES

- [Ad] C. Adams, *The noncompact hyperbolic 3-manifold of minimal volume*, Proc. Amer. Math. Soc. **100** (1987), 601–606.
- [BeBo] L. Ben Abdelghani and S. Boyer, *A calculation of the Culler-Shalen seminorms associated to small Seifert Dehn fillings*, Proc. London Math. Soc. **83** (2001), 235–256.
- [BoiBo] M. Boileau and S. Boyer, *On character varieties, sets of discrete characters, and non-zero degree maps*, Amer. J. Math. **134** (2012), 285–347.
- [BoiZie] M. Boileau and H. Zieschang, *Heegaard genus of closed orientable Seifert 3-manifolds*, Inv. Math **76** (1984), 455–468.
- [Bo] S. Boyer, *On the local structure of  $SL_2(\mathbb{C})$ -character varieties at reducible characters*, Top. Appl. **121** (2001), 383–413.
- [BCSZ1] S. Boyer, M. Culler, P. Shalen, and X. Zhang, *Characteristic submanifold theory and Dehn filling*, Trans. Amer. Math. Soc. **357** (2005), 2389–2444.
- [BCSZ2] \_\_\_\_\_, *Characteristic subvarieties, character varieties, and Dehn fillings*, Geometry & Topology **12** (2008) 233–297.
- [BGZ1] S. Boyer, C. McA. Gordon and X. Zhang, *Dehn fillings of large hyperbolic 3-manifolds*, J. Diff. Geom. **58** (2001), 263–308.
- [BGZ2] \_\_\_\_\_, *Characteristic Submanifold Theory and Toroidal Dehn Filling*, Adv. Math. **230** (2012), 1673–1737
- [BGZ3] \_\_\_\_\_, *Dehn fillings of knot manifolds containing essential once-punctured tori*, Trans. Amer. Math. Soc. **366** (2014) 341–393.
- [BZ1] S. Boyer and X. Zhang, *Finite Dehn surgery on knots*, J. Amer. Math. Soc. **9** (1996), 1005–1050.
- [BZ2] \_\_\_\_\_, *On Culler-Shalen seminorms and Dehn fillings*, Ann. Math. **148** (1998), 737–801.
- [BuZi] G. Burde and H. Zieschang, *Knots*, de Gruyter Studies in Mathematics (1985).
- [CDGW] M. Culler, N.M. Dunfield, M. Goemer, and J. R. Weeks, *SnapPy, a computer program for studying the geometry and topology of 3-manifolds*, <https://snappy.computop.org>
- [CGLS] M. Culler, C. M. Gordon, J. Luecke and P. Shalen, *Dehn surgery on knots*, Ann. of Math. **125** (1987) 237–300.
- [Ga] D. Gabai, *Foliations and the topology of 3-manifolds II*, J. Diff. Geom. **26** (1987) 1713–1790.
- [Go1] C. McA. Gordon, *Boundary slopes of punctured tori in 3-manifolds*, Trans. Amer. Math. Soc. **350** (1998) 461–478.
- [Go2] \_\_\_\_\_, *Dehn filling: a survey*, in Knot Theory, Banach Center Publications 42, Institute of Mathematics, Polish Academy of Sciences, Warsaw, 1998, 129–144.



- [GL1] C. McA. Gordon and J. Luecke, *Dehn surgeries on knots creating essential tori, I*, *Comm. Anal. Geom.* **4** (1995), 597–644.
- [GL2] \_\_\_\_\_, *Non-integral toroidal Dehn surgeries*, *Comm. Anal. Geom.* **12** (2004), 417–485.
- [GW] C. McA. Gordon and Y.-Q. Wu, *Toroidal Dehn fillings on hyperbolic 3-manifolds*, *Mem. Amer. Math. Soc.* **194** (2008), no.909.
- [GW2] \_\_\_\_\_, *Toroidal and annular Dehn fillings*, *Proceedings of the London Math. Soc.* **78** (1999) 662–700.
- [Ha] A. Hatcher, *Notes on basic 3-manifold topology*, Course notes, available at <https://pi.math.cornell.edu/hatcher>.
- [He] J. Hempel, *3-Manifolds*, *Ann. Math. Studies* **86**, Princeton University Press, 1976.
- [Ja] W. Jaco, *Lectures on three-manifold topology*, *CBMS Regional Conf. Ser. Math.* **43** (1980).
- [Ja2] \_\_\_\_\_, *Adding a 2-handle to a 3-manifold: An application to Property R*, *Proc. Amer. Math. Soc.* **92** (1984), 288–292.
- [Ko] T. Kobayashi, *Structures of the Haken manifolds with Heegaard splittings of genus two*, *Osaka J. Math.* **21** (1984), 437–455.
- [L1] S. Lee, *Dehn fillings yielding Klein bottles*, *Int. Math. Res. Not.* 2006, Art. ID 24253, 34pp.
- [L2] \_\_\_\_\_, *Klein bottle and toroidal Dehn fillings at distance 5*, *Pac. J. Math.* **247** (2010), 407–434.
- [L3] \_\_\_\_\_, *Lens spaces and toroidal Dehn fillings*, *Math. Z.* **267** (2011), 781–802.
- [LM] A. Lubotzky and A.R. Magid, *Varieties of representations of finitely generated groups*, *Mem. Amer. Math. Soc.* **58**, 1985.
- [Ma] B. Martelli, *A Python program for computing exceptional fillings on a finite volume cusped hyperbolic 3-manifold*, available at his web site: [people.dm.unipi.it/martelli/Dehn.html](http://people.dm.unipi.it/martelli/Dehn.html)
- [MP] B. Martelli and C. Petronio, *Dehn filling of the “magic” 3-manifold*, *Comm. Anal. Geom.* **14** (2006), 969–1026.
- [MS] D. Matignon and N. Sayari, *Klein slopes on hyperbolic 3-manifolds*, *Math. Proc. Cam. Phil. Soc.* **143** (2007), 419–447.
- [Mo] J.M. Montesinos, *Varietades de Seifert que son recubridores ciclicos ramificados de dos hojas*, *Bol. Soc. Math. Mexicana*, **18** (1973), 1–32.
- [Oe] U. Oertel, *Closed incompressible surfaces in complements of star links*, *Pacific Journal of Mathematics* **111** (1984), 209–230.
- [Oh] S. Oh, *Reducible and toroidal manifolds obtained by Dehn filling*, *Top. Appl.* **75** (1997), 93–104.
- [Rlf] D. Rolfsen, *Knots and links*, 2nd edition, Publish or Perish, 1990.
- [Rou] F. Roukema, *Exceptional slopes on manifolds of small complexity*, arXiv:1210.1824.
- [S] E. Sedgwick, *The Irreducibility of Heegaard splittings of Seifert fibered spaces*, *Pacific J. Math.* **190** (1999), 173–199.
- [V] L. Valdez-Sánchez, *Toroidal and Klein bottle boundary slopes*, *Topology Appl.* **154** (2007), 584–603.
- [Wu1] Y.-Q. Wu, *Incompressibility of surfaces in surgered 3-manifolds*, *Topology*, **31** (1992) 271–279.
- [Wu2] \_\_\_\_\_, *Dehn fillings producing reducible manifolds and toroidal manifolds*, *Topology* **37** (1998), 95–108.
- [Wu3] \_\_\_\_\_, *The classification of Dehn fillings on the outer torus of a 1-bridge braid exterior which produce solid tori*, *Math. Ann.* **330** (2004), 1–15.

DÉPARTEMENT DE MATHÉMATIQUES, UNIVERSITÉ DU QUÉBEC À MONTRÉAL, 201 AVENUE DU PRÉSIDENT-KENNEDY, MONTRÉAL, QC H2X 3Y7.

*Email address:* `boyer.steven@uqam.ca`

*URL:* <http://www.cirget.uqam.ca/boyer/boyer.html>

DEPARTMENT OF MATHEMATICS, UNIVERSITY OF TEXAS AT AUSTIN, 1 UNIVERSITY STATION, AUSTIN, TX 78712, USA.

*Email address:* `gordon@math.utexas.edu`

*URL:* <http://www.ma.utexas.edu/text/webpages/gordon.html>

DEPARTMENT OF MATHEMATICS, UNIVERSITY AT BUFFALO, BUFFALO, NY, 14214-3093, USA.

*Email address:* `xinzhang@buffalo.edu`

*URL:* <http://www.math.buffalo.edu/~xinzhang/>